

**National Construction
Code Series
2015
VOLUME TWO**

**Building Code of Australia
Class 1 and Class 10 Buildings**



2015

INTRODUCTION — CONTENTS AND FEATURES

© 2015 Australian Government and States and Territories of Australia

The *National Construction Code (NCC) 2015 (Volume One, Volume Two & Volume Three)* and the *Guide to Volume One* is the copyright of the Australian Government and States and Territories of Australia and, apart from any use as permitted under the Copyright Act 1968, no part may be reproduced without prior permission. Requests and enquiries concerning reproduction and rights should be directed in the first instance to the General Manager, Australian Building Codes Board, GPO Box 9839 Canberra ACT 2601.

The Australian Building Codes Board (ABCB) is established by agreement between the Commonwealth Government and each State and Territory Government. It is a co-operative arrangement between the signatories, local government and the building industry.

ABCB Important Disclaimer

While the ABCB has made every effort to ensure the Explanatory Information in this volume is accurate and up to date, such Explanatory Information does in no way constitute the provision of professional advice.

The ABCB gives no warranty or guarantee and accepts no legal liability whatsoever arising from or connected to, the accuracy, reliability, currency or completeness of any material contained in this volume.

Users should seek appropriate independent professional advice prior to relying on, or entering into any commitment based on material in this volume in relation to building or related activities. Its interpretation in no way overrides the approvals processes in any jurisdiction.

GENERAL TABLE OF CONTENTS

INTRODUCTION CONTENTS AND FEATURES

Introduction 8

SECTION 1 GENERAL REQUIREMENTS

1.0 Application 13
1.1 Interpretation 17
1.2 Acceptance of design and construction 32
1.3 Classification 34
1.4 Documents adopted by reference 37

SECTION 2 PERFORMANCE PROVISIONS

2.0 Application 50
2.1 Structure 51
2.2 Damp and weatherproofing 58
2.3 Fire safety 65
2.4 Health and amenity 72
2.5 Safe movement and access 77
2.6 Energy efficiency 82

SECTION 3 ACCEPTABLE CONSTRUCTION

3.0 How to use Section 3 96

PART 3.1 SITE PREPARATION

3.1.1 Earthworks 103
3.1.2 Drainage 107
3.1.3 Termite risk management 113

PART 3.2 FOOTINGS AND SLABS

3.2 Footings and slabs 126

INTRODUCTION — CONTENTS AND FEATURES

3.2.2	Preparation	129
3.2.3	Concrete and reinforcing	136
3.2.4	Site classification	140
3.2.5	Footing and slab construction	141
PART 3.3 MASONRY		
3.3	Definitions	154
3.3.1	Unreinforced masonry	155
3.3.2	Reinforced masonry	156
3.3.3	Masonry accessories	157
3.3.4	Weatherproofing of masonry	158
3.3.5	Earthwall construction	160
PART 3.4 FRAMING		
3.4.0	Framing	163
3.4.1	Sub-floor ventilation	166
3.4.2	Steel framing	171
3.4.3	Timber framing	179
3.4.4	Structural steel members	181
PART 3.5 ROOF AND WALL CLADDING		
3.5.1	Roof cladding	197
3.5.2	Gutters and downpipes	209
3.5.3	Wall cladding	214
PART 3.6 GLAZING		
3.6	Glazing	225
PART 3.7 FIRE SAFETY		
3.7.1	Fire separation	239
3.7.2	Smoke alarms	262
3.7.3	Heating appliances	267

INTRODUCTION — CONTENTS AND FEATURES

3.7.4	Bushfire areas	275
3.7.5	Alpine areas	290
PART 3.8 HEALTH AND AMENITY		
3.8.1	Wet areas and external waterproofing	296
3.8.2	Room heights	303
3.8.3	Facilities	305
3.8.4	Light	308
3.8.5	Ventilation	313
3.8.6	Sound insulation	316
PART 3.9 SAFE MOVEMENT AND ACCESS		
3.9.1	Stair construction	337
3.9.2	Barriers and handrails	344
3.9.3	Swimming pool access	353
3.9.4	Swimming pool water recirculation systems	354
PART 3.10 ADDITIONAL CONSTRUCTION REQUIREMENTS		
3.10.1	High wind areas	358
3.10.2	Earthquake areas	363
3.10.3	Flood hazard areas	364
PART 3.11 STRUCTURAL DESIGN MANUALS		
3.11	Structural design manuals	368
PART 3.12 ENERGY EFFICIENCY		
3.12	Energy efficiency	376
3.12.1	Building fabric	384
3.12.2	External glazing	408
3.12.3	Building sealing	424
3.12.4	Air movement	427
3.12.5	Services	429

INTRODUCTION — CONTENTS AND FEATURES

APPENDIX A ADDITIONS

Commonwealth of Australia	441
Australian Capital Territory	445
New South Wales	471
Northern Territory	486
Queensland	490
South Australia	492
Tasmania	502
Victoria	506
Western Australia	511

INDEX, ABBREVIATIONS AND SYMBOLS

Index	518
Abbreviations and symbols	535

HISTORY OF AMENDMENTS

History of amendments	539
-----------------------------	-----

LIST OF AMENDMENTS

List of amendments	558
--------------------------	-----

INTRODUCTION

THE NATIONAL CONSTRUCTION CODE SERIES

The National Construction Code Series (NCC) is an initiative of the Council of Australian Governments developed to incorporate all on-site construction requirements into a single code. The Building Code of Australia (BCA) is Volume One and Volume Two of the NCC.

FORMAT

The NCC is published in three volumes:

VOLUME ONE:

pertains primarily to Class 2 to 9 buildings.

VOLUME TWO:

pertains primarily to Class 1 and 10 buildings (houses, sheds, carports, etc).

VOLUME THREE:

pertains primarily to plumbing and drainage associated with all classes of buildings.

All three volumes are drafted in a performance format allowing a choice of *Deemed-to-Satisfy Provisions* or flexibility to develop *Alternative Solutions* based on existing or new innovative building, plumbing and drainage products, systems and designs.

When complying with the *Deemed-to-Satisfy Provisions*, or when developing an *Alternative Solution* in order to comply with the BCA, consideration may need to be given to whether the *Building Solution* impacts on compliance with the Plumbing Code of Australia (PCA).

THE BUILDING CODE OF AUSTRALIA

The BCA is produced and maintained by the Australian Building Codes Board (ABCB) on behalf of the Australian Government and each State and Territory government.

The BCA is a uniform set of technical provisions for the design and construction of buildings and other structures throughout Australia. It allows for variations in climate and geological or geographic conditions.

THE AUSTRALIAN BUILDING CODES BOARD

The ABCB is established by agreement between the Australian Government and each State and Territory Government. It is a co-operative arrangement between the signatories, local government and the building industry.

The ABCB's mission is to address issues relating to safety, health, amenity and sustainability in the design, construction and performance of buildings. This is achieved through the NCC and the development of effective regulatory systems and appropriate non-regulatory solutions.

The Board comprises—

- (a) a Chair; and
- (b) the head of each Commonwealth, State and Territory department, statutory body, division, or agency that has the relevant administrative responsibility for NCC matters; and
- (c) a representative of the Australian Local Government Association (ALGA); and

- (d) representatives of the building and construction industry, including one representative with plumbing expertise.

The Building Codes Committee (BCC) is the peak technical advisory body to the ABCB, with responsibility for technical matters associated with the BCA.

The BCC comprises—

- (a) a representative of the ABCB; and
- (b) one nominee each of the Australian, State and Territory Government members of the ABCB; and
- (c) representatives of the building and construction industry.

THE BCA — CONTENT

GOALS

The goal of the BCA is to enable the achievement of nationally consistent, minimum necessary standards of relevant safety (including structural safety and safety from fire), health, amenity and sustainability objectives efficiently.

This goal is applied so that—

- (a) there is a rigorously tested rationale for the regulation; and
- (b) the regulation is effective and proportional to the issues being addressed such that the regulation will generate benefits to society greater than the costs (that is, net benefits); and
- (c) there is no regulatory or non-regulatory alternative (whether under the responsibility of the Board or not) that would generate higher net benefits; and
- (d) the competitive effects of the regulation have been considered and the regulation is no more restrictive than necessary in the public interest.

STATE AND TERRITORY VARIATIONS AND ADDITIONS

Each State's and Territory's legislation adopts the BCA subject to the variation or deletion of some of its provisions, or the addition of extra provisions. In the *Housing Provisions*, these are divided into two types:

- (a) A variation to the *Housing Provisions* — these are identified following the provision that is being varied.
- (b) Additional requirements — these are contained in Appendix A.

SCOPE OF THE HOUSING PROVISIONS

Users of the *Housing Provisions* need to be aware that the acceptable construction practices contained in this document do not cover all types of Class 1 and 10 buildings. The limitations of the acceptable construction practices are discussed in the introduction to Section 3.

DEFINITIONS

Words with special meanings are printed in italics and are defined in **1.1.1** or, if they are specific to a Part, at the start of that Part in Section 3. Defined terms which appear in figures and diagrams may not be in italics.

LEGISLATIVE ARRANGEMENTS

GENERAL

The BCA is given legal effect by building regulatory legislation in each State and Territory. This legislation consists of an Act of Parliament and subordinate legislation which empowers the

regulation of certain aspects of buildings and structures, and contains the administrative provisions necessary to give effect to the legislation.

Any provision of the BCA may be overridden by, or subject to, State or Territory legislation. The BCA must therefore be read in conjunction with that legislation. Any queries on such matters should be referred to the State or Territory authority responsible for building regulatory matters.

BCA ADOPTION

The adoption of the BCA is addressed in **Part 1.0** of the *Housing Provisions*.

DOCUMENTATION OF DECISIONS

Decisions made under the BCA should be fully documented and copies of all relevant documentation should be retained.

Examples of the kind of documentation which should be prepared and retained include:

- (a) Details of the *Building Solution* including all relevant plans and other supporting documentation.
- (b) In cases where an *Alternative Solution* has been proposed—
 - (i) details of the relevant *Performance Requirements*; and
 - (ii) the *Assessment Method* or methods used to establish compliance with the relevant *Performance Requirements*; and
 - (iii) details of any *Expert Judgement* relied upon including the extent to which the judgement was relied upon and the qualifications and experience of the expert; and
 - (iv) details of any tests or calculations used to determine compliance with the relevant *Performance Requirements*; and
 - (v) details of any Standards or other information which were relied upon.

STRUCTURE

The BCA has been structured as set out in **1.0.3** and shown in **Figure 1.0.3**. It is the ABCB's intent that the *Objectives* and *Functional Statements* be used as an aid to the interpretation of the BCA and not for determining compliance with the BCA.

FURTHER DEVELOPMENT

Regular amendments are planned to the BCA to improve clarity of provisions, upgrade referenced documents and to reflect the results of research and improved technology.

GENERAL REQUIREMENTS

- 1.0 Application**
- 1.1 Interpretation**
- 1.2 Acceptance of Design and Construction**
- 1.3 Classification**
- 1.4 Documents Adopted by Reference**

SECTION 1 CONTENTS

SECTION 1 GENERAL REQUIREMENTS

1.0 Application

- 1.0.1 Adoption
- 1.0.2 BCA Volumes
- 1.0.3 BCA Structure
- 1.0.4 Compliance with the BCA
- 1.0.5 Meeting the Performance Requirements
- 1.0.6 Objectives and Functional Statements
- 1.0.7 Deemed-to-Satisfy Provisions
- 1.0.8 Alternative Solutions
- 1.0.9 Assessment Methods
- 1.0.10 Relevant Performance Requirements

1.1 Interpretation

- 1.1.1 Definitions
- 1.1.2 Adoption of referenced documents
- 1.1.3 Context of reference
- 1.1.4 Differences between referenced documents and the Housing Provisions
- 1.1.5 Application of the Housing Provisions to a particular State or Territory
- 1.1.6 Language
- 1.1.7 Interpretation of diagrams
- 1.1.8 Explanatory information

1.2 Acceptance of design and construction

- 1.2.1 Suitability of materials
- 1.2.2 Evidence of suitability
- 1.2.3 Fire resistance of building elements
- 1.2.4 Fire hazard properties

1.3 Classification

- 1.3.1 Principles of classification
- 1.3.2 Classification
- 1.3.3 Multiple classifications

1.4 Documents adopted by reference

- 1.4.1 Schedule of referenced documents

PART 1.0 APPLICATION

1.0.1 Adoption

The dates of adoption of the Building Code of Australia (Volume Two) and its amendments are shown in the “History of BCA Adoption” division at the end of this Volume.

1.0.2 BCA Volumes

- (a) The Building Code of Australia consists of two volumes, Volume One and Volume Two.
- (b) This is Volume Two of the Building Code of Australia (hereafter described as the *Housing Provisions*) which contains the requirements for—
 - (i) Class 1 and 10a buildings (other than access requirements for people with a disability in Class 1b and 10a buildings); and
 - (ii) certain Class 10b structures (other than access requirements for people with a disability in Class 10b *swimming pools*); and
 - (iii) Class 10c *private bushfire shelters*.(Refer to **Part 1.3** for a full description of the Class 1 and 10 building classifications).
- (c) Volume One contains the requirements for—
 - (i) all Class 2 to 9 buildings; and
 - (ii) access requirements for people with a disability in Class 1b and 10a buildings; and
 - (iii) certain Class 10b structures including access requirements for people with a disability in Class 10b *swimming pools*.

1.0.3 BCA Structure

The structure of the BCA comprises the following as shown in **Figure 1.0.3**:

- (a) The *Objectives*.
- (b) The *Functional Statements*.
- (c) The *Performance Requirements* with which all *Building Solutions* must comply.
- (d) The *Building Solutions*.

GENERAL REQUIREMENTS

Figure 1.0.3

THE BCA HIERARCHY

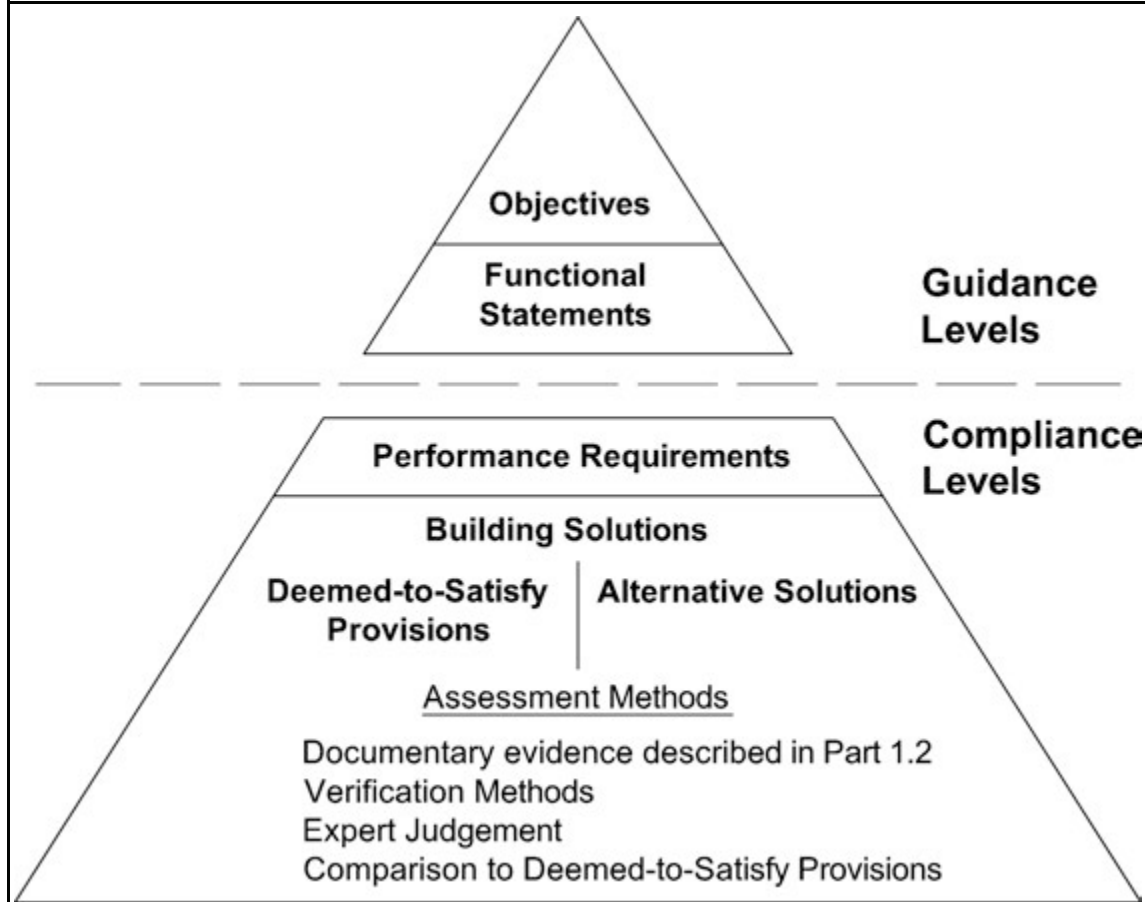

1.0.4 Compliance with the BCA

A *Building Solution* will comply with the BCA if it satisfies the *Performance Requirements*.

1.0.5 Meeting the Performance Requirements

Compliance with the *Performance Requirements* can only be achieved by—

- (a) complying with the *Deemed-to-Satisfy Provisions*; or
- (b) formulating an *Alternative Solution* which—
 - (i) complies with the *Performance Requirements*; or
 - (ii) is shown to be at least *equivalent* to the *Deemed-to-Satisfy Provisions*; or
- (c) a combination of (a) and (b).

1.0.6 Objectives and Functional Statements

The *Objectives* and *Functional Statements* may be used as an aid to interpretation.

GENERAL REQUIREMENTS

1.0.7 Deemed-to-Satisfy Provisions

- (a) A *Building Solution* which complies with the *Deemed-to-Satisfy Provisions* is deemed to comply with the *Performance Requirements*.
- (b) Where an acceptable construction manual and an acceptable construction practice contained in the same Part of **Section 3** are deemed to satisfy the same component of a *Performance Requirement*, in order to comply with the *Deemed-to-Satisfy Provisions* it is only necessary to satisfy—
 - (i) the appropriate acceptable construction manual; or
 - (ii) the appropriate acceptable construction practice.
- (c) Where an acceptable construction manual and an acceptable construction practice contained in the same Part of **Section 3** are deemed to satisfy different components of a *Performance Requirement*, compliance with the *Deemed-to-Satisfy Provisions* may require satisfying both the listed acceptable construction manual and the acceptable construction practice for their specific components.

1.0.8 Alternative Solutions

- (a) An *Alternative Solution* must be assessed according to one or more of the *Assessment Methods*.
- (b) An *Alternative Solution* will only comply with the BCA if the *Assessment Methods* used to determine compliance with the *Performance Requirements* have been satisfied.
- (c) The *Performance Requirements* relevant to an *Alternative Solution* must be determined in accordance with **1.0.10**.

1.0.9 Assessment Methods

The following *Assessment Methods*, or any combination of them, can be used to determine that a *Building Solution* complies with the *Performance Requirements*:

- (a) Evidence to support that the use of a material, form of construction or design meets a *Performance Requirement* or a *Deemed-to-Satisfy Provision* as described in **1.2.2**.
- (b) *Verification Methods* such as—
 - (i) the *Verification Methods* in the BCA; or
 - (ii) such other *Verification Methods* as the *appropriate authority* accepts for determining compliance with the *Performance Requirements*.
- (c) Comparison with the *Deemed-to-Satisfy Provisions*.
- (d) *Expert Judgement*.

1.0.10 Relevant Performance Requirements

The following method must be used to determine the *Performance Requirement* or *Performance Requirements* relevant to an *Alternative Solution*:

- (a) Identify the relevant *Deemed-to-Satisfy Provision* of Section 3 that is to be the subject of the *Alternative Solution*.
- (b) Identify the *Performance Requirements* from Section 2 that are relevant to the identified *Deemed-to-Satisfy Provisions*.

GENERAL REQUIREMENTS

- (c) Identify *Performance Requirements* from other parts of Section 2 that are relevant to any aspects of the *Alternative Solution* proposed or that are affected by the application of the *Deemed-to-Satisfy Provisions*, that are the subject of the *Alternative Solution*.

PART 1.1 INTERPRETATION

1.1.1 Definitions

1.1.1.1 In the *Housing Provisions*, definitions are contained as follows:

- (a) In 1.1.1 for definitions that apply to all of the *Housing Provisions*.
- (b) In each Part (as applicable) for definitions that apply to that Part only.

1.1.1.2 In the *Housing Provisions*, unless the contrary appears:

Alpine area means land—

- (a) likely to be subject to significant snowfalls; and
- (b) in New South Wales, ACT or Victoria more than 1200 m above the Australian Height Datum; and
- (c) in Tasmania more than 900 m above the Australian Height Datum.

Explanatory information:

See [Part 3.7.5](#) for map of *alpine areas*.

Alteration, in relation to a building, includes an addition or extension to a building.

Alternative Solution means a *Building Solution* which complies with the *Performance Requirements* other than by reason of complying with the *Deemed-to-Satisfy Provisions*.

Appropriate authority means the relevant authority with the statutory responsibility to determine the particular matter.

STATE AND TERRITORY VARIATIONS

Definition of appropriate authority has been replaced in New South Wales as follows:

Appropriate authority means the relevant authority with the responsibility to determine the particular matter.

Assessment Method means a method used for determining or establishing that a *Building Solution* complies with the *Performance Requirements*.

Automatic, applied to a fire door, smoke door, solid core door, fire shutter, fire *window*, smoke-and-heat vent, sprinkler system, alarm system or the like, means designed to operate when activated by a heat, smoke or fire sensing device.

Average recurrence interval applied to rainfall, means the average or expected interval between exceedances for a 5 minute duration rainfall intensity.

Building Solution means a solution which complies with the *Performance Requirements* and is—

- (a) an *Alternative Solution*; or
- (b) a solution which complies with the *Deemed-to-Satisfy Provisions*; or
- (c) a combination of (a) and (b).

GENERAL REQUIREMENTS

Breaking surf means any area of salt water in which waves break on an average of at least 4 days per week but does not include white caps or choppy water.

Explanatory information:

Breaking surf normally occurs in areas exposed to the open sea. *Breaking surf* does not normally occur in sheltered areas, such as that which occurs around Port Phillip Bay, Sydney Harbour, Swan River, Derwent River and similar locations.

STATE AND TERRITORY VARIATIONS

In South Australia insert brush fence as follows:

Brush fence means a fence or gate that is primarily constructed of Broombrush (*Melaleuca Uncinata*).

Cavity means a void between 2 leaves of masonry, or in masonry veneer construction, a void between a leaf of masonry and the supporting frame.

Cavity wall, for the purposes of **V2.2.1**, means a wall that incorporates a drained cavity.

Certificate of Accreditation means a certificate issued by a State or Territory accreditation authority stating that the properties and performance of a building material or method of construction or design fulfil specific requirements of the *Housing Provisions*.

Certificate of Conformity means a certificate issued under the ABCB scheme for products and systems certification stating that the properties and performance of a building material or method of construction or design fulfil specific requirements of the *Housing Provisions*.

Climate zone, for the purposes of **Part 2.6** and **Part 3.12**, means an area defined in **Figure 1.1.4** and in **Table 1.1.2** for specific locations, having energy efficiency provisions based on a range of similar climatic characteristics.

GENERAL REQUIREMENTS

Figure 1.1.4

CLIMATE ZONES FOR THERMAL DESIGN

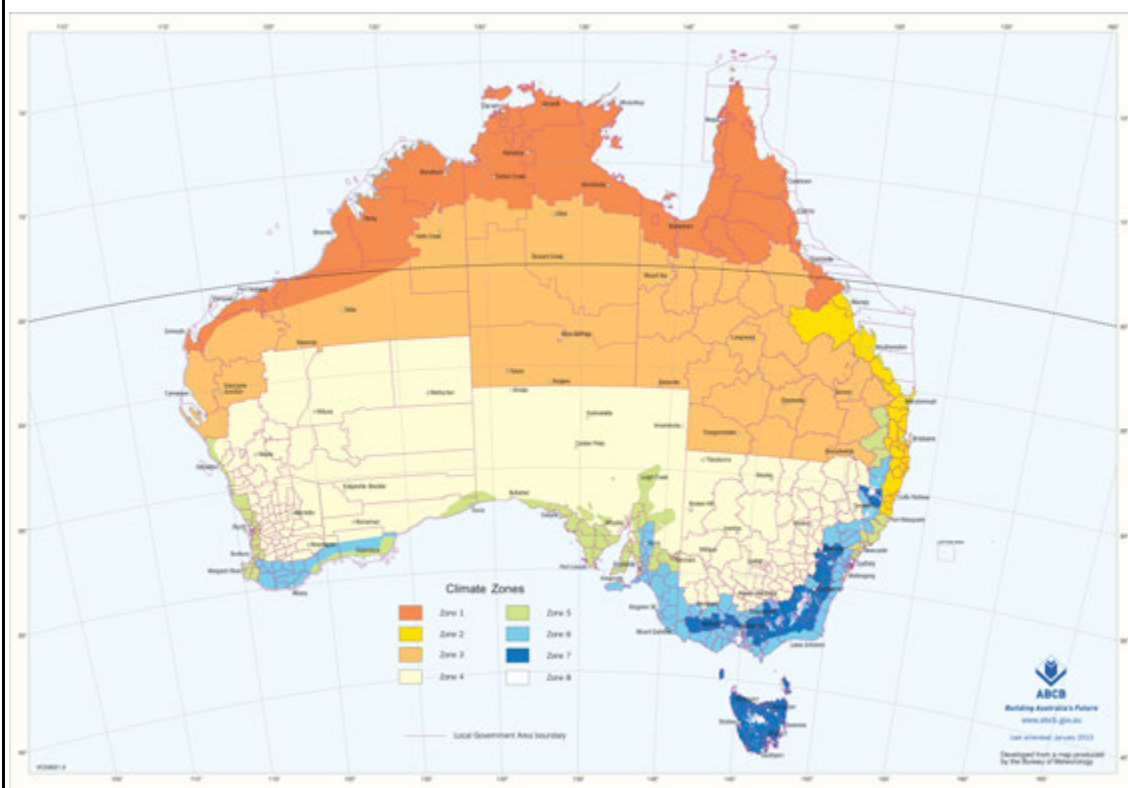

Notes:

1. This map can be viewed in enlargeable form on the Energy Efficiency page of the ABCB web site at www.abcb.gov.au.
2. A Zone 4 area in South Australia, other than a council area, at an altitude greater than 300 m above Australian Height Datum, is to be considered as Zone 5.
 These areas have been defined in an enlarged format on the following maps produced by the Department of Planning, Transport and Infrastructure:
 - Adelaide Hills Council Climate Zone Map**
 - Barossa Council Climate Zone Map**
 - Regional Council of Goyder Climate Zone Map**
 These maps can be viewed on the Government of South Australia website at www.sa.gov.au
3. Locations in *climate zone 8* are in *alpine areas*.

GENERAL REQUIREMENTS

Table 1.1.2 CLIMATE ZONES FOR THERMAL DESIGN — VARIOUS LOCATIONS

Location	Climate zone	Location	Climate zone	Location	Climate zone	Location	Climate zone
Australian Capital Territory				Canberra	7		
New South Wales							
Albury	4	Byron Bay	2	Lord Howe Island	2	Tamworth	4
Armidale	7	Cobar	4	Moree	4	Thredbo	8
Batemans Bay	6	Coffs Harbour	2	Newcastle	5	Wagga Wagga	4
Bathurst	7	Dubbo	4	Nowra	6	Williamtown	5
Bega	6	Goulburn	7	Orange	7	Wollongong	5
Bellingen Shire - Dorrigo Plateau	7	Grafton	2	Perisher Smiggins	8	Yass	6
Bellingen Shire - Valley & Seaboard	2	Griffith	4	Port Macquarie	5		
Bourke	4	Ivanhoe	4	Sydney - East	5		
Broken Hill	4	Lismore	2	Sydney - West	6		
Northern Territory							
Alice Springs	3	Elliot	3	Renner Springs	3		
Darwin	1	Katherine	1	Tennant Creek	3		
Queensland							
Birdsville	3	Cunnamulla	3	Maryborough	2	Toowoomba	5
Brisbane	2	Longreach	3	Mount Isa	3	Torrens Creek	3
Bundaberg	2	Gladstone	2	Normanton	1	Townsville	1
Cairns	1	Labrador	2	Rockhampton	2	Warwick	5
Cooktown	1	Mackay	2	Roma	3	Weipa	1
South Australia							
Adelaide	5	Kingscote	6	Marree	4	Port Lincoln	5
Bordertown	6	Leigh Creek	5	Mount Gambier	6	Renmark	5
Ceduna	5	Lobethal	6	Murray Bridge	6	Tarcoola	4
Cook	4	Loxton	5	Oodnadatta	4	Victor Harbour	6
Elliston	5	Naracoorte	6	Port Augusta	4	Whyalla	4
Tasmania							
Burnie	7	Flinders Island	7	Launceston	7	Rossarden	7
Bicheno	7	Hobart	7	New Norfolk	7	Smithton	7
Deloraine	7	Huonville	7	Oatlands	7	St Marys	7
Devonport	7	King Island	7	Orford	7	Zeehan	7

GENERAL REQUIREMENTS

Table 1.1.2 CLIMATE ZONES FOR THERMAL DESIGN — VARIOUS LOCATIONS — continued

Location	Climate zone	Location	Climate zone	Location	Climate zone	Location	Climate zone
Victoria							
Anglesea	6	Bright	7	Horsham	6	Swan Hill	4
Ararat	7	Colac	6	Melbourne	6	Traralgon	6
Bairnsdale	6	Dandenong	6	Mildura	4	Wangaratta	7
Ballarat	7	Echuca	4	Portland	6	Warrnambool	6
Benalla	6	Geelong	6	Sale	6	Wodonga	6
Bendigo	6	Hamilton	7	Shepparton	4		
Western Australia							
Albany	6	Cocos Island	1	Kalgoorlie-Boulder	4	Port Hedland	1
Balladonia	4	Derby	1	Karratha	1	Wagin	4
Broome	1	Esperance	5	Meekatharra	4	Wyndham	1
Bunbury	5	Exmouth	1	Northam	4		
Carnarvon	3	Geraldton	5	Pemberton	6		
Christmas Island	1	Halls Creek	3	Perth	5		

Combustible —

- (a) applied to a material — means *combustible* under AS 1530.1; or
- (b) applied to construction or part of a building — means constructed wholly or in part of *combustible* materials.

Common wall means a wall that is common to adjoining buildings other than Class 1 buildings.

Construction activity actions means actions due to stacking of building materials or the use of equipment, including cranes and trucks, during construction or actions which may be induced by floor-to-floor propping.

Damp-proof course (DPC) means a continuous layer of impervious material placed in a masonry wall or pier, or between a wall or pier and a floor, to prevent the upward or downward migration of water.

Deemed-to-Satisfy Provisions means provisions contained in Section 3 which are deemed to comply with the *Performance Requirements*.

Defined flood event (DFE) means the flood event selected for the management of flood hazard for the location of specific development as determined by the *appropriate authority*.

Defined flood level (DFL) means the flood level associated with a *defined flood event* relative to a specified datum (see **Figure 1.1.5**).

GENERAL REQUIREMENTS

Figure 1.1.5

IDENTIFICATION OF DEFINED FLOOD LEVEL, FLOOD HAZARD LEVEL AND FREEBOARD

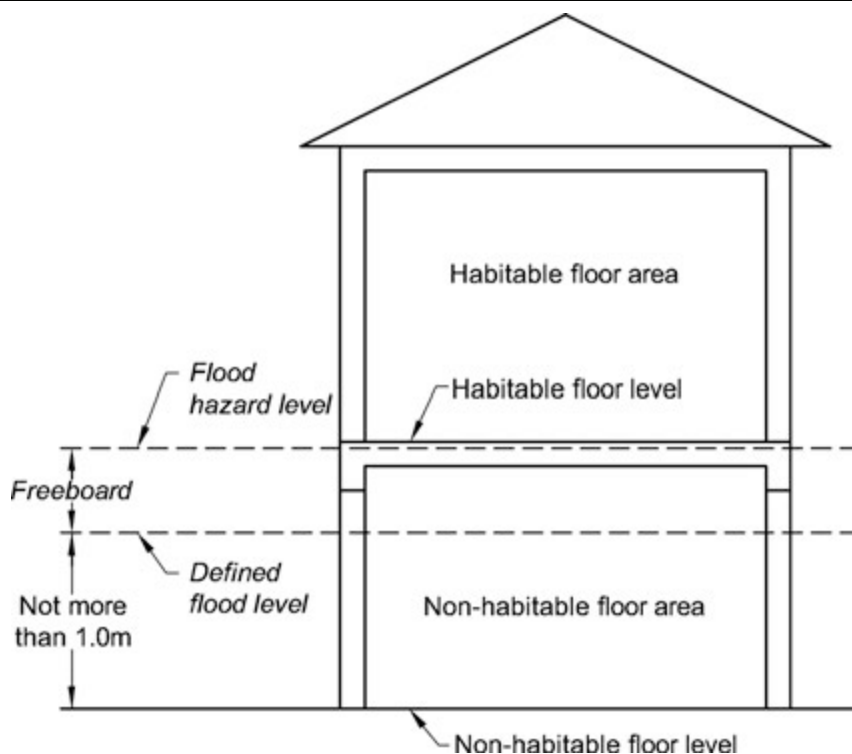

Designated bushfire prone area means land which has been designated under a power in legislation as being subject, or likely to be subject, to bushfires.

STATE AND TERRITORY VARIATIONS

Definition of designated bushfire prone area has been replaced in New South Wales as follows:

Designated bushfire prone area means land that:

- has been designated under legislation; or
- has been identified under an environmental planning instrument, development control plan or in the course of processing and determining a development application,

as land that can support a bushfire or is likely to be subject to bushfire attack.

Design wind speed means the design gust wind speed for the area where the building is located, calculated in accordance with AS/NZS 1170.2 or AS 4055 (see [Table 1.1.1](#) for wind classes).

GENERAL REQUIREMENTS

Table 1.1.1 WIND CLASSES

Wind Classes									
Non-cyclonic Region A and B						Cyclonic Region C and D			
N1	N2	N3	N4	N5	N6	C1	C2	C3	C4
Notes:									
1. Wind classification map identifying wind regions is contained in Part 3.10.1 (see Figure 3.10.1.4).									
2. Information on wind classes for particular areas may be available from the <i>appropriate authority</i> .									
3. Shaded areas denote wind classes covered by Part 3.10.1 , High Wind Areas.									
4. "N" = non-cyclonic winds and "C" = cyclonic winds.									

Direct fix cladding wall, for the purposes of [V2.2.1](#), means a wall with cladding attached directly to the wall framing without the use of a drained cavity.

Domestic services means the basic engineering systems that use energy or control the use of energy; and—

- (a) includes—
 - (i) heating, air-conditioning, mechanical ventilation and artificial lighting; and
 - (ii) pumps and heaters for *swimming pools* and spa pools; and
 - (iii) heated water systems; but
- (b) excludes cooking facilities and portable appliances.

Envelope, for the purposes of [Part 2.6](#) and [Part 3.12](#), means the parts of a building's *fabric* that separate artificially heated or cooled spaces from—

- (a) the exterior of the building; or
- (b) other spaces that are not artificially heated or cooled.

Equivalent means equivalent to the level of health, safety and amenity provided by the *Deemed-to-Satisfy Provisions*.

Expert Judgement means the judgement of an expert who has the qualifications and experience to determine whether a *Building Solution* complies with the *Performance Requirements*.

External wall means an outer wall of a building which is not a *separating wall*.

Fabric, for the purposes of [Part 2.6](#) and [Part 3.12](#), means the basic building structural elements and components of a building including the roof, ceilings, walls and floors.

GENERAL REQUIREMENTS

Fire-resistance level (FRL) means the grading periods in minutes determined in accordance with **Specification A2.3** of BCA Volume One, for—

- (a) *structural adequacy*; and
- (b) *integrity*; and
- (c) *insulation*,

and expressed in that order.

Explanatory information:

A dash means there is no requirement for that criterion. For example, 90/–/– means there is no FRL for integrity and insulation.

Fire-resisting, applied to a *structural member* or other part of a building, means having the FRL *required* for that *structural member* or other part.

Flammability Index means the index number determined under AS 1530.2.

Flashing means a strip or sleeve of impervious material dressed, fitted or built-in to provide a barrier to moisture movement, or to divert the travel of moisture, or to cover a joint where water would otherwise penetrate to the interior of a building.

Flood hazard area means the *site* (whether or not mapped) encompassing land lower than the *flood hazard level* which has been determined by the *appropriate authority*.

STATE AND TERRITORY VARIATIONS

In Victoria the definition of flood hazard area is replaced as follows:

Flood hazard area means the *site* (whether or not mapped) encompassing land in an area liable to flooding within the meaning of Regulation 802 of the Building Regulations 2006.

Flood hazard level (FHL) means the flood level used to determine the height of floors in a building and represents the *defined flood level* plus the *freeboard* (see **Figure 1.1.5**).

Floor area means, in relation to a room, the area of the room measured within the finished surfaces of the walls, and includes the area occupied by any cupboard or other built-in furniture, fixture or fitting (see **Figure 1.1.1**).

Figure 1.1.1

IDENTIFICATION OF FLOOR AREA OF A ROOM

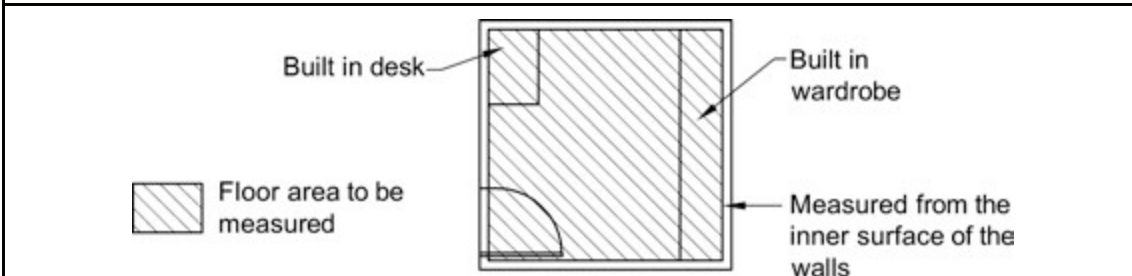

Foundation means the ground which supports the building (see **Figure 1.1.2**).

GENERAL REQUIREMENTS

Figure 1.1.2

IDENTIFICATION OF FOUNDATION

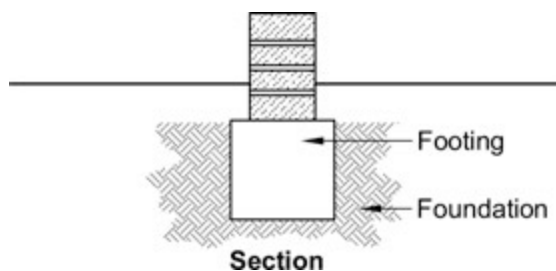

Freeboard means the height above the *defined flood level* as determined by the *appropriate authority*, used to compensate for effects such as wave action and localised hydraulic behaviour (see [Figure 1.1.5](#)).

STATE AND TERRITORY VARIATIONS

In Victoria the definition of freeboard is replaced as follows:

Freeboard means the minimum height of the level of the lowest floor of a building above the *defined flood level*, regulated by the relevant planning scheme, or specified or otherwise determined by the relevant council under Regulation 802 of the Building Regulations 2006 (see [Figure 1.1.5](#)).

Functional Statement means a statement which describes how buildings and building elements achieve the *Objectives*.

Glazing, for the purposes of [Part 2.6](#) and [Part 3.12](#), means a transparent or translucent element and its supporting frame located in the external *fabric* of the building, and includes a *window* other than a *roof light*.

Habitable room means a room used for normal domestic activities, and—

- (a) includes a bedroom, living room, lounge room, music room, television room, kitchen, dining room, sewing room, study, playroom, family room, home theatre and sunroom; but
- (b) excludes a bathroom, laundry, water closet, pantry, walk-in wardrobe, corridor, hallway, lobby, photographic darkroom, clothes-drying room, and other spaces of a specialised nature occupied neither frequently nor for extended periods.

High wind area means a region that is subject to *design wind speeds* more than N3 or C1 (see [Table 1.1.1](#)).

Housing Provisions means the requirements for Class 1 and 10 buildings contained in Volume Two of the Building Code of Australia as published by the Australian Building Codes Board.

Illuminance means the luminous flux falling onto a unit area of surface.

Insulation, in relation to an FRL, means the ability to maintain a temperature on the surface not exposed to the furnace below the limits specified in AS 1530.4.

Integrity, in relation to an FRL, means the ability to resist the passage of flames and hot gases specified in AS 1530.4.

Internal wall excludes a *separating wall*, *common wall* or party wall.

GENERAL REQUIREMENTS

Lightweight construction means construction which incorporates or comprises—

- (a) sheet or board material, plaster, render, sprayed application, or other material similarly susceptible to damage by impact, pressure or abrasion; or
- (b) concrete and concrete products containing pumice, perlite, vermiculite, or other soft material similarly susceptible to damage by impact, pressure or abrasion; or
- (c) masonry having a thickness less than 70 mm.

Loadbearing means intended to resist vertical forces additional to those due to its own weight.

Low rainfall intensity area means an area with a 5 minute rainfall intensity for an *average recurrence interval* of 20 years of not more than 125 mm/hour.

Explanatory information:

Rainfall intensity figures can be obtained from [Table 3.5.2.1](#).

Non-combustible —

- (a) applied to a material — means not deemed *combustible* under AS 1530.1 — Combustibility Tests for Materials; and
- (b) applied to construction or part of a building — means constructed wholly of materials that are not deemed *combustible*.

Objective means a statement contained in the BCA which is considered to reflect community expectations.

Other property means all or any of the following—

- (a) any building, whether or not on the same or an adjoining allotment; and
- (b) any adjoining allotment; and
- (c) a road.

Outdoor air means air outside the building.

Outfall means that part of the disposal system receiving *surface water* from the drainage system and may include a natural water course, kerb and channel, or soakage system.

Performance Requirement means a requirement which states the level of performance which a *Building Solution* must meet.

Private bushfire shelter means a structure associated with, but not attached to, or part of a Class 1a dwelling that may, as a last resort, provide shelter for occupants from immediate life threatening effects of a bushfire.

Private garage means—

- (a) any garage associated with a Class 1 building; or
- (b) any separate single storey garage associated with another building where such garage contains not more than 3 vehicle spaces.

GENERAL REQUIREMENTS

Professional engineer means a person who is—

- (a) if legislation is applicable — a registered *professional engineer* in the relevant discipline who has appropriate experience and competence in the relevant field; or
- (b) if legislation is not applicable—
 - (i) a Corporate Member of the Institution of Engineers, Australia; or
 - (ii) eligible to become a Corporate Member of the Institution of Engineers, Australia, and has appropriate experience and competence in the relevant field.

Registered Testing Authority means—

- (a) an organisation registered by the National Association of Testing Authorities (NATA) to test in the relevant field; or
- (b) an organisation outside Australia registered by an authority recognised by NATA through a mutual recognition agreement; or
- (c) an organisation recognised as being a *Registered Testing Authority* under legislation at the time the test was undertaken.

Renewable energy means energy that is derived from sources that are regenerated, replenished, or for all practical purposes cannot be depleted and the energy sources include, but are not limited to, solar, wind, hydroelectric, wave action and geothermal.

Required means required to satisfy a *Performance Requirement* or a *Deemed-to-Satisfy Provision* of the *Housing Provisions* as appropriate.

Roof light , for the purposes of **Part 2.6**, **Part 3.8.4** and **Part 3.12**, means a skylight, *window* or the like installed in a roof—

- (a) to permit natural light to enter the room below; and
- (b) at an angle between 0 and 70 degrees measured from the horizontal plane.

Sanitary compartment means a room or space containing a closet pan or urinal (see **Figure 1.1.6**).

Figure 1.1.6

IDENTIFICATION OF A SANITARY COMPARTMENT

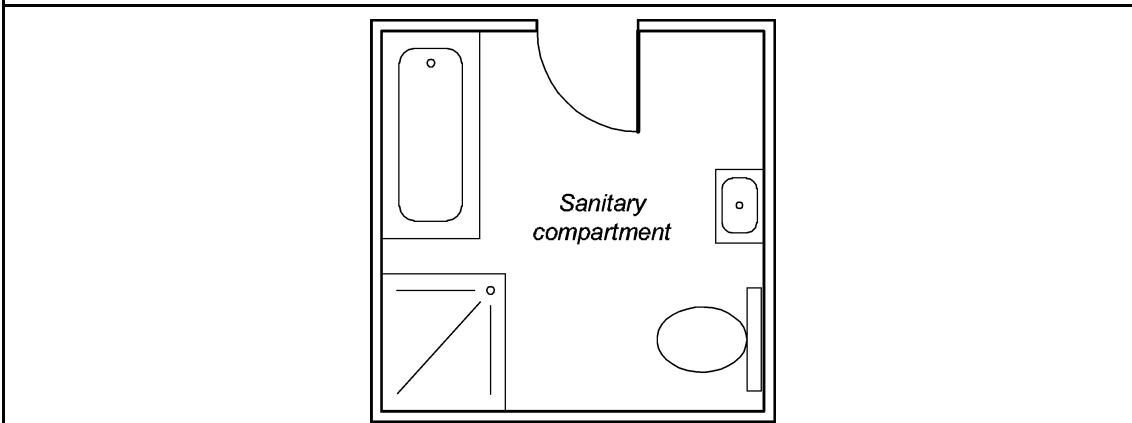

GENERAL REQUIREMENTS

Figure 1.1.6

IDENTIFICATION OF A SANITARY COMPARTMENT

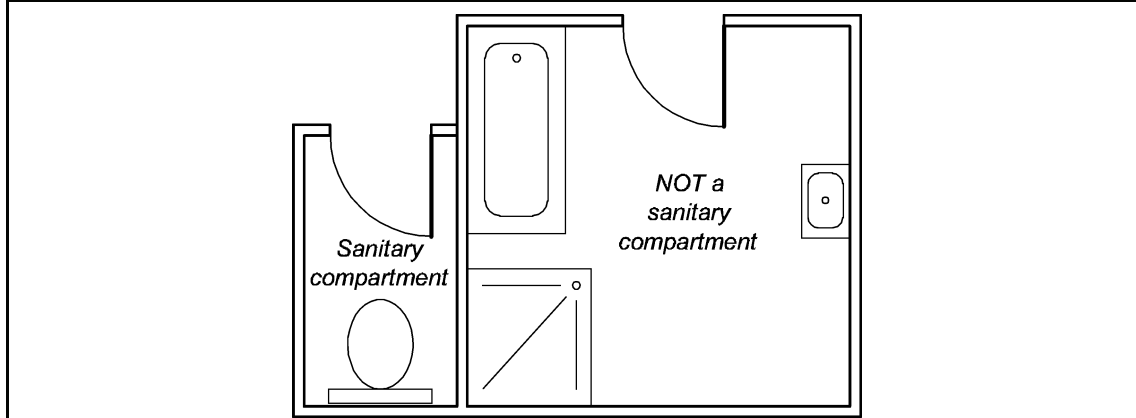

Sarking-type material means a material such as a *reflective insulation* or other flexible membrane of a type normally used for a purpose such as waterproofing, vapour proofing or thermal reflectance.

Self-closing, applied to a door or *window* means equipped with a device which returns the door or *window* to the fully closed and latched position immediately after each manual opening.

Separating wall means a wall that is common to adjoining Class 1 buildings (see [Figure 1.1.3](#)).

Figure 1.1.3

SEPARATING WALL

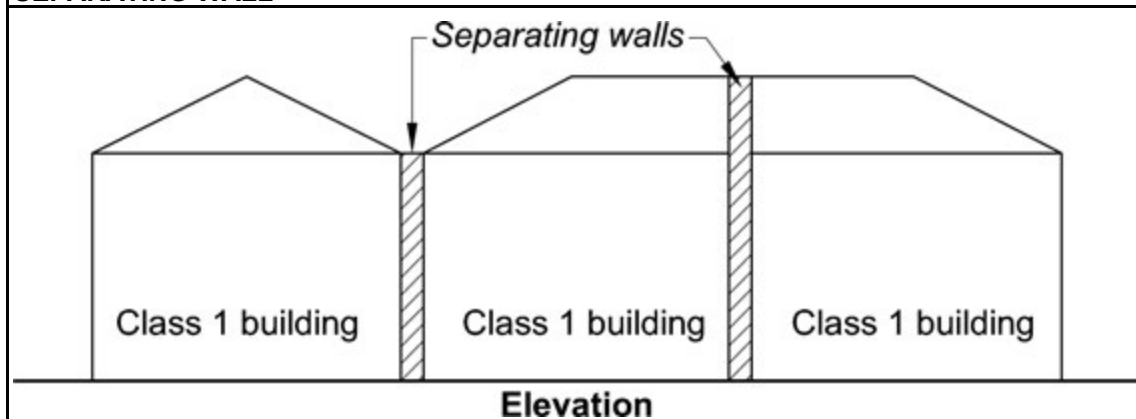

Note: May also be known as a party wall and typically is *required* to be *fire-resisting* construction (see [Part 3.7.1](#)).

Site means the part of the allotment of land on which a building stands or is to be erected.

Sitework means work on or around a *site*, including earthworks, preparatory to or associated with the construction, *alteration*, demolition or removal of a building.

GENERAL REQUIREMENTS

Smoke-Developed Index means the index number for smoke developed under AS/NZS 1530.3.

Spread-of-Flame Index means the index number for spread of flame under AS/NZS 1530.3.

Standard Fire Test means the Fire-resistance Test of Elements of Building Construction as described in AS 1530.4.

Structural adequacy, in relation to an FRL, means the ability to maintain stability and adequate *loadbearing* capacity under AS 1530.4.

Structural member means a component or part of an assembly which provides vertical or lateral support to a building or structure.

Surface water means all naturally occurring water, other than sub-surface water, which results from rainfall on or around the *site* or water flowing onto the *site*.

Swimming pool means any excavation or structure containing water and principally used, or designed, manufactured or adapted to be principally used for swimming, wading, paddling, or the like, including a bathing or wading pool, or spa.

Unique wall, for the purposes of **V2.2.1**, means a wall which is neither a *cavity wall* nor a *direct fix cladding wall*.

Verification Method means a test, inspection, calculation or other method that determines whether a *Building Solution* complies with the relevant *Performance Requirements*.

Window includes a roof light, glass panel, glass block or brick, glass louvre, glazed sash, glazed door, or other device which transmits natural light directly from outside a building to the room concerned when in the closed position.

1.1.2 Adoption of referenced documents

Where a *Deemed-to-Satisfy Provision* references a document, rule, specification or provision, that adoption does not include a provision—

- (a) specifying or defining the respective rights, responsibilities or obligations as between themselves of any manufacturer, supplier or purchaser; or
- (b) specifying the responsibilities of any trades person or other building operative, architect, engineer, authority, or other person or body; or
- (c) requiring the submission for approval of any material, building component, form or method of construction, to any person, authority or body other than a person or body empowered under State or Territory legislation to give that approval; or
- (d) specifying that a material, building component, form or method of construction must be submitted to any person, authority or body for expression of opinion; or
- (e) permitting a departure from the code, rule, specification or provision at the sole discretion of the manufacturer or purchaser, or by arrangement or agreement between the manufacturer and purchaser.

1.1.3 Context of reference

- (a) A reference in a *Deemed-to-Satisfy Provision* to a document under **1.1.2** refers to the edition or issue, together with any amendment, listed in **Part 1.4** and only so much as is relevant in the context in which the document is quoted.
- (b) Any—

GENERAL REQUIREMENTS

- (i) reference in a document listed in **Part 1.4** (primary document) to another document (secondary reference); and
- (ii) subsequent references to other documents in secondary documents and those other documents,

is a reference to the secondary and other document as they existed at the time of publication of the primary document listed in **Part 1.4**.

- (c) The provisions of **(b)** do not apply if the secondary referenced document is also a primary referenced document, in which case the edition or issue of the primary referenced document applies.
- (d) Where the *Housing Provisions* references a document under **1.1.2** which is subject to publication of a new edition or amendment not listed under **Part 1.4**, the new edition or amendment need not be complied with in order to comply with the *Deemed-to-Satisfy Provisions*.

1.1.4 Differences between referenced documents and the Housing Provisions

The *Housing Provisions* overrule in any difference arising between it and any document referenced as part of the acceptable construction practice.

1.1.5 Application of the Housing Provisions to a particular State or Territory

For application within a particular State or Territory, the *Housing Provisions* comprise—

- (a) Sections 1 to 3 (inclusive); and
- (b) the variations and deletions applicable to that State or Territory specified in Sections 1 to 3 inclusive; and
- (c) the additions to Sections 1 to 3 inclusive applicable to that State or Territory specified in the relevant Appendix.

1.1.6 Language

- (a) A reference to a building in the *Housing Provisions* is a reference to an entire building or part of a building, as the case requires.
- (b) A reference in a *Performance Requirement* of the *Housing Provisions* to “the degree necessary” means that consideration of all the criteria referred to in the *Performance Requirement* will determine the outcome appropriate to the circumstances. These words have been inserted to indicate that in certain situations it may not be necessary to incorporate any specific measures to meet the *Performance Requirement*.
- (c) A reference to a Class 1a, 1b, 10a, 10b and 10c is a reference to the separate classification.
- (d) A reference to—
 - (i) Class 1 — is a reference to a Class 1a and 1b; and
 - (ii) Class 10 — is a reference to a Class 10a, 10b and 10c.

GENERAL REQUIREMENTS

1.1.7 Interpretation of diagrams

Diagrams in the *Housing Provisions* are used to describe specific issues referenced in the associated text. They are not to be construed as containing all design information that is *required* for that particular building element or situation.

Explanatory information:

Diagrams are used to explain the requirements of a particular clause. To ensure the context of the requirement is clearly understood, adjacent construction elements of the building that would normally be required in that particular situation are not always shown.

Accordingly, aspects of a diagram that are not shown should not be interpreted as meaning these construction details are not *required*.

1.1.8 Explanatory information

- (a) These elements of the *Housing Provisions* are non-mandatory. They are used to provide additional guidance on the application of the particular Parts and clauses and do not need to be followed to meet the requirements of the *Housing Provisions*.
- (b) The ABCB gives no warranty or guarantee that the Explanatory Information is correct or complete. The ABCB shall not be liable for any loss howsoever caused whether due to negligence or otherwise arising from the use of or reliance on the Explanatory Information.
- (c) The ABCB recommends that anyone seeking to rely on the Explanatory Information obtain their own independent expert advice in relation to building or related activities.

PART 1.2

ACCEPTANCE OF DESIGN AND CONSTRUCTION

1.2.1 Suitability of materials

Every part of a building must be constructed in an appropriate manner to achieve the requirements of the *Housing Provisions*, using materials that are fit for the purpose for which they are intended.

1.2.2 Evidence of suitability

- (a) Subject to 1.2.3 and 1.2.4, evidence to support that the use of a material, form of construction or design meets a *Performance Requirement* or a *Deemed-to-Satisfy Provision* may be in the form of one or a combination of the following:
 - (i) A report issued by a *Registered Testing Authority*, showing that the material or form of construction has been submitted to the tests listed in the report, and setting out the results of those tests and any other relevant information that demonstrates its suitability for use in the building.
 - (ii) A current *Certificate of Conformity* or a current *Certificate of Accreditation*.
 - (iii) A certificate from a *professional engineer* or other appropriately qualified person which—
 - (A) certifies that a material, design or form of construction complies with the requirements of the *Housing Provisions*; and
 - (B) sets out the basis on which it is given and the extent to which relevant specifications, rules, codes of practice or other publications have been relied upon.
 - (iv) A current certificate issued by a product certification body that has been accredited by the Joint Accreditation Scheme of Australia and New Zealand (JAS-ANZ).
 - (v) * * * * *
 - (vi) Any other form of documentary evidence that correctly describes the properties and performance of the material or form of construction and adequately demonstrates its suitability for use in the building.
- (b) Evidence to support that a calculation method complies with an ABCB protocol may be in the form of one or a combination of the following:
 - (i) A certificate from a *professional engineer* or other appropriately qualified person which—
 - (A) certifies that the calculation method complies with a relevant ABCB protocol; and
 - (B) sets out the basis on which it is given and the extent to which relevant specifications, rules, codes of practice and other publications have been relied upon.
 - (ii) Any other form of documentary evidence that correctly describes how the calculation method complies with a relevant ABCB protocol.

GENERAL REQUIREMENTS

- (c) Any copy of documentary evidence submitted, must be a complete copy of the original report or document.

1.2.3 Fire resistance of building elements

Where a *Deemed-to-Satisfy Provision* requires a building element to have an FRL, it must comply with the acceptable construction method or be determined in accordance with **Specification A2.3** of BCA Volume One.

1.2.4 Fire hazard properties

Where a *Deemed-to-Satisfy Provision* requires a building component or assembly to have a fire hazard property index, it must be determined in accordance with **Specification A2.4** of BCA Volume One.

Explanatory information:

The provisions of **Part 1.2** list acceptable methods to enable verification and acceptance of both the *Performance Requirements* (listed in **Section 2**) and *Deemed-to-Satisfy Provisions* (listed in **Section 3**) of the *Housing Provisions*.

PART 1.3 CLASSIFICATION

1.3.1 Principles of classification

The classification of a building or part of a building is determined by the purpose for which it is designed, constructed or adapted to be used.

Explanatory information:

1. Class 1 and 10 buildings are classified in accordance with this Part; and
2. Class 2 to 9 buildings are classified in accordance with **Section A** of BCA, Volume One.
3. Access requirements for people with a disability for certain Class 1b and Class 10a buildings, and certain Class 10b *swimming pools*, are contained in Volume One of the BCA. These requirements are based on the Disability (Access to Premises – Buildings) Standards which are available from the Australian Government Attorney-General's Department website at www.ag.gov.au.

1.3.2 Classification

Class 1 and 10 buildings are classified as follows:

Class 1 — one or more buildings, which in association constitute—

- (a) **Class 1a** — a single dwelling being—
 - (i) a detached house; or
 - (ii) one of a group of two or more attached dwellings, each being a building, separated by a *fire-resisting* wall, including a row house, terrace house, town house or villa unit; or
- (b) **Class 1b** —
 - (i) a boarding house, guest house, hostel or the like—
 - (A) with a total area of all floors not exceeding 300 m² measured over the enclosing walls of the Class 1b building; and
 - (B) in which not more than 12 persons would ordinarily be resident; or
 - (ii) 4 or more single dwellings located on one allotment and used for short-term holiday accommodation,

which are not located above or below another dwelling or another Class of building other than a *private garage* (see **Figure 1.3.1**, **1.3.2** and **1.3.3**).

Explanatory information:

Class 1b buildings used for short-term holiday accommodation include cabins in caravan parks, tourist parks, farm stay, holiday resorts and similar tourist accommodation. This accommodation itself is typically rented out on a commercial basis for short periods and generally does not require the signing of a lease agreement. Short-term accommodation can also be provided in a boarding house, guest house, hostel, bed and breakfast accommodation or the like.

Class 10 — a non-habitable building or structure being—

GENERAL REQUIREMENTS

- (a) **Class 10a** — a non-habitable building being a *private garage*, carport, shed, or the like; or
- (b) **Class 10b** — a structure being a fence, mast, antenna, retaining or free-standing wall, *swimming pool*, or the like; or
- (c) **Class 10c** — a *private bushfire shelter*.

(see [Figure 1.3.3](#)).

Figure 1.3.1

IDENTIFICATION OF CLASS 1 BUILDINGS

Note: For *fire-resisting* construction between Class 1 buildings see Part 3.7.1.

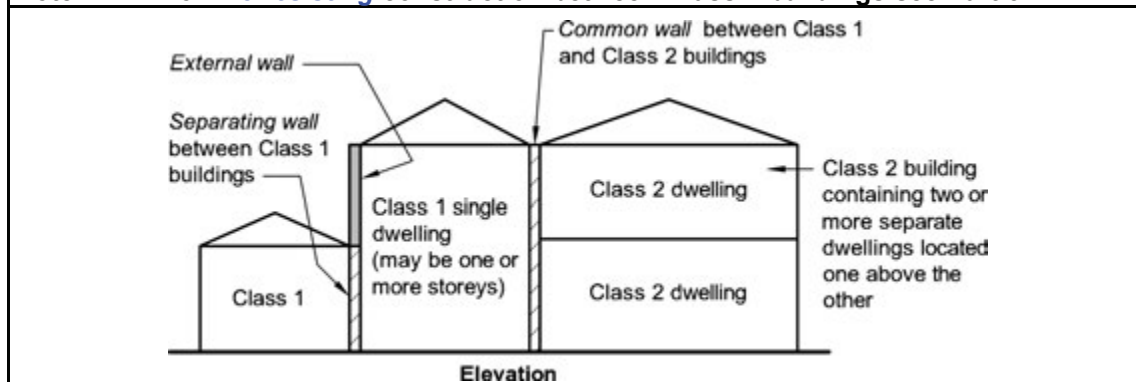
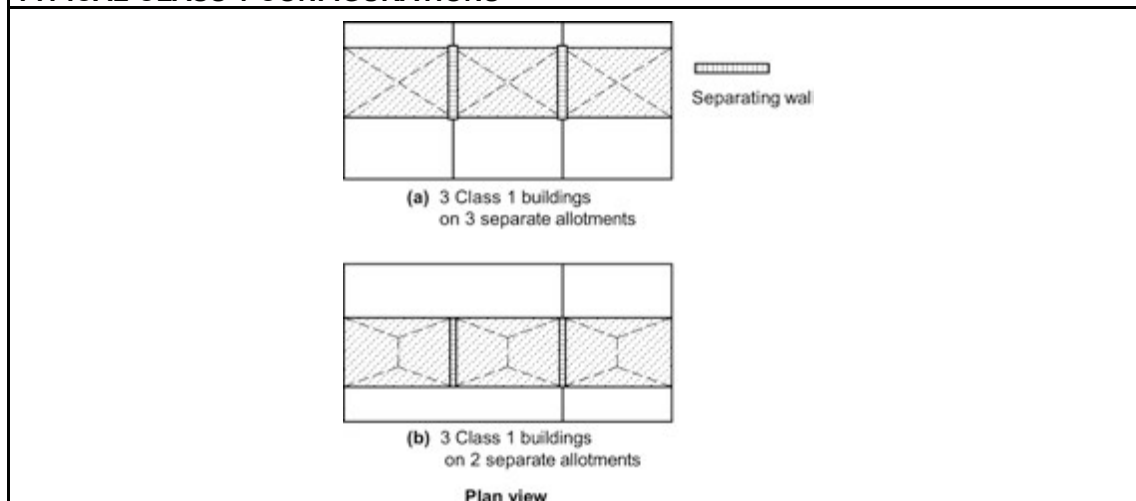

Figure 1.3.2

TYPICAL CLASS 1 CONFIGURATIONS



GENERAL REQUIREMENTS

Figure 1.3.3

DOMESTIC ALLOTMENT — CLASSIFICATION OF BUILDINGS AND STRUCTURES

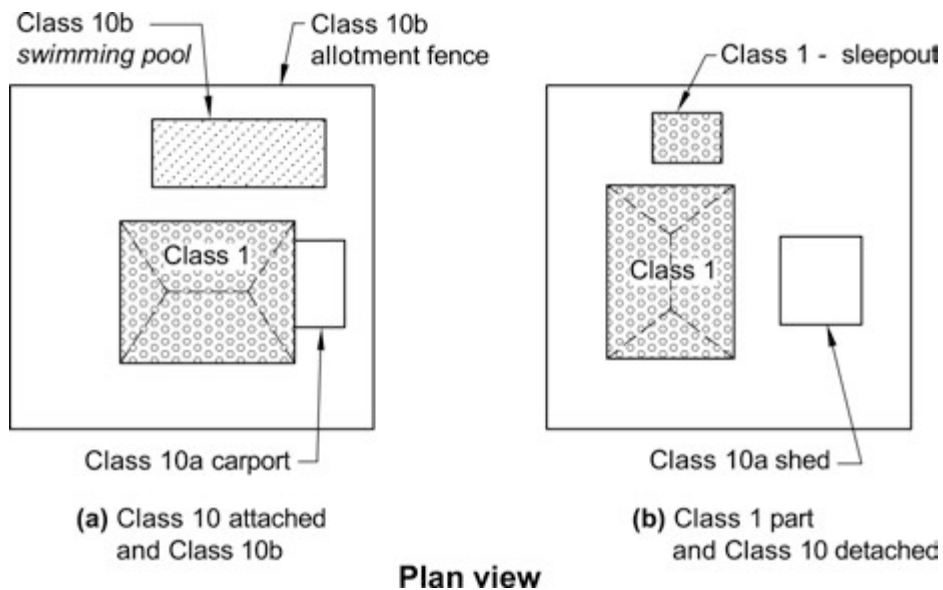

Notes:

1. A Class 10 building may be attached to a Class 1 building.
2. A Class 1 may consist of one or more buildings (eg detached bedrooms).

1.3.3 Multiple classifications

Each part of a building must be classified separately, and—

- (a) Classes 1a, 1b, 10a, 10b and 10c are separate classifications; and
- (b) a reference to—
 - (i) Class 1 — is to Class 1a and 1b; and
 - (ii) Class 10 — is to Class 10a, 10b and 10c; and
- (c) where parts have different purposes — if not more than 10% of the *floor area* of a Class 1 building is used for a purpose which is a different classification, the classification of Class 1 may apply to the whole building.

GENERAL REQUIREMENTS

PART 1.4 DOCUMENTS ADOPTED BY REFERENCE

1.4.1 Schedule of referenced documents

The documents listed in [Table 1.4.1](#) are referred to in the *Housing Provisions*.

Table 1.4.1: SCHEDULE OF REFERENCED DOCUMENTS

No.	Date	Title	BCA Clause(s)
AS/NZS 1170		Structural design actions	
Part 0	2002	General principles Amdt 1 Amdt 3 Amdt 4	3.10.1.0, 3.11.2
Part 1	2002	Permanent, imposed and other actions Amdt 1 Amdt 2	3.9.2.3, 3.11.3
Part 2	2011	Wind actions Amdt 1 Amdt 2 Amdt 3	1.1.1, V2.2.1, 3.10.1.0, 3.11.3
Part 3	2003	Snow and ice actions Amdt 1	3.11.3
AS 1170		Structural design actions	
Part 4	2007	Earthquake actions in Australia	3.4.4.1, 3.10.2.0, 3.11.3
AS/NZS 1200	2000	Pressure equipment	3.7.3.0
AS 1273	1991	Unplasticized PVC (UPVC) downpipe and fittings for rainwater	3.5.2.2

GENERAL REQUIREMENTS

Table 1.4.1: SCHEDULE OF REFERENCED DOCUMENTS — continued

No.	Date	Title	BCA Clause(s)
AS/NZS 1276 Part 1	1999	Acoustics—Rating of sound installation in buildings and of building elements Airborne sound insulation [Note: Test reports based on AS 1276 — 1979 and issued prior to AS/NZS 1276.1 — 1999 being referenced in the BCA, remain valid. The STC values in reports based on AS 1276 — 1979 shall be considered to be equivalent to R_w values. Test reports prepared after the BCA reference date for AS/NZS 1276.1 — 1999 must be based on that version.]	V2.4.6, 3.8.6.2
AS 1288	2006	Glass in buildings—Selection and Installation Amdt 1 Amdt 2	3.6.0, 3.6.1, 3.6.3, 3.9.2.3, 3.10.1.0, 3.11.6
AS 1289 Method 6.3.3	1997	Methods of testing soils for engineering purposes Determination of the penetration resistance of a soil — Perth sand penetrometer test Amdt 1	3.2.2.2
AS 1397	2011	Continuous hot dip metallic coated sheet steel and strip - coatings of zinc and zinc alloyed with aluminium and magnesium Amdt 1	3.4.2.2, 3.5.1.3

GENERAL REQUIREMENTS

Table 1.4.1: SCHEDULE OF REFERENCED DOCUMENTS — continued

No.	Date	Title	BCA Clause(s)
AS 1530		Methods for fire tests on building materials, components and structures	
Part 1	1994	Combustibility test for materials	1.1.1
Part 2	1993	Test for flammability of materials Amdt 1	1.1.1
Part 4	2005	Fire-resistance test of elements of construction [Note: Subject to the note to AS 4072.1, reports relating to tests carried out under earlier editions of AS 1530 Parts 1 to 4 remain valid. Reports relating to tests carried out after the date of an amendment to a Standard must relate to the amended Standard]	1.1.1, 3.7.1.8
AS/NZS 1530		Methods for fire tests on building materials, components and structures	
Part 3	1999	Simultaneous determination of ignitability, flame propagation, heat release and smoke release	1.1.1
AS 1562		Design and installation of sheet roof and wall cladding	
Part 1	1992	Metal Amdt 1 Amdt 2 Amdt 3	3.5.1.0, 3.5.3.0
AS/NZS 1562		Design and installation of sheet roof and wall cladding	
Part 2	1999	Corrugated fibre-reinforced cement	3.5.1.0
Part 3	1996	Plastics	3.5.1.0
AS 1657	2013	Fixed platforms, walkways, stairways and ladders — Design, construction and installation	3.9.1.2
AS/NZS 1664		Aluminium structures	
Part 1	1997	Limit state design Amdt 1	3.11.6
Part 2	1997	Allowable stress design Amdt 1	3.11.6

GENERAL REQUIREMENTS

Table 1.4.1: SCHEDULE OF REFERENCED DOCUMENTS — continued

No.	Date	Title	BCA Clause(s)
AS 1668		The use of ventilation and airconditioning in buildings	
Part 2	2012	Mechanical ventilation in buildings Amdt 1	3.8.5.0
AS/NZS 1680		Interior lighting	
Part 0	2009	Safe movement	3.8.4.3
AS 1684		Residential timber-framed construction	
Part 2	2010	Non-cyclonic areas Amdt 1 Amdt 2	3.2.5.6, 3.4.0.2, 3.4.1.2, 3.4.3.0, 3.10.1.0
Part 3	2010	Cyclonic areas Amdt 1	3.2.5.6, 3.4.0.2, 3.4.1.2, 3.10.1.0
Part 4	2010	Simplified — Non-cyclonic areas Amdt 1	3.2.5.6, 3.4.0.2, 3.4.1.2, 3.4.3.0
AS 1720		Timber structures	
Part 1	2010	Design methods Amdt 1 Amdt 2	3.11.6
AS/NZS 1859		Reconstituted wood-based panels — Specifications	
Part 4	2004	Wet-processed fibreboard	3.5.3.3, 3.5.3.4
AS 1926		Swimming pool safety	
Part 1	2012	Safety barriers for swimming pools	3.9.3.0
Part 2	2007	Location of safety barriers for swimming pools Amdt 1 Amdt 2	3.9.3.0
Part 3	2010	Water recirculation systems Amdt 1	3.9.4.0
AS 2047	2014	Windows and external doors in buildings	V2.2.1, 3.6.0, 3.6.1, 3.10.1.0, 3.11.6, 3.12.3.3
AS 2049	2002	Roof tiles Amdt 1	3.5.1.0, 3.5.1.2

GENERAL REQUIREMENTS

Table 1.4.1: SCHEDULE OF REFERENCED DOCUMENTS — continued

No.	Date	Title	BCA Clause(s)
AS 2050	2002	Installation of roof tiles Amdt 1 Amdt 2	3.5.1.0, 3.5.1.2
AS 2159	2009	Piling — Design and installation Amdt 1	3.2.0, 3.11.6
AS/NZS 2179 Part 1	2014	Specification for rainwater goods, accessories and fasteners Metal shape or sheet rainwater goods and metal accessories and fasteners	3.5.2.2
AS/NZS 2269 Part 0	2012	Plywood — Structural Specifications	3.5.3.4
AS 2327 Part 1	2003	Composite structures Simply supported beams	3.11.6
AS 2870	2011	Residential slabs and footings	3.1.2.4, 3.1.3.2, 3.1.3.7, 3.2.0, 3.2.1, 3.2.2.4, 3.2.2.6, 3.2.3.2, 3.2.4.1, 3.2.5, 3.2.5.2, 3.2.5.6, 3.11.6
AS/NZS 2904	1995	Damp-proof courses and flashings Amdt 1 Amdt 2	3.5.3.6
AS/NZS 2908 Part 2	2000	Cellulose cement products Flat sheets	3.5.3.3, 3.5.3.4, 3.5.3.5,
AS/NZS 2918	2001	Domestic solid fuel burning appliances — Installation	3.7.3.0, 3.7.3.4, 3.7.3.5
AS/NZS 3500 Part 3	2003	Plumbing and drainage Stormwater drainage Amdt 1 Amdt 2 Amdt 3	3.1.2.0, 3.1.2.4, 3.5.2.0, 3.5.2.5
Part 5	2012	Housing installations	3.1.2.0, 3.1.2.4, 3.5.2.0, 3.5.2.5
AS 3600	2009	Concrete structures Amdt 1 Amdt 2	3.2.2.4, 3.2.3.1, 3.2.5.6, 3.11.6

GENERAL REQUIREMENTS

Table 1.4.1: SCHEDULE OF REFERENCED DOCUMENTS — continued

No.	Date	Title	BCA Clause(s)
AS 3660		Termite management	
Part 1	2000	New building work	3.1.3, 3.1.3.0, , 3.1.3.4, 3.1.3.5, 3.1.3.6
		[Note: The 2000 edition has been retained for a transitional period ending on 30 April 2017]	
Part 1	2014	New building work	3.1.3, 3.1.3.0, 3.1.3.4, 3.1.3.5, 3.1.3.6
Part 3	2014	Assessment criteria for termite management systems	3.1.3.6
AS 3700	2011	Masonry structures	3.3.1.0, 3.3.2.0, 3.3.3.0, 3.3.4.0, 3.10.1.0, 3.11.6
		Amdt 1	
AS 3740	2010	Waterproofing of domestic wet areas	3.8.1.2
		Amdt 1	
AS 3786	2014	Smoke alarms	3.7.2.2
AS 3786	1993	Smoke alarms	3.7.2.2
		Amdt 1	
		Amdt 2	
		Amdt 4	
		[Note: The 1993 edition has been retained for a transitional period ending on 30 April 2017]	
AS 3959	2009	Construction of buildings in bushfire-prone areas	3.7.4.0
		Amdt 1	
		Amdt 2	
		Amdt 3	

GENERAL REQUIREMENTS

Table 1.4.1: SCHEDULE OF REFERENCED DOCUMENTS — continued

No.	Date	Title	BCA Clause(s)
AS 4055	2012	Wind loads for housing	1.1.1, 3.11.3
AS 4072		Components for the protection of openings in fire-resistant separating elements	
Part 1	2005	Service penetrations and control joints Amdt 1 [Note: Systems tested to AS 1530.4 prior to 1 January 1995 need not be retested to comply with the provisions in AS 4072.1]	3.7.1.8
AS 4100	1998	Steel structures Amdt 1	3.2.5.6, 3.4.2.0, 3.4.4.0, 3.10.1.0, 3.11.6
AS/NZS 4200		Pliable building membranes and underlays	
Part 1	1994	Materials Amdt 1	3.5.1.0
Part 2	1994	Installation requirements	3.5.1.0
AS 4254		Ductwork for air-handling systems in buildings	
Part 1	2012	Flexible duct	3.7.1.9, 3.12.5.3
Part 2	2012	Rigid duct	3.7.1.9, 3.12.5.3
AS/NZS 4256		Plastic roof and wall cladding material	
Part 1	1994	General requirements	3.5.1.0
Part 2	1994	Unplasticized polyvinyl chloride (UPVC) building sheets	3.5.1.0
Part 3	1994	Glass fibre reinforced polyester (GRP)	3.5.1.0
Part 5	1996	Polycarbonate	3.5.1.0
AS/NZS 4284	2008	Testing of building facades	V2.2.1
AS/NZS 4505	2012	Garage doors and other large access doors	3.11.6

GENERAL REQUIREMENTS

Table 1.4.1: SCHEDULE OF REFERENCED DOCUMENTS — continued

No.	Date	Title	BCA Clause(s)
AS 4586	2013	Slip resistance classification of new pedestrian surface materials [Note: Test reports based on the 2004 edition of AS/NZS 4586 and issued prior to the 2013 edition of AS 4586 being referenced in the BCA remain valid. Test reports prepared after the BCA reference date of the 2013 edition of AS 4586 must be based on that version. For the purposes of assessing compliance, the slip-resistance classifications of V, W and X in reports based on the 2004 edition of AS/NZS 4586 may be considered to be equivalent to slip-resistance classifications of P5, P4 and P3 respectively in the 2013 edition of AS 4586.]	3.9.1.3
AS/NZS 4600	2005	Cold-formed steel structures Amdt 1	3.4.2.0, 3.4.2.1, 3.4.4.0, 3.10.1.0, 3.11.6
AS 4654		Waterproofing membranes for external above-ground use	
Part 1	2012	Materials	3.8.1.3
Part 2	2012	Design and Installation	3.8.1.3
AS 4773		Masonry for small buildings	
Part 1	2010	Design Amdt 1	3.3.1.0, 3.3.2.0, 3.3.3.0, 3.3.4.0, 3.10.1.0, 3.11.6
Part 2	2010	Construction	3.3.1.0, 3.3.2.0, 3.3.3.0, 3.3.4.0, 3.10.1.0, 3.11.6
AS/NZS 4859		Materials for the thermal insulation of buildings	
Part 1	2002	General criteria and technical provisions Amdt 1	3.12.1.1, 3.12.1.5, 3.12.5.1
ASTM D3018-90	1994	Class A asphalt shingles surfaced with mineral granules	3.5.1.0
ABC B	2011	Protocol for Structural Software, Version 2011.1	3.4.0.2

GENERAL REQUIREMENTS

Table 1.4.1: SCHEDULE OF REFERENCED DOCUMENTS — continued

No.	Date	Title	BCA Clause(s)
ABCB	2012	Standard for Construction of Buildings in Flood Hazard Areas, Version 2012.2	3.10.3.0
ISO 717		Acoustics — Rating of sound insulation in buildings and of building elements	
Part 1	1996	Airborne sound insulation	V2.4.6, 3.8.6.2
ISO 8336	1993E	Fibre cement flat sheets	3.5.3.3, 3.5.3.4, 3.5.3.5
NASH Standard	2014	Steel Framed Construction in Bushfire Areas	3.7.4.0
NASH Standard		Residential and Low-Rise Steel Framing	
Part 1	2005	Design Criteria	3.4.2.0, 3.4.2.1, 3.10.1.0, 3.11.6
		Amdt A	
		Amdt B	
		Amdt C	
Part 2	2014	Design Solutions	3.4.2.0, 3.4.2.1, 3.10.1.0
Northern Territory Deemed to comply Standards manual			3.10.1.0
TN 61		Cement Concrete and Aggregates Australia — Articulated walling	3.2.1

STATE AND TERRITORY VARIATIONS SCHEDULE OF REFERENCED DOCUMENTS

AUSTRALIAN CAPITAL TERRITORY REFERENCED DOCUMENTS			
No.	Date	Title	
	2014	Development Control Code for Best Practice Waste Management in the ACT	ACT 3.2
ISO 10077-1	2006	Thermal performance of windows, doors and shutters — Calculation of thermal transmittance	ACT 7.1.4(a)(ii)
NEW SOUTH WALES REFERENCED DOCUMENTS			
AS 1603		Automatic fire detection and alarm systems	
Part 3	1996	Heat alarms	NSW 1.1.4
NSW Legislation	1979	Environmental Planning and Assessment Act	3.7.4.0, NSW P2.6.1, NSW 3.12.1
NSW Legislation	1997	Rural Fires Act	3.7.4.0

GENERAL REQUIREMENTS

NSW Legislation	1992	Swimming Pools Act	O2.5, F2.5.2, P2.5.3, 3.9.3
NSW Legislation	2008	Swimming Pools Regulation	O2.5, F2.5.2, P2.5.3, 3.9.3
NORTHERN TERRITORY REFERENCED DOCUMENTS			
BCA 2009	May 2009	Building Code of Australia	2.6, 3.12
QUEENSLAND REFERENCED DOCUMENTS			
Queensland Government, Department of Agriculture, Fisheries and Forestry - Construction timbers in Queensland, Book 1 and Book 2: Properties and specifications for satisfactory performance of construction timbers in Queensland - Class 1 and 10 buildings (Houses, carports, garages, greenhouses and sheds)			3.4.3.0
Building Act 1975			O2.5, F2.5.2, P2.5.3, 3.9.3
SOUTH AUSTRALIAN REFERENCED DOCUMENTS			
SA 3.12.0.1(a)	2012	South Australian Minister's Specification — Heating and cooling loads for elevated buildings with a lightweight framed flooring system and transportable buildings	SA 3.12.0.1(a)
AS 1428		Design for access and mobility	
Part 1	2001	General requirements for access — New building work	SA 5.2.3
AS 1530.8		Tests on elements of construction for buildings exposed to simulated bushfire attack	
Part 1	2007	Radiant heat and small flaming sources	SA 3.7.4.3
Part 2	2007	Large flaming sources	SA 3.7.4.3
enHealth Council, Department of Health and Ageing	2004	Guidance on the use of rainwater tanks	SA 2.2.4
VICTORIAN REFERENCED DOCUMENTS			
	2008	Plumbing Regulations	V2.6.1, 3.12.0
WESTERN AUSTRALIAN REFERENCED DOCUMENTS			
AS/NZS 3500.4	2003	Plumbing and drainage - Heated water services, Amdt 1	WA 2.3.3

PERFORMANCE PROVISIONS

- 2.0 Application**
- 2.1 Structure**
- 2.2 Damp and Weatherproofing**
- 2.3 Fire safety**
- 2.4 Health and amenity**
- 2.5 Safe movement and access**
- 2.6 Energy Efficiency**

SECTION 2 CONTENTS

SECTION 2 PERFORMANCE PROVISIONS

2.0 Application

2.0 Application

2.1 Structure

P2.1.1 Structural stability and resistance to actions
P2.1.2 Construction of buildings in flood hazard areas
V2.1.1 Structural reliability

2.2 Damp and Weatherproofing

P2.2.1 Surface water
P2.2.2 Weatherproofing
P2.2.3 Dampness
P2.2.4 Drainage from swimming pools
V2.2.1 Weatherproofing

2.3 Fire Safety

P2.3.1 Protection from the spread of fire
P2.3.2 Fire detection and early warning
P2.3.3 Heating appliances
P2.3.4 Bushfire areas
P2.3.5 Private bushfire shelters
P2.3.6 Alpine areas

2.4 Health and Amenity

P2.4.1 Wet areas
P2.4.2 Room heights
P2.4.3 Facilities
P2.4.4 Light
P2.4.5 Ventilation
P2.4.6 Sound insulation
V2.4.6 Sound insulation

2.5 Safe Movement and Access

P2.5.1 Stairways and ramps
P2.5.2 Barriers
P2.5.3 Swimming pool access
P2.5.4 Swimming pool water recirculation systems
V2.5.1 Wire barriers

2.6 Energy Efficiency

P2.6.1 Building

P2.6.2 Services

V2.6 Definitions

V2.6.1 Application of this Part

V2.6.2 * * * * *

V2.6.2.1 * * * * *

V2.6.2.2 Verification using a reference building

V2.6.3 * * * * *

PART 2.0 APPLICATION

2.0 Application

- (a) This Section contains the *Objectives*, *Functional Statements* and *Performance Requirements* for Class 1 and 10 buildings (other than access requirements for people with disabilities in Class 10 buildings).
- (b) For the purposes of this Section a reference to a building includes a reference to both Class 1 and 10 buildings unless otherwise specified.

Note:

Access requirements for people with disabilities in Class 10 buildings are contained in **Part D3** of the BCA Volume One.

PART 2.1 STRUCTURE

OBJECTIVE

O2.1

The *Objective* is to—

- (a) safeguard people from injury caused by structural failure; and
- (b) safeguard people from loss of amenity caused by structural behaviour; and
- (c) protect *other property* from physical damage caused by structural failure; and
- (d) safeguard people from injury that may be caused by failure of, or impact with, glazing.

FUNCTIONAL STATEMENTS

F2.1

- (a) A building or structure is to withstand the combination of loads and other actions to which it may be reasonably subjected.
- (b) Glazing is to be installed in a building to avoid undue risk of injury to people.

PERFORMANCE REQUIREMENTS

P2.1.1 Structural stability and resistance to actions

- (a) A building or structure, during construction and use, with appropriate degrees of reliability, must—
 - (i) perform adequately under all reasonably expected design actions; and
 - (ii) withstand extreme or frequently repeated design actions; and
 - (iii) be designed to sustain local damage, with the structural system as a whole remaining stable and not being damaged to an extent disproportionate to the original local damage; and
 - (iv) avoid causing damage to *other properties*,
by resisting the actions to which it may reasonably be expected to be subjected.
- (b) The actions to be considered to satisfy (a) include but are not limited to—
 - (i) permanent actions (dead loads); and
 - (ii) imposed actions (live loads arising from occupancy and use); and

PERFORMANCE PROVISIONS

- (iii) wind action; and
 - (iv) earthquake action; and
 - (v) snow action; and
 - (vi) liquid pressure action; and
 - (vii) ground water action; and
 - (viii) rainwater action (including ponding action); and
 - (ix) earth pressure action; and
 - (x) differential movement; and
 - (xi) time dependent effects (including creep and shrinkage); and
 - (xii) thermal effects; and
 - (xiii) ground movement caused by—
 - (A) swelling, shrinkage or freezing of the subsoil; and
 - (B) landslip or subsidence; and
 - (C) siteworks associated with the building or structure; and
 - (xiv) *construction activity actions*; and
 - (xv) termite actions.
- (c) The structural resistance of materials and forms of construction must be determined using five percentile characteristic material properties with appropriate allowance for—
- (i) known construction activities; and
 - (ii) type of material; and
 - (iii) characteristics of the site; and
 - (iv) the degree of accuracy inherent in the methods used to assess the structural behaviour; and
 - (v) action effects arising from the differential settlement of foundations, and from restrained dimensional changes due to temperature, moisture, shrinkage, creep and similar effects.
- (d) Glass installations that are at risk of being subjected to human impact must have glazing that—
- (i) if broken on impact, will break in a way that is not likely to cause injury to people; and
 - (ii) resists a reasonably foreseeable human impact without breaking; and
 - (iii) is protected or marked in a way that will reduce the likelihood of human impact.

P2.1.2 Construction of buildings in flood hazard areas

- (a) A building in a *flood hazard area* must be designed and constructed, to the degree necessary, to resist flotation, collapse or significant permanent movement resulting from the action of hydrostatic, hydrodynamic, erosion and scour, wind and other actions during the *defined flood event*.

PERFORMANCE PROVISIONS

- (b) The actions and requirements to be considered to satisfy (a) include but are not limited to—
- (i) flood actions; and
 - (ii) elevation requirements; and
 - (iii) foundation and footing requirements; and
 - (iv) requirements for enclosures below the *flood hazard level*; and
 - (v) requirements for structural connections; and
 - (vi) material requirements; and
 - (vii) requirements for utilities; and
 - (viii) requirements for occupant egress.

Limitation:

P2.1.2 only applies to a Class 1 building.

STATE AND TERRITORY VARIATIONS

P2.1.2 does not apply in Queensland.

Note: Building work in designated *flood hazard areas* is regulated by the Building Act 1975 and Development Code 3.5 - Construction of buildings in flood hazard areas.

In Queensland after P2.1.2 insert QLD P2.1.3 as follows:

QLD P2.1.3

- (a) The risk of *primary building elements* in a Class 1 or 10 building being damaged by subterranean termites must be adequately minimised by the use of a suitable termite management measure that—
- (i) if it serves a non-temporary Class 1 building, has a design life of at least 50 years; or
 - (ii) if it serves a building not specified in (i), has a design life of at least 50 years or the specified design life of the building, whichever is the lesser; or
 - (iii) is easily and readily accessible for replenishment or replacement and is capable of being replenished or replaced.
- (b) A termite management measure required by (a), to the degree necessary, must—
- (i) be accessible to enable the installation, maintenance and inspection of the termite management measure to be carried out; and
 - (ii) incorporate suitable measures to adequately minimise the risk of the termite management measure inadvertently being damaged, bridged or breached.

PERFORMANCE PROVISIONS

Explanatory information:

QLD P2.1.3(a) requires a termite management measure in Queensland to have a design life of at least 50 years unless it is easily and readily accessible for replenishment or replacement and is capable of being replenished or replaced. In recognition that some buildings other than non-temporary Class 1 buildings may be designed to last less than 50 years, the option of the termite management measure having a design life at least equal to that specified for the building is given. If this option is used, the design life of the building should be agreed upon by all relevant stakeholders at the design stage and should form part of the documentation kept by the *appropriate authority*. It should not be assumed that the design life of 50 years in **QLD P2.1.3(a)(i)** and **(ii)** applies to any other provisions of the BCA, unless stated.

An example of a termite management measure that may satisfy **QLD P2.1.3(a)(iii)** is a chemical reticulation system beneath a concrete floor slab laid directly on the ground, provided that the system is easily and readily accessible for replenishment and is capable of being replenished.

An example of a termite management measure that may not satisfy **QLD P2.1.3(a)** for a non-temporary Class 1 building is a hand-sprayed chemical beneath a concrete floor slab laid directly on the ground if the chemical does not have a design life of at least 50 years. The concrete floor slab being laid directly on the ground would prevent the area beneath the slab from being easily and readily accessible for replenishment or replacement of the termite management measure.

An example of a termite management measure being inadvertently bridged or breached is when a person places a garden or mulch over the top of or above the level of a termite management measure enabling termites to bypass the measure.

P2.1.2 does not apply in South Australia.

V2.1.1 Structural reliability

Explanatory information:

V2.1.1 is a means to verify the structural reliability of a structural component or connection in order to meet the requirements of **P2.1.1(a)**, **(b)** and **(c)**. For further guidance, refer to the ABCB Handbook for Structural Reliability.

Compliance with **P2.1.1(a)**, **(b)** and **(c)** is verified for the design of structural components and connections when—

- (a) the calculated annual structural reliability index (β), for each action, is not less than that listed in **Table V2.1.1a**; and

PERFORMANCE PROVISIONS

Table V2.1.1a – ANNUAL STRUCTURAL RELIABILITY INDICES (β) FOR STRUCTURAL COMPONENTS AND CONNECTIONS

Importance Level (see Table V2.1.1a)	Permanent and imposed actions	Wind, earthquake and snow actions
1	3.8	3.2
2		3.4

Note: The structural reliability indices shown in this table are for primary structural components and connections whose failure could result in collapse of the building structure or *other property*. For other structural components and connections, the target structural reliability indices can be reduced by 0.3.

(b) the structural reliability index (β) is calculated in accordance with the following formula:

$$\beta = \ln\left[\left(\frac{R_m}{Q_m}\right) \sqrt{\frac{C_Q}{C_R}}\right] / \sqrt{\ln(C_R \cdot C_Q)}$$

where—

$$\left(\frac{R_m}{Q_m}\right) = \left(\frac{\gamma}{\Phi}\right) \left(\frac{R_m}{R_n}\right) / \left(\frac{Q_m}{Q_n}\right)$$

$$C_R = 1 + V_R^2$$

$$C_Q = 1 + V_Q^2$$

C_Q = correction factor for action; and

C_R = correction factor for resistance; and

Q_m = mean action; and

Q_n = nominal design action; and

R_m = mean resistance; and

R_n = nominal design resistance; and

V_Q = coefficient of variation with respect to action; and

V_R = coefficient of variation with respect to resistance; and

Φ = capacity factor; and

γ = load factor; and

PERFORMANCE PROVISIONS

- (c) the action models for calculation of the annual structural reliability index are determined in accordance with [Table V2.1.1b](#); and
- (d) the resistance model for the structural component or connection is established after taking into account variability due to material properties, fabrication and construction processes, and structural modelling.

Table V2.1.1b – ACTION MODELS

Importance Level	Permanent action		Imposed action		Wind action				Snow action		Earthquake action	
	Q _m	V _Q	Q _m	V _Q	Non-cyclonic		Cyclonic		Q _m	V _Q	Q _m	V _Q
					Q _m	V _Q	Q _m	V _Q				
1	1.00	0.10	0.50	0.43	0.41	0.52	0.21	0.79	0.32	0.57	0.072	1.97
2	1.00	0.10	0.50	0.43	0.34	0.52	0.18	0.79	0.30	0.57	0.054	1.97

PART 2.2 DAMP AND WEATHERPROOFING

OBJECTIVE

O2.2

The *Objective* is to—

- (a) safeguard occupants from illness or injury and protect the building from damage caused by—
 - (i) *surface water*; and
 - (ii) external moisture entering a building; and
 - (iii) the accumulation of internal moisture in a building; and
 - (iv) discharge of *swimming pool* waste water; and
- (b) protect *other property* from damage caused by—
 - (i) redirected *surface water*; and
 - (ii) the discharge of *swimming pool* waste water.

STATE AND TERRITORY VARIATIONS

O2.2(a)(iv) and O2.2(b)(ii) do not apply in the Northern Territory.

FUNCTIONAL STATEMENTS

F2.2.1 Surface water

A building including any associated *sitework* is to be constructed in a way that protects people and *other property* from the adverse effects of redirected *surface water*.

F2.2.2 Weatherproofing and dampness

A building is to be constructed to provide resistance to moisture from the outside and moisture rising from the ground.

Limitation:

F2.2.2 does not apply to a Class 10 building except where its construction contributes to the weatherproofing of the Class 1 building.

PERFORMANCE PROVISIONS

F2.2.3 Drainage from swimming pools

Adequate means for the disposal of *swimming pool* water and drainage is to be provided to a *swimming pool*.

STATE AND TERRITORY VARIATIONS

F2.2.3 does not apply in the Northern Territory.

PERFORMANCE REQUIREMENTS

P2.2.1 Surface water

- (a) *Surface water*, resulting from a storm having an *average recurrence interval* of 20 years and which is collected or concentrated by a building or *sitework*, must be disposed of in a way that avoids the likelihood of damage or nuisance to any *other property*.
- (b) *Surface water*, resulting from a storm having an *average recurrence interval* of 100 years must not enter the building.

Limitation:

P2.2.1(b) does not apply to a Class 10 building where in the particular case there is no necessity for compliance.

- (c) A drainage system for the disposal of *surface water* resulting from a storm having an *average recurrence interval* of—
 - (i) 20 years must—
 - (A) convey *surface water* to an appropriate *outfall*; and
 - (B) avoid *surface water* damaging the building; and
 - (ii) 100 years must avoid the entry of *surface water* into a building.

P2.2.2 Weatherproofing

A roof and *external wall* (including openings around *windows* and doors) must prevent the penetration of water that could cause—

- (a) unhealthy or dangerous conditions, or loss of amenity for occupants; and
- (b) undue dampness or deterioration of building elements.

Limitation:

P2.2.2(a) does not apply to a Class 10 building except where its construction contributes to the weatherproofing of the Class 1 building.

P2.2.3 Dampness

Moisture from the ground must be prevented from causing—

- (a) unhealthy or dangerous conditions, or loss of amenity for occupants; and

PERFORMANCE PROVISIONS

- (b) undue dampness or deterioration of building elements.

Limitation:

P2.2.3 does not apply to a Class 10 building where in the particular case there is no necessity for compliance.

STATE AND TERRITORY VARIATIONS

P2.2.3 has been replaced in South Australia as follows:

P2.2.3 Dampness

- (a) Moisture from the ground must be prevented from causing—
- (i) undue dampness or deterioration of building elements; and
 - (ii) unhealthy or dangerous conditions, or loss of amenity for occupants.
- (b) Barriers installed to prevent transfer of moisture from the ground must have—
- (i) high resistance to moisture penetration; and
 - (ii) high resistance to damage during construction; and
 - (iii) high resistance to degradation by dissolved salts.

In New South Wales delete P2.2.3 and insert NSW P2.2.3 as follows:

NSW P2.2.3 Dampness

- (a) Moisture from the ground must be prevented from causing—
- (i) unhealthy or dangerous conditions, or loss of amenity for occupants; and
 - (ii) undue dampness or deterioration of building elements.
- (b) Barriers installed beneath slab on ground construction for the purposes of (a) must have a high resistance to damage during construction.

Limitation:

P2.2.3 does not apply to a Class 10 building where in the particular case there is no necessity for compliance.

Explanatory information:

The intent of requiring the barrier to have a high resistance to damage during construction is to increase the barrier's ability to resist punctures during construction. By being less susceptible to puncturing, the barrier will provide increased protection against moisture containing dissolved salts from coming into contact with the concrete slab.

P2.2.4 Drainage from swimming pools

A *swimming pool* must have adequate means of draining the pool in a manner which will not—

- (a) cause illness to people; or
- (b) affect *other property*.

Note:

The *Housing Provisions* do not contain any *Deemed-to-Satisfy Provisions* for this *Performance Requirement*.

PERFORMANCE PROVISIONS

STATE AND TERRITORY VARIATIONS

P2.2.4 does not apply in the Northern Territory.

VERIFICATION METHODS

V2.2.1 Weatherproofing

- (a) Compliance with **P2.2.2** for the weatherproofing of an *external wall* that—
- (i) has a risk score of 20 or less, when the sum of all risk factor scores are determined in accordance with **Table V2.2.1a**; and
 - (ii) is not subjected to an ultimate limit state wind pressure of more than 2.5 kPa; and
 - (iii) includes only windows that comply with AS 2047,
- is verified when a prototype passes the procedure described below:
- (iv) The test specimen is in accordance with the requirements of **(b)**.
 - (v) The test procedure is in accordance with the requirements of **(c)**.
 - (vi) The test specimen does not fail the criteria in **(d)**.
 - (vii) The test is recorded in accordance with the requirements of **(e)**.

Table V2.2.1a – RISK FACTORS AND SCORES

Risk factor	Category	Risk severity	Score
Wind region	Region A (AS/NZS 1170.2)	Low to medium	0
	Region B (AS/NZS 1170.2)		
	Region C (AS/NZS 1170.2)	High	1
	Region D (AS/NZS 1170.2)	Very high	2
Number of storeys	One storey	Low	0
	Two storeys in part	Medium	1
	Two storeys	High	2
	More than two storeys	Very high	4
Roof/wall junctions	Roof-to-wall junctions fully protected	Low	0
	Roof-to-wall junctions partially exposed	Medium	1
	Roof-to-wall junctions fully exposed	High	3
	Roof elements finishing within the boundaries formed by the <i>external walls</i>	Very high	5

PERFORMANCE PROVISIONS

Table V2.2.1a – RISK FACTORS AND SCORES— continued

Risk factor	Category	Risk severity	Score
Eaves width	Greater than 600 mm for single storey	Low	0
	451-600 mm for single storey; or greater than 600 mm for two storey	Medium	1
	101-450 mm for single storey; or 451-600 mm for two storey; or greater than 600 mm for above two storey	High	2
	0-100 mm for single storey; or 0-450 mm for two storey; or less than 600 mm for above two storey	Very high	5
Envelope complexity	Simple shape with single cladding type	Low	0
	Complex shape with no more than two cladding types	Medium	1
	Complex shape with more than two cladding types	High	3
	As for high risk but with fully exposed roof-to-wall junctions	Very high	6
Decks, porches and balconies	None; or timber slat deck or porch at ground level	Low	0
	Fully covered in plan view by roof; or timber slat deck attached at first or second floor level	Medium	2
	Balcony exposed in plan view at first floor level; or balcony cantilevered at first floor level	High	4
	Balcony exposed in plan view at second floor level or above; or balcony cantilevered at second floor level or above	Very high	6

Notes:

- Eaves width is measured horizontally from the external face of any wall cladding to the outer edge of any overhang, including fascia and external gutters.
- Barriers to prevent falling and parapets are considered as 0 mm eaves.

(b) Test specimen

The test specimen must incorporate—

- representative samples of openings and joints, including—
 - vertical and horizontal control joints; and
 - wall junctions; and

PERFORMANCE PROVISIONS

- (C) *windows* or doors; and
- (D) electrical boxes; and
- (E) balcony drainage and parapet flashings; and
- (F) footer and header termination systems; and
- (ii) for a *cavity wall*—
 - (A) a transparent material for a proportion of the internal wall lining (to provide an unobstructed view of the *external wall* cladding) with sufficient structural capability and similar air tightness to resist the applied wind pressures; and
 - (B) a 15 mm diameter hole in the internal wall lining below a *window*.
- (c) **Test procedure**
 - (i) The test procedure for a *direct fix cladding wall* or *unique wall* must be as follows:
 - (A) Apply 100% positive and negative serviceability wind pressures to the external face of the test specimen for a period of not less than 1 minute each.
 - (B) Apply static pressure of either 300 Pa or 30% serviceability wind pressure, whichever is higher, in accordance with the water penetration test procedure at clause 8.5.2 of AS/NZS 4284.
 - (C) Apply cyclic pressure in accordance with—
 - (aa) the three stages of **Table V2.2.1b**; and
 - (bb) the water penetration test procedure at clause 8.6.2 of AS/NZS 4284.

Table V2.2.1b

Stage number	Serviceability wind pressure
1	15% to 30%
2	20% to 40%
3	30% to 60%

- (ii) The test procedure for a *cavity wall* must be as follows:
 - (A) Apply 100% positive and negative serviceability wind pressures to the external face of the test specimen for a period of not less than 1 minute each.
 - (B) Apply static pressure of either 300 Pa or 30% serviceability wind pressure, whichever is higher, in accordance with the water penetration test procedure at clause 8.5.2 of AS/NZS 4284.
 - (C) Apply cyclic pressure in accordance with—
 - (aa) stage 3 of **Table V2.2.1b**; and
 - (bb) the water penetration test procedure at clause 8.6.2 of AS/NZS 4284.
 - (D) To simulate the failure of the primary weather-defence or sealing, the following procedure must be applied to the test specimen:
 - (aa) Insert 6 mm diameter holes through the external face of the *cavity wall* in all places specified below:
 - (AA) Wall/window or wall/door junctions at $\frac{3}{4}$ height.

PERFORMANCE PROVISIONS

(BB) Immediately above the head flashing.

(CC) Through external sealing of the horizontal and vertical joints.

(DD) Above any other penetration detail not covered by (AA) to (CC).

(bb) Repeat the static and cyclic pressure tests of (B) and (C).

(cc) Within 30 minutes of the completion of (bb), remove the internal lining of the *cavity wall* and check for compliance with (d).

(dd) With the internal lining removed, apply a final static pressure test at 50 Pa for a period of 15 minutes.

(d) Compliance

(i) A *direct fix cladding wall* and *unique wall* are verified for compliance with P2.2.2 if there is no presence of water on the inside surface of the facade.

(ii) A *cavity wall* is verified for compliance with P2.2.2 if there is no presence of water on the removed surface of the cavity, except that during the simulation of the failure of the primary weather-defence or sealing, water may—

(A) transfer to the removed surface of the cavity due to the introduced defects (6 mm holes); and

(B) contact, but not pool on, battens and other cavity surfaces.

(e) Test report

The test report must include the following information:

(i) Name and address of the person supervising the test.

(ii) Test report number.

(iii) Date of the test.

(iv) Cladding manufacturer's name and address.

(v) Construction details of the test specimen, including a description, and drawings and details of the components, showing modifications, if any.

(vi) Test sequence with the pressures used in all tests.

(vii) For each of the static and cyclic pressure tests, full details of all leakages, including position, extent and timing.

Explanatory information:

Verification Method V2.2.1 contains the same test procedures, compliance criteria and reporting of test results that are contained in *Verification Method FV1*, Volume One of the BCA. Consequently, the Guide to Volume One of the BCA contains detailed and supportive explanatory information that is also relevant to V2.2.1.

PART 2.3 FIRE SAFETY

OBJECTIVE

O2.3

The *Objective* is to—

- (a) safeguard the occupants from illness or injury—
 - (i) by alerting them of a fire in the building so that they may safely evacuate; and
 - (ii) caused by fire from heating appliances installed within the building; and
 - (iii) in *alpine areas*, from an emergency while evacuating the building; and
- (b) avoid the spread of fire; and
- (c) protect a building from the effects of a bushfire; and
- (d) reduce the likelihood of fatalities arising from occupants of a Class 1a dwelling not evacuating a property prior to exposure from a bushfire event.

Application:

O2.3(d) only applies to a Class 10c building.

STATE AND TERRITORY VARIATIONS

O2.3 has been replaced in Tasmania as follows:

O2.3

The *Objective* is to—

- (a) safeguard people from illness or injury—
 - (i) by alerting them of a fire in the building so that they may safely evacuate; and
 - (ii) caused by fire and emissions from heating appliances installed within the building; and
 - (iii) in *alpine areas*, from an emergency while evacuating the building; and
- (b) avoid the spread of fire; and
- (c) protect buildings from the effects of a bushfire; and
- (d) assist fire fighting access and occupant evacuation in a bushfire prone area; and
- (e) ensure the availability of water for fire fighting purposes in a bushfire prone area.
- (f) reduce the likelihood of fatalities arising from occupants of a Class 1a dwelling not evacuating a property prior to exposure from a bushfire event.

Application:

O2.3(f) only applies to a Class 10c building.

FUNCTIONAL STATEMENTS

F2.3.1 Protection from the spread of fire

A Class 1 building is to be protected from the spread of fire.

F2.3.2 Fire detection and early warning

A Class 1 building is to be provided with safeguards so that occupants are warned of a fire in the building so that they may safely evacuate.

F2.3.3 Heating appliances

Heating appliances using controlled combustion located in a building are to be installed in a way which reduces the likelihood of—

- (a) fire spreading beyond the appliance; and
- (b) smoke from the appliance entering the building.

STATE AND TERRITORY VARIATIONS

F2.3.3(a) has been replaced in Tasmania as follows:

F2.3.3(a)

- (a) fire and harmful emissions spreading beyond the appliance; and

F2.3.4 Bushfire areas

A Class 1 building or a Class 10a building or deck associated with a Class 1 building constructed in a *designated bushfire prone area* is to provide resistance to bushfires in order to reduce the danger to life and reduce the risk of the loss of the building.

STATE AND TERRITORY VARIATIONS

F2.3.4 has been replaced in Tasmania as follows:

F2.3.4

A Class 1 building or a Class 10a building or deck associated with a Class 1 building constructed in a *designated bushfire prone area* is to—

- (a) provide resistance to bushfires in order to reduce the danger to life and reduce the risk of the loss of the building; and
- (b) be accessible for fire fighting and occupant evacuation; and
- (c) have access on the site to a water supply for fire fighting purposes.

PERFORMANCE PROVISIONS

F2.3.5 Private bushfire shelters

A structure designed for emergency occupation during a bushfire event must provide shelter to occupants from direct and indirect actions of a bushfire.

Application:

F2.3.5 only applies to a Class 10c building.

F2.3.6 Alpine areas

A building in an *alpine area* is to be provided with additional measures in view of the increased difficulties in fighting fire and maintaining access and means of egress in snow conditions.

PERFORMANCE REQUIREMENTS

P2.3.1 Protection from the spread of fire

- (a) A Class 1 building must be protected from the spread of fire from—
 - (i) another building other than an associated Class 10 building; and
 - (ii) the allotment boundary, other than a boundary adjoining a road or public space.
 (see **Figure 2.3.1**)
- (b) A Class 10a building must not significantly increase the risk of fire spread between Class 2 to 9 buildings.

STATE AND TERRITORY VARIATIONS

In South Australia after P2.3.1(a)(i) delete P2.3.1(a)(ii) and insert SA P2.3.1(a)(ii) and (iii) as follows:

- (ii) the allotment boundary, other than a boundary adjoining a road or public space; and
- (iii) a Class 10b *brush fence*.

PERFORMANCE PROVISIONS

Figure 2.3.1

TYPICAL AREAS OF POTENTIAL FIRE SPREAD

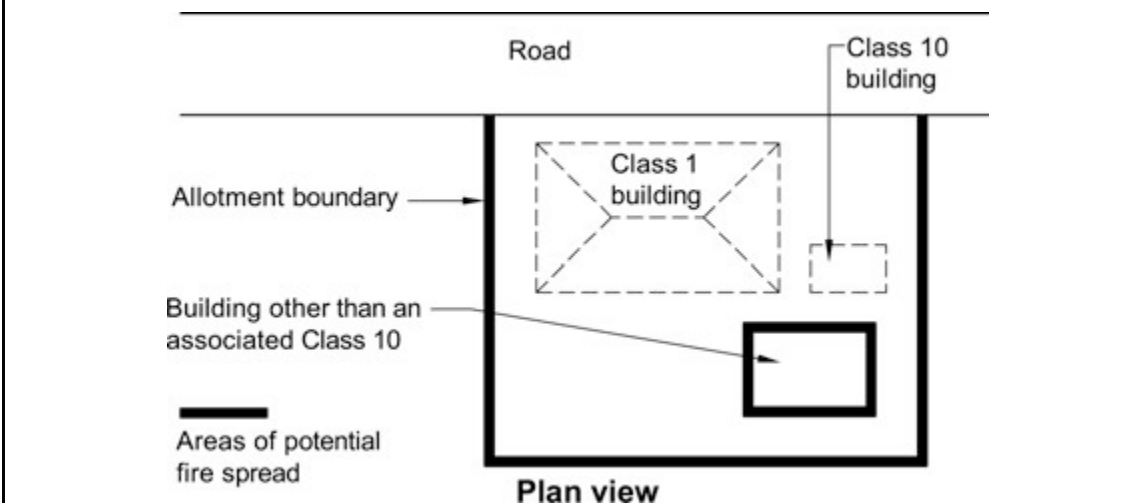

Note: This diagram indicates areas of potential fire spread. This situation will differ for corner allotments etc.

P2.3.2 Fire detection and early warning

In a Class 1 building, occupants must be provided with *automatic* warning on the detection of smoke so that they may evacuate in the event of a fire to a place of safety.

P2.3.3 Heating appliances

A heating appliance and its associated components within a building, including an open fire-place, chimney, or the like, must be installed—

- (a) to withstand the temperatures likely to be generated by the appliance; and
- (b) so that it does not raise the temperature of any building element to a level that would adversely affect the element's physical or mechanical properties or function; and
- (c) so that hot products of combustion will not—
 - (i) escape through the walls of the associated components; and
 - (ii) discharge in a position that will cause fire to spread to nearby *combustible* materials or allow smoke to penetrate through nearby *windows*, ventilation inlets, or the like in the building containing the heating appliance.

STATE AND TERRITORY VARIATIONS

P2.3.3(c) has been replaced in Tasmania as follows:

P2.3.3(c)

- (c) so that hot products of combustion will not—
- (i) escape through the walls of the associated components; and
 - (ii) discharge in a position that will cause fire to spread to nearby *combustible* materials or allow smoke to penetrate through nearby *windows*, ventilation inlets, or the like in the building containing the heating appliance; and
 - (iii) in the case of solid-fuel burning appliances, be discharged above appropriate emission limits.

P2.3.4 Bushfire areas

A Class 1 building or a Class 10a building or deck associated with a Class 1 building that is constructed in a *designated bushfire prone area* must, to the degree necessary, be designed and constructed to reduce the risk of ignition from a bushfire, appropriate to the—

- (a) potential for ignition caused by burning embers, radiant heat or flame generated by a bushfire; and
- (b) intensity of the bushfire attack on the building.

STATE AND TERRITORY VARIATIONS

P2.3.4 has been replaced in Tasmania as follows:

P2.3.4

A Class 1 building or a Class 10a building or deck associated with a Class 1 building that is constructed in a *designated bushfire prone area* must, to the degree necessary, be—

- (a) designed and constructed to reduce the risk of ignition from a bushfire, appropriate to the—
 - (i) potential for ignition caused by burning embers, radiant heat or flame generated by a bushfire; and
 - (ii) intensity of the bushfire attack on the building; and
- (b) provided with vehicular access to the *site* to assist fire fighting and emergency personnel defend the building or evacuate occupants; and
- (c) provided with access at all times to a sufficient supply of water for fire fighting purposes on the *site*.

P2.3.5 Private bushfire shelters

A *private bushfire shelter* must be designed and constructed to provide a tenable environment for occupants during the passage of untenable conditions arising from a bushfire event, appropriate to the—

- (a) location of the *private bushfire shelter* relative to fire hazards including—
 - (i) predominant vegetation; and

PERFORMANCE PROVISIONS

- (ii) adjacent buildings and structures; and
- (iii) allotment boundaries; and
- (iv) other combustible materials; and
- (b) occupancy of the *private bushfire shelter*; and
- (c) bushfire intensity having regard for the bushfire attack level; and
- (d) fire intensity from adjacent buildings and structures, allotment boundaries and other combustible materials; and
- (e) ready access to the *private bushfire shelter* from the associated dwelling and occupant egress after the fire; and
- (f) tenability within the *private bushfire shelter* for the estimated maximum period of occupancy; and
- (g) generation of smoke, heat and toxic gases from materials used to construct the *private bushfire shelter*; and
- (h) structural and fire loads and actions to which it may reasonably be subjected, appropriate to—
 - (i) the topography between the *private bushfire shelter* and the predominant vegetation or other fire hazards; and
 - (ii) the distance between the *private bushfire shelter* and the predominant vegetation or other fire hazards; and
 - (iii) the size of the potential fire source and fire intensity; and
 - (iv) wind loading; and
 - (v) potential impact from debris such as falling tree limbs; and
- (i) degree of external signage identifying the location of the *private bushfire shelter*; and
- (j) degree of internal signage identifying the design capacity and maximum period of occupancy; and
- (k) degree of occupant awareness of outside environmental conditions; and
- (l) degree of essential maintenance.

Application:

P2.3.5 only applies to a Class 10c building.

Note:

The *Housing Provisions* do not contain any *Deemed-to-Satisfy Provisions* for this *Performance Requirement*, however the ABCB Performance Standard for Private Bushfire Shelters Part 1, contains guidance for this *Performance Requirement*.

P2.3.6 Alpine areas

- (a) An external doorway from a building in an *alpine area* must be installed so that opening the door is not obstructed by snow or ice.

PERFORMANCE PROVISIONS

- (b) A building in an *alpine area* containing external trafficable structures forming part of the means of egress must be constructed so that they remain, as far as practicable, useable under snow conditions.
- (c) A building in an *alpine area* must be constructed so that snow or ice is not shed from the building onto the allotment, any adjoining allotment, road or public space in a location or manner that will—
 - (i) obstruct a means of egress from any building to a road or open space; or
 - (ii) otherwise endanger people.

PART 2.4 HEALTH AND AMENITY

OBJECTIVE

O2.4.1 Wet areas

The *Objective* is to safeguard the occupants from illness or injury and protect the building from damage caused by the accumulation of internal moisture arising from the use of *wet areas* in a building.

O2.4.2 Room heights

The *Objective* is to safeguard the occupants from injury or loss of amenity caused by inadequate height of a room or space.

O2.4.3 Facilities

The *Objective* is to—

- (a) safeguard occupants from illness caused by infection; and
- (b) safeguard occupants from loss of amenity arising from the absence of adequate personal hygiene facilities; and
- (c) enable occupants to carry out laundering; and
- (d) provide for facilities to enable food preparation; and
- (e) enable unconscious occupants of *sanitary compartments* to be removed from the compartment.

O2.4.4 Light

The *Objective* is to safeguard occupants from injury, illness or loss of amenity due to—

- (a) isolation from natural light; and
- (b) lack of adequate artificial lighting.

O2.4.5 Ventilation

The *Objective* is to safeguard occupants from illness or loss of amenity due to lack of air freshness.

O2.4.6 Sound insulation

The *Objective* is to safeguard occupants from illness or loss of amenity as a result of undue sound being transmitted between adjoining dwellings.

FUNCTIONAL STATEMENTS

F2.4.1 Wet areas

A building is to be constructed to avoid the likelihood of—

- (a) the creation of any unhealthy or dangerous conditions; or
- (b) damage to building elements,

caused by dampness or water overflow from bathrooms, laundries and the like.

F2.4.2 Room heights

A building is to be constructed to provide height in a room or space suitable for the intended use.

F2.4.3 Facilities

A building is to be provided with suitable—

- (a) space and facilities for personal hygiene; and
- (b) space or facilities for laundering; and
- (c) space and facilities for the preparation and cooking of food; and
- (d) space or other means to permit an unconscious occupant to be removed from a *sanitary compartment*; and
- (e) means for the sanitary disposal of waste water.

Application:

F2.4.3 only applies to a Class 1 building.

F2.4.4 Light

- (a) A *habitable room* within a building is to be provided with openings to admit adequate natural light consistent with its function or use; and
- (b) A space within a building used by occupants is to be provided with artificial lighting consistent with its function or use which, when activated in the absence of suitable natural light, will enable safe movement.

F2.4.5 Ventilation

A space used by occupants within a building is to be provided with adequate ventilation consistent with its function or use.

F2.4.6 Sound insulation

A building element which separates dwellings is to be constructed to prevent undue sound transmission between those dwellings.

PERFORMANCE REQUIREMENTS

P2.4.1 Wet areas

To protect the structure of the building and to maintain the amenity of the occupants, water must be prevented from penetrating—

- (a) behind fittings and linings; or
 - (b) into concealed spaces,
- of sanitary facilities, bathrooms, laundries and the like.

P2.4.2 Room heights

A room or space must be of a height that does not unduly interfere with its intended function.

P2.4.3 Facilities

- (a) Suitable sanitary facilities for personal hygiene must be provided in a convenient location within or associated with a building, appropriate to its function or use.
- (b) * * * * *

This clause has been deliberately left blank.

- (c) Laundering facilities or space for laundering facilities and the means for sanitary disposal of waste water must be provided in a convenient location within or associated with a building, appropriate to its function or use.
- (d) A food preparation facility must be provided which includes—
 - (i) a means for food rinsing, utensil washing and the sanitary disposal of associated waste water; and
 - (ii) a means for cooking food; and
 - (iii) a space for food preparation.
- (e) A *sanitary compartment* must be constructed with sufficient space or other means to enable an unconscious occupant to be removed from the compartment.

Application:

P2.4.3 only applies to a Class 1 building.

Explanatory information:

For the purposes of **P2.4.3(c)**, waste water includes water that is soiled as a result of clothes washing, mopping floors and other domestic cleaning processes.

P2.4.4 Light

- (a) A *habitable room* must be provided with *windows* so that natural light, when available, provides a level of *illuminance* appropriate to the function or use of that part of the building.

PERFORMANCE PROVISIONS

- (b) Artificial lighting must be installed to provide a level of *illuminance* appropriate to the function or use of the building to enable safe movement by occupants.

Application:

P2.4.4(b) only applies—

- (a) to *sanitary compartments*, bathrooms, shower rooms, airlocks, laundries and the like; and
 (b) if natural lighting of a suitable standard is not available.

P2.4.5 Ventilation

- (a) A space within a building used by occupants must be provided with means of ventilation with *outdoor air* which will maintain adequate air quality.
- (b) A mechanical air-handling system installed in a building must control—
- (i) the circulation of objectionable odours; and
 - (ii) the accumulation of harmful contamination by micro-organisms, pathogens and toxins.
- (c) Contaminated air must be disposed of in a manner which does not unduly create a nuisance or hazard to people in the building or *other property*.

P2.4.6 Sound insulation

- (a) Walls separating dwellings must provide insulation against the transmission of airborne sound sufficient to prevent illness or loss of amenity to the occupants.
- (b) Walls separating a bathroom, *sanitary compartment*, laundry or kitchen in a dwelling from a *habitable room* (other than a kitchen) in an adjoining dwelling, must provide insulation against impact generated sound sufficient to prevent illness or loss of amenity to the occupants.
- (c) The *required* sound insulation of walls must not be compromised by the incorporation or penetration of a pipe or other service element.

STATE AND TERRITORY VARIATIONS

In Northern Territory **P2.4.6** is replaced with the following:

P2.4.6 Sound insulation

- (a) Walls separating dwellings must provide insulation against the transmission of airborne and impact generated sound sufficient to prevent illness or loss of amenity to the occupants.
- (b) The *required* sound insulation of walls must not be compromised by the incorporation or penetration of a pipe or other service element.

PERFORMANCE PROVISIONS

VERIFICATION METHODS

V2.4.6 Sound insulation

Compliance with **P2.4.6(a)** and **(c)** to insulate against transmission of airborne sound through walls separating dwellings is verified when it is measured that the wall has a weighted standardised level difference with spectrum adaptation term ($D_{nT,w} + C_{tr}$) not less than 45 when determined under AS/NZS 1276.1 or ISO 717.1.

STATE AND TERRITORY VARIATIONS

V2.4.6 does not apply in Northern Territory.

PART 2.5 SAFE MOVEMENT AND ACCESS

OBJECTIVE

O2.5

The *Objective* is to—

- (a) provide people with safe access to and within a building; and
- (b) safeguard young children from drowning or injury in a *swimming pool*; and
- (c) safeguard people from drowning or injury due to suction by a *swimming pool* water recirculation system.

Application:

O2.5(b) and (c) only applies to a *swimming pool* with a depth of water more than 300 mm.

STATE AND TERRITORY VARIATIONS

1. **O2.5(b) applies in New South Wales** to a *swimming pool* with a depth of water of more than 300 mm, in conjunction with the Swimming Pools Act 1992 and the Swimming Pools Regulation 2008.
2. **O2.5(b) does not apply in the Northern Territory.**
3. **O2.5(b) does not apply in Queensland.**

Note: Restriction of access to *swimming pools* in Queensland is regulated under the Building Act 1975.

4. **O2.5(b) does not apply in Western Australia.**

Note: The restriction of access to private *swimming pools* is regulated under the Building Act 2011 and the Building Regulations 2012.

FUNCTIONAL STATEMENTS

F2.5.1 Safety from falling

A building is to provide safe access for people to the services and facilities within.

F2.5.2 Swimming pool access

A *swimming pool* is to be provided with—

- (a) means to restrict access to it by young children; and

PERFORMANCE PROVISIONS

- (b) means to reduce the possibility of a person being entrapped or injured due to suction by a water recirculation system.

Application:

F2.5.2 only applies to a *swimming pool* with a depth of water more than 300 mm.

STATE AND TERRITORY VARIATIONS

1. **F2.5.2(a) applies in New South Wales** to a *swimming pool* with a depth of water of more than 300 mm, in conjunction with the Swimming Pools Act 1992 and the Swimming Pools Regulation 2008.
2. **F2.5.2(a) does not apply in the Northern Territory.**
3. **F2.5.2(a) does not apply in Queensland.**

Note: Restriction of access to *swimming pools* in Queensland is regulated under the Building Act 1975.

4. **F2.5.2(a) does not apply in Western Australia.**

Note: The restriction of access to private *swimming pools* is regulated under the Building Act 2011 and the Building Regulations 2012.

PERFORMANCE REQUIREMENTS

P2.5.1 Stairways and ramps

So that people can move safely to and within a building—

- (a) walking surfaces must have safe gradients; and
- (b) any stairway or ramp must—
 - (i) have suitable handrails where necessary to assist and provide stability to people using the stairway or ramp; and
 - (ii) have suitable landings to avoid undue fatigue of users; and
 - (iii) be suitable for safe passage in relation to the nature, volume and frequency of likely usage; and
 - (iv) have slip-resistant walking surfaces on ramps, and on stairway treads or near the edge of the nosing.

P2.5.2 Barriers

Where people could fall—

- (a) 1 m or more—
 - (i) from a floor or roof or through an opening (other than through an openable window) in the *external wall*; or
 - (ii) due to a sudden change of level within or associated with a building; or
- (b) 2 m or more from a floor through an openable window in a bedroom; or

PERFORMANCE PROVISIONS

- (c) 4 m or more from a floor through an openable window not covered by (b), a barrier must be provided which must be—
- (d) continuous and extend for the full extent of the hazard; and
- (e) of a height to protect people from accidentally falling from the floor or roof or through the opening or openable window; and
- (f) constructed to prevent people from falling through the barrier; and
- (g) capable of restricting the passage of children; and
- (h) of strength and rigidity to withstand—
 - (i) the foreseeable impact of people; and
 - (ii) where appropriate, the static pressure of people pressing against it.

P2.5.3 Swimming pool access

A barrier must be provided to a *swimming pool* and must—

- (a) be continuous for the full extent of the hazard; and
- (b) be of a strength and rigidity to withstand the foreseeable impact of people; and
- (c) restrict the access of young children to the pool and the immediate pool surrounds; and
- (d) have any gates and doors fitted with latching devices not readily operated by young children, and constructed to automatically close and latch.

Application:

P2.5.3 only applies to a *swimming pool* with a depth of water more than 300 mm.

STATE AND TERRITORY VARIATIONS

1. **P2.5.3 applies in New South Wales** to a *swimming pool* with a depth of water of more than 300 mm, in conjunction with the Swimming Pools Act 1992 and the Swimming Pools Regulation 2008.
2. **P2.5.3 does not apply in the Northern Territory.**
3. **P2.5.3 does not apply in Queensland.**

Note: Restriction of access to *swimming pools* in Queensland is regulated under the Building Act 1975.

4. **P2.5.3 does not apply in Western Australia.**

Note: The restriction of access to private *swimming pools* is regulated under the Building Act 2011 and the Building Regulations 2012.

P2.5.4 Swimming pool water recirculation systems

A *swimming pool* water recirculation system must incorporate safety measures to avoid entrapment of, or injury to, a person.

Application:

P2.5.4 only applies to a *swimming pool* with a depth of water more than 300 mm.

VERIFICATION METHODS

V2.5.1 Wire barriers

Compliance with **P2.5.2(e)** and **(f)** for wire barriers is verified when the wire barrier passes the test described below:

(a) Application

The test must be carried out on either—

- (i) a prototype of a wire barrier that is identical to that proposed to be installed on site; or
- (ii) a wire barrier installed on site.

(b) Test equipment

The test equipment must consist of the following:

- (i) A horizontally suspended 125 mm diameter, 405 mm long cylinder of 1 mm thick steel having a highly polished 105 mm long cone at one end with a 20 mm diameter flat leading edge to which an eye bolt is fixed.
- (ii) A sufficiently flexible horizontal cable with mechanisms capable of applying and measuring a tension of 150 N (or a 15.3 kg weight suspended over a low friction pulley) is to be attached to the eye bolt (see **Figure V2.5.1**).
- (iii) A mechanism capable of measuring the tension force applied to each wire.

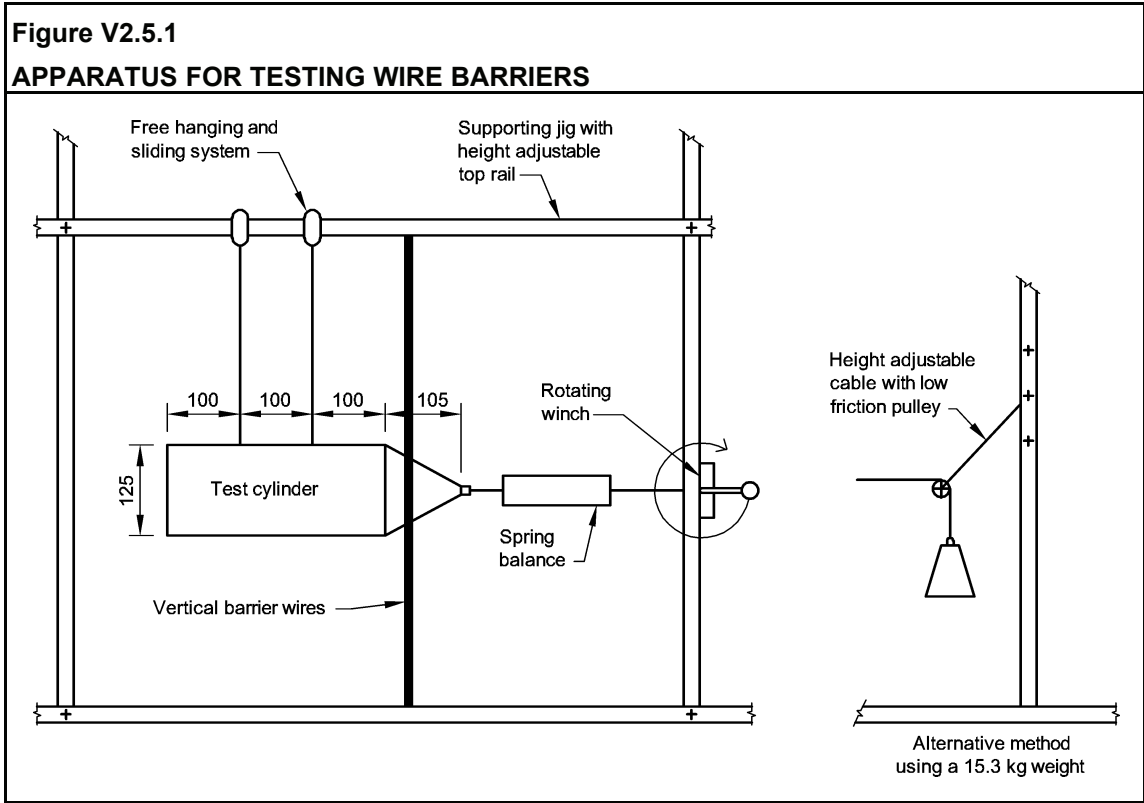

PERFORMANCE PROVISIONS

(c) Test procedure

The test procedure must be as follows:

- (i) Tension the wires, within their safe load, to the same tension in all wires and measure the tensions with a strain indicator.
- (ii) For—
 - (A) horizontal or near horizontal wires, position the cone against a pair of wires at the mid-span between supports, then apply the 150 N tension force to the cone; and
 - (B) vertical wires, position the cone against a pair of wires at the mid-span between supporting rails, then apply the 150 N tension force to the cone; and
 - (C) near-vertical wires, position the cone against a pair of wires at the widest opening between the wires, then apply the 150 N tension force to the cone.
- (iii) Attempt to pull the cone through the gap between the wires under the 150 N load, and—
 - (A) increase the tension in the wires and repeat (ii) until such time as the cone will not pull through; or
 - (B) if it does not pull through, reduce the tension in the wires and repeat step (ii); and
- (iv) When the cone is just prevented from pulling through the gap, the wires are at the correct tension in which case the cone is withdrawn and the tension recorded.
- (v) Reduce the tension in the wires and repeat steps (ii) to (iv) twice more, recording the tension in each case after the cone has been removed and then calculate the average of the three tensions as the *required* tension for each wire.
- (vi) For prototype tests of horizontal or near horizontal wires, record the deflection of each wire at the average tension calculated in accordance with (v) when a 2 kg mass is hung at mid-span between supports.

(d) Test report

The test report must include the following information:

- (i) The name and address of the person supervising the test.
- (ii) The test report number.
- (iii) The date of the test.
- (iv) The wire manufacturer's name and address, and specifications of the wires used in the test including the safe load limit of the wires.
- (v) The construction details of the test specimen, including a description and drawings and details of the components including supports, post or railing spacings and wire spacings.
- (vi) For a prototype test, the *required* tension calculated in accordance with (c)(v).
- (vii) For prototype tests of horizontal or near horizontal wires, the deflection measured in accordance with (c)(vi).

PART 2.6 ENERGY EFFICIENCY

STATE AND TERRITORY VARIATIONS

1. In New South Wales, **Part 2.6** does not apply.

Note: The New South Wales Additions contain energy efficiency measures that apply in New South Wales to support and complement BASIX.

2. In the Northern Territory, **Part 2.6** is replaced with BCA 2009 **Part 2.6**.

OBJECTIVE

O2.6

The *Objective* is to reduce greenhouse gas emissions.

STATE AND TERRITORY VARIATION

O2.6 is replaced in Victoria as follows:

O2.6

The *Objective* is to reduce greenhouse gas emissions and conserve water by efficiently using energy and water.

FUNCTIONAL STATEMENTS

F2.6

To reduce greenhouse gas emissions, to the degree necessary—

- (a) a building, including its *domestic services*, is to be capable of efficiently using energy; and
- (b) a building's *domestic services* for heating are to obtain their energy from—
 - (i) a low greenhouse gas intensity source; or
 - (ii) an on-site *renewable energy* source; or
 - (iii) another process as reclaimed energy.

Explanatory information:

1. The greenhouse gas intensity of energy sources vary. For example, natural gas has a low greenhouse gas intensity compared with electricity generated from coal.

PERFORMANCE PROVISIONS

2. For the purposes of **F2.6**, the *renewable energy* source must be on-site (so not Greenpower) and includes, but is not limited to, solar, wind, hydroelectric, wave action and geothermal.

STATE AND TERRITORY VARIATION

F2.6 is replaced in Victoria as follows:

F2.6

To reduce greenhouse gas emissions and conserve water, to the degree necessary—

- (a) a building, including its *domestic services*, is to be capable of efficiently using energy and water; and
- (b) a building's *domestic services* for heating are to obtain their energy from—
 - (i) a low greenhouse gas intensity source; or
 - (ii) an on-site *renewable energy* source; or
 - (iii) another process as reclaimed energy.

PERFORMANCE REQUIREMENTS

P2.6.1 Building

A building must have, to the degree necessary, a level of thermal performance to facilitate the efficient use of energy for artificial heating and cooling appropriate to—

- (a) the function and use of the building; and
- (b) the internal environment; and
- (c) the geographic location of the building; and
- (d) the effects of nearby permanent features such as topography, structures and buildings; and
- (e) solar radiation being—
 - (i) utilised for heating; and
 - (ii) controlled to minimise energy for cooling; and
- (f) the sealing of the building *envelope* against air leakage; and
- (g) the utilisation of air movement to assist cooling.

Explanatory information:

The term “facilitate” is used in **P2.6.1** to highlight the need to consider the installation of energy efficiency measures in a building where there is a likelihood that an artificial heating or cooling system will be installed in the building irrespective of the initial design.

In **P2.6.1(d)** the term “permanent” is used to describe features that will have a long term impact on the building and includes natural features of the landscape, such as mountains and escarpments, while permanent man made features would be buildings likely to be in place for a long period of time.

PERFORMANCE PROVISIONS

STATE AND TERRITORY VARIATION

P2.6.1 is replaced in Victoria as follows:

P2.6.1 Building

A building must have, to the degree necessary, a level of thermal performance to facilitate the efficient use of energy for artificial heating and cooling and a level of water use performance to facilitate the efficient use of water, appropriate to—

- (a) the function and use of the building; and
- (b) the internal environment; and
- (c) the geographic location of the building; and
- (d) the effects of nearby permanent features such as topography, structures and buildings; and
- (e) solar radiation being—
 - (i) utilised for heating; and
 - (ii) controlled to minimise energy for cooling; and
- (f) the sealing of the building *envelope* against air leakage; and
- (g) the utilisation of air movement to assist cooling; and
- (h) water resources available; and
- (i) pertinent water management measures of the responsible water authority.

P2.6.2 Services

Domestic services, including any associated distribution system and components must, to the degree necessary—

- (a) have features that facilitate the efficient use of energy appropriate to—
 - (i) the *domestic service* and its usage; and
 - (ii) the geographic location of the building; and
 - (iii) the location of the *domestic service*; and
 - (iv) the energy source; and
- (b) obtain heating energy from—
 - (i) a source that has a greenhouse gas intensity that does not exceed 100 g CO₂-e/MJ of thermal energy load; or
 - (ii) an on-site *renewable energy* source; or
 - (iii) another process as reclaimed energy.

Explanatory information:

1. For **(a)(iv)** the energy source can be a consideration if, for example, *renewable energy* such as electricity from a photovoltaic panel or a wind turbine was used to meet or supplement the lighting or cooling electricity load. For **(b)(ii)** similar sources could meet or supplement the heating load.

PERFORMANCE PROVISIONS

2. The intent of **P2.6.2(b)** is to constrain the use of a high greenhouse gas intensity source of energy. It does not prevent the use of electricity because the greenhouse gas intensity is related to the thermal load rather than the energy consumption which is covered by **P2.6.2(a)**. **P2.6.2** also contains the qualification that it is to be applied "to the degree necessary", allowing electricity to be used, even by low efficiency plant when there are no reasonable alternatives.
3. For the purposes of **P2.6.2** the *renewable energy* source must be on-site (so not Greenpower) and includes, but is not limited to, solar, wind, hydroelectric, wave action and geothermal.

STATE AND TERRITORY VARIATION

In Victoria, **P2.6.2** does not apply to a hot water supply system.

Note: In Victoria, the design and installation of a hot water supply system is regulated under the Plumbing Regulations 2008.

VERIFICATION METHODS

V2.6 Definitions

The following definitions are used in this Part:

Cooling load means the calculated amount of energy removed from the cooled spaces of the building annually by artificial means to maintain the desired temperatures in those spaces.

Heating load means the calculated amount of energy delivered to the heated spaces of the building annually by artificial means to maintain the desired temperatures in those spaces.

Reference building means a hypothetical building that is used to determine the maximum allowable *heating load* and *cooling load* for the proposed building.

V2.6.1 Application of this Part

The *Verification Methods* in this Part only apply to—

- (a) a Class 1 building; and
- (b) an enclosed Class 10a building attached to a Class 1 building.

Explanatory information:

The *Verification Methods* in this Part are intended to apply to whole Class 1 buildings and to whole Class 1 buildings that incorporate attached and enclosed Class 10a parts, such as attached garages. The *Verification Methods* are not intended to apply to detached garages or to open carports.

PERFORMANCE PROVISIONS

STATE AND TERRITORY VARIATION

V2.6.1 is replaced in Victoria as follows:

V2.6.1 Application of this Part

The *Verification Methods* in this Part only apply to—

- (a) a new Class 1 building that has either a rainwater tank connected to all sanitary flushing systems, or a solar water heater system, installed in accordance with the Plumbing Regulations 2008; and
- (b) a Class 1 building other than a new Class 1 building; and
- (c) an enclosed Class 10a building attached to a Class 1 building.

V2.6.2 * * * * *

This clause has deliberately been left blank.

V2.6.2.1 * * * * *

This clause has deliberately been left blank.

V2.6.2.2 Verification using a reference building

- (a) Compliance with P2.6.1 is verified when a proposed building, compared with a *reference building*, has—
 - (i) in *climate zones* 1 and 2, a *cooling load* equal to or less than that of the *reference building*; or
 - (ii) in *climate zones* 7 and 8, a *heating load* equal to or less than that of the *reference building*; or
 - (iii) in *climate zones* 3, 4, 5 and 6, a *heating load* and a *cooling load* equal to or less than that of the *reference building*.
- (b) The *heating load* and *cooling load* for the proposed building and the *reference building* must be determined using the same—
 - (i) calculation method; and
 - (ii) location specific data, including that of climate and topography appropriate to the location where the proposed building is to be constructed if the data is available, or the nearest location with similar climatic conditions in the same *climate zone* for which the data is available; and
 - (iii) impact of adjoining structures and features; and
 - (iv) soil conditions; and
 - (v) orientation; and
 - (vi) floor plan, including the location of *glazing*; and
 - (vii) ceiling height and number of storeys; and
 - (viii) solar absorptance of external surfaces; and
 - (ix) roof pitch, roof cladding and *roof lights*; and

PERFORMANCE PROVISIONS

- (x) *separating walls*; and
 - (xi) external non-glazed doors; and
 - (xii) intermediate floors; and
 - (xiii) floor and floor coverings; and
 - (xiv) internal zones; and
 - (xv) internal heat gains including people and appliances.
- (c) The calculation method used must be capable of assessing the *heating load* and *cooling load* by modelling—
- (i) the building *fabric*; and
 - (ii) *glazing* and shading; and
 - (iii) air infiltration and ventilation; and
 - (iv) the function and use of the building including zoning, hours of occupation, hours of heating and cooling availability and internal heat gains; and
 - (v) space temperature settings in the range 20°C to 21°C for heating and 25°C to 28°C for cooling; and
 - (vi) relevant built-environment and topographical features; and
 - (vii) the sensible heat component of the *cooling load* and *heating load*.
- (d) Climatic data employed in the calculation method must be based on hourly recorded values and be representative of a typical year for the proposed location.
- (e) The *reference building* must be modelled using the *Deemed-to-Satisfy Provisions* of **Part 3.12** in accordance with **3.12.0(a)(ii)**.

Explanatory information:

1. In **(c)(iv)**, the number of hours per day for which heating and cooling is available would be expected to lie between 8 and 17, with values outside this range unlikely in other than exceptional circumstances.
2. Suitable climatic data including dry-bulb temperature, direct and diffuse solar radiation, wind speed, wind direction and cloud cover can be obtained from the Australian national climate database.

V2.6.3 * * * * *

This clause has deliberately been left blank.

Explanatory information:

The content of **V2.6.3**, which existed in BCA 2013, has been moved to **Part B2** of NCC Volume Three — Plumbing Code of Australia.

ACCEPTABLE CONSTRUCTION

Introduction

The scope of these provisions

Suitability of Alternative Solutions

The use of maps

Consultation with appropriate authorities

Layout of Parts 3.1 to 3.12

How to use the requirements of each Part

SECTION 3 CONTENTS

SECTION 3 ACCEPTABLE CONSTRUCTION

3.0 How to Use Section 3

Introduction
The scope of these provisions
Suitability of Alternative Solutions
The use of maps
Consultation with appropriate authorities
Layout of Parts 3.1 to 3.12
How to use the requirements of each Part

PART 3.1 SITE PREPARATION

Explanatory Information

3.1.1 Earthworks

3.1.1.0 Application
3.1.1.1 Earthworks
3.1.1.2 Excavation adjacent to vacant adjoining property
3.1.1.3 Excavation adjacent to existing buildings
3.1.1.4 Fill

3.1.2 Drainage

3.1.2.0 Acceptable construction manuals
3.1.2.1 Application
3.1.2.2 Drainage requirements
3.1.2.3 Surface water drainage
3.1.2.4 Subsoil drainage
3.1.2.5 Stormwater drainage

3.1.3 Termite Risk Management

3.1 Definitions
3.1.3 Application of this Part
3.1.3.0 Acceptable construction manual
3.1.3.1 Application
3.1.3.2 Installation of termite management systems
3.1.3.3 Concrete slab-on-ground edge exposure
3.1.3.4 Sheet materials
3.1.3.5 Granular material
3.1.3.6 Chemical
3.1.3.7 Attachments to buildings

PART 3.2 FOOTINGS AND SLABS

Explanatory Information

3.2 Footings and Slabs

3.2 Definitions

3.2.0 Acceptable construction manuals

3.2.1 Application

3.2.2 Preparation

3.2.2.1 Excavation for footings

3.2.2.2 Filling under concrete slabs

3.2.2.3 Foundations for footings and slabs

3.2.2.4 Slab edge support on sloping sites

3.2.2.5 Stepped footings

3.2.2.6 Vapour barriers

3.2.2.7 Edge rebates

3.2.3 Concrete and Reinforcing

3.2.3.1 Concrete

3.2.3.2 Steel reinforcement

3.2.4 Site Classification

3.2.4.1 Site classification

3.2.5 Footing and Slab Construction

3.2.5.1 Footing and slab construction

3.2.5.2 Footings and slabs to extensions to existing buildings

3.2.5.3 Shrinkage control

3.2.5.4 Minimum edge beam dimensions

3.2.5.5 Footings for fireplaces on Class A and S sites

3.2.5.6 Stump footing details

PART 3.3 MASONRY

3.3 Definitions

3.3.1 Unreinforced Masonry

3.3.1.0 Acceptable construction manual

3.3.2 Reinforced Masonry

3.3.2.0 Acceptable construction manual

3.3.3 Masonry Accessories

3.3.3.0 Acceptable construction manual

3.3.4 Weatherproofing of Masonry

3.3.4 Application of this Part

3.3.4.0 Acceptable construction manual

3.3.5 Earthwall Construction

PART 3.4 FRAMING

3.4.0 Framing

- 3.4.0.1 Explanation of terms
- 3.4.0.2 Structural Software

3.4.1 Sub-Floor Ventilation

- 3.4.1.1 Application
- 3.4.1.2 Sub-floor ventilation

3.4.2 Steel Framing

- 3.4.2.0 Acceptable construction manuals
- 3.4.2.1 Application
- 3.4.2.2 General
- 3.4.2.3 Steel floor framing
- 3.4.2.4 * * * * *
- 3.4.2.5 * * * * *
- 3.4.2.6 Installation of services

3.4.3 Timber Framing

- 3.4.3.0 Acceptable construction manuals

3.4.4 Structural Steel Members

- 3.4.4 Explanation of Terms
- 3.4.4.0 Acceptable construction manuals
- 3.4.4.1 Application
- 3.4.4.2 Structural steel members
- 3.4.4.3 Columns
- 3.4.4.4 Corrosion protection

PART 3.5 ROOF AND WALL CLADDING

Explanatory Information

3.5.1 Roof cladding

- 3.5.1.0 Acceptable construction manuals
- 3.5.1.1 Application
- 3.5.1.2 Roof tiling
- 3.5.1.3 Metal sheet roofing

3.5.2 Gutters and downpipes

- 3.5.2.0 Acceptable construction manuals
- 3.5.2.1 Application
- 3.5.2.2 Materials
- 3.5.2.3 Selection of guttering
- 3.5.2.4 Installation of gutters
- 3.5.2.5 Downpipes — size and installation

3.5.3 Wall Cladding

- 3.5.3.0 Acceptable construction manual
- 3.5.3.1 Application
- 3.5.3.2 Timber weatherboard cladding
- 3.5.3.3 Wall cladding boards
- 3.5.3.4 Sheet wall cladding
- 3.5.3.5 Eaves and soffit linings
- 3.5.3.6 Flashings to wall openings

PART 3.6 GLAZING

3.6 Glazing

- 3.6 Definitions
- 3.6.0 Acceptable construction manuals
- 3.6.1 Application
- 3.6.2 Glazing sizes and installation
- 3.6.3 Fully framed glazing installed in perimeter of buildings
- 3.6.4 Human impact safety requirements
 - 3.6.4.1 Doors
 - 3.6.4.2 Door side panels
 - 3.6.4.3 Full height framed glazed panels
 - 3.6.4.4 Glazed panels, other than doors or side panels, on the perimeter of rooms
 - 3.6.4.5 Bathroom, ensuite and spa room glazing
 - 3.6.4.6 Visibility of glazing

PART 3.7 FIRE SAFETY

3.7.1 Fire separation

- 3.7.1.1 Application
- 3.7.1.2 General concession — non-combustible materials
- 3.7.1.3 External walls of Class 1 buildings
- 3.7.1.4 Measurement of distances
- 3.7.1.5 Construction of external walls
- 3.7.1.6 Class 10a buildings
- 3.7.1.7 Allowable encroachments
- 3.7.1.8 Separating walls
- 3.7.1.9 Fire hazard properties
- 3.7.1.10 Roof lights

3.7.2 Smoke alarms

- 3.7.2.1 Application
- 3.7.2.2 Requirements for smoke alarms
- 3.7.2.3 Location — Class 1a buildings
- 3.7.2.4 Location — Class 1b buildings
- 3.7.2.5 Lighting to assist evacuation — Class 1b buildings

3.7.3 Heating appliances

- 3.7.3.0 Acceptable construction manuals
- 3.7.3.1 Application
- 3.7.3.2 Open fireplace construction
- 3.7.3.3 Chimney construction

- 3.7.3.4 Installation of insert fireplaces and flues
- 3.7.3.5 Installation of free standing heating appliances

3.7.4 Bushfire areas

- 3.7.4.0 Acceptable construction manual

3.7.5 Alpine areas

- 3.7.5.1 Application
- 3.7.5.2 External doorways
- 3.7.5.3 External ramps
- 3.7.5.4 Discharge of external doorways providing a means of egress
- 3.7.5.5 External trafficable structures

PART 3.8 HEALTH AND AMENITY

3.8.1 Wet areas and external waterproofing

- 3.8.1 Definitions
 - 3.8.1.1 Application
 - 3.8.1.2 Wet areas
 - 3.8.1.3 External above ground membranes

3.8.2 Room heights

- 3.8.2.1 Application
- 3.8.2.2 Ceiling heights

3.8.3 Facilities

- 3.8.3.1 Application
- 3.8.3.2 Required facilities
- 3.8.3.3 Construction of sanitary compartments

3.8.4 Light

- 3.8.4.1 Application
- 3.8.4.2 Natural lighting
- 3.8.4.3 Artificial lighting

3.8.5 Ventilation

- 3.8.5.0 Acceptable construction manual
- 3.8.5.1 Application
- 3.8.5.2 Ventilation requirements
- 3.8.5.3 Location of sanitary compartments

3.8.6 Sound insulation

- 3.8.6.1 Application
- 3.8.6.2 Sound insulation requirements
- 3.8.6.3 General installation requirements for walls
- 3.8.6.4 Services

PART 3.9 SAFE MOVEMENT AND ACCESS

3.9.1 Stair construction

- 3.9.1 Definitions
 - 3.9.1.1 Application
 - 3.9.1.2 General requirements
 - 3.9.1.3 Stair construction
 - 3.9.1.4 Riser and going dimensions
 - 3.9.1.5 Thresholds

3.9.2 Barriers and handrails

- 3.9.2.1 Application
- 3.9.2.2 Barriers to prevent falls
- 3.9.2.3 Construction of barriers to prevent falls
- 3.9.2.4 Handrails
- 3.9.2.5 Protection of openable windows

3.9.3 Swimming pool access

- 3.9.3.0 Acceptable construction manuals

3.9.4 Swimming pool water recirculation systems

- 3.9.4.0 Acceptable construction manual

PART 3.10 ADDITIONAL CONSTRUCTION REQUIREMENTS

Explanatory Information

3.10.1 High Wind Areas

- 3.10.1.0 Acceptable construction manuals

3.10.2 Earthquake Areas

- 3.10.2.0 Acceptable construction manuals

3.10.3 Flood Hazard Areas

- 3.10.3.0 Acceptable construction manual

PART 3.11 STRUCTURAL DESIGN MANUALS

Explanatory Information

3.11 Structural design manuals

- 3.11.1 Application
- 3.11.2 Resistance to actions
- 3.11.3 Determination of individual actions
- 3.11.4 * * * * *
- 3.11.5 * * * * *
- 3.11.6 Determination of structural resistance of materials and forms of construction

PART 3.12 ENERGY EFFICIENCY

3.12 Energy efficiency

- 3.12 Definitions
 - 3.12.0 Application of Part 3.12

3.12.0.1 Heating and cooling loads

3.12.1 Building fabric

3.12.1 Application

3.12.1.1 Building fabric thermal insulation

3.12.1.2 Roofs

3.12.1.3 Roof lights

3.12.1.4 External walls

3.12.1.5 Floors

3.12.1.6 Attached Class 10a buildings

3.12.2 External Glazing

3.12.2 Application

3.12.2.1 External glazing

3.12.2.2 Shading

3.12.3 Building Sealing

3.12.3 Application

3.12.3.1 Chimneys and flues

3.12.3.2 Roof lights

3.12.3.3 External windows and doors

3.12.3.4 Exhaust fans

3.12.3.5 Construction of roofs, walls and floors

3.12.3.6 Evaporative coolers

3.12.4 Air Movement

3.12.4 Application

3.12.4.1 Air movement

3.12.4.2 Ventilation openings

3.12.4.3 Ceiling fans and evaporative coolers

3.12.5 Services

3.12.5 Application

3.12.5.0 Acceptable construction manual

3.12.5.1 Insulation of services

3.12.5.2 Central heating water piping

3.12.5.3 Heating and cooling ductwork

3.12.5.4 Electric Resistance space heating

3.12.5.5 Artificial lighting

3.12.5.6 Water heater in a heated water system

3.12.5.7 Swimming pool heating and pumping

3.12.5.8 Spa pool heating and pumping

PART 3.0 HOW TO USE SECTION 3

Explanatory information:

This is a non mandatory guide on how to use Section 3 of the *Housing Provisions*.

3.1 Introduction

Section 3, **Parts 3.1** to **3.12** are *Deemed-to-Satisfy Provisions* that are considered to be acceptable forms of construction that meet the legislative requirements for complying with the *Housing Provisions* (i.e. they comply with the *Performance Requirements* listed in Section 2 of the *Housing Provisions*).

There is no obligation to adopt any particular option contained in Section 3 of the *Housing Provisions*, if it is preferred to meet the *Performance Requirement* in some other way.

However, if one of the options described in Section 3 is not complied with, then the *appropriate authority* must be satisfied that the *Performance Requirements* have been met.

3.2 The scope of these provisions

The *Deemed-to-Satisfy Provisions* (described as “acceptable construction practice” or “acceptable construction manuals”) are indicative of some of the most common forms of national construction practice. In general, either the “acceptable construction practice” or the “acceptable construction manual” may be used as options when proposing a Deemed-to-Satisfy solution.

However, it should be noted that some of these options described as “acceptable construction practice” may have very specific limitations and accordingly will not be suitable for all applications. In the case of the “acceptable construction practice”, these limitations generally relate to climatic (*design wind speed*), geographical and topographical conditions and building geometry or in specific cases, may have a limiting scope that does not fully cover the subject matter of the Part. In the case of the “acceptable construction manual”, the scope may be limited to specific components of the subject matter.

If the “acceptable construction practice” option is not suitable for the proposed construction or *site* conditions, an alternative approach may be found in one of the “acceptable construction manuals” listed at the start of each Part. Similarly, if a particular building element or component *required* to comply with the *Housing Provisions* is not contained in the scope of the “acceptable construction practice”, reference to the appropriate “acceptable construction manual” or **Part 3.11** will need to be made in addition to the “acceptable construction practice”.

Situations where it is necessary for a mixed application of the “acceptable construction practice” and the “acceptable construction manual” may be identified by reference to differing components of the *Performance Requirement* (see **1.0.7(b)**).

3.3 Suitability of Alternative Solutions

The options described in Section 3 are typical examples. They are certainly not the only means available of complying with the *Housing Provisions*. The performance nature of this document provides flexibility and allows the use of alternative construction methods even though they may

ACCEPTABLE CONSTRUCTION

not be specifically described in an acceptable construction manual or as acceptable construction practice.

Alternative Solutions may be used provided they comply with the *Performance Requirements* listed in Section 2 (for further explanation see **Part 1.0**).

3.4 The use of maps

Maps have been used throughout Section 3 to indicate areas where particular requirements apply. These maps are indicative and some variation in conditions will apply, especially on the border of marked areas.

It is recommended that the *appropriate authority* be consulted and in most cases they may be able to identify what conditions apply in such areas at the early stage of building design.

3.5 Consultation with appropriate authorities

When building in certain locations there may be local conditions that may limit the type of construction that can be used. This is particularly important with *design wind speed* classifications and soil types.

Appropriate authorities have a wide range of experience and information on the geographical and topographical conditions found in their area of responsibility, and should be consulted during the initial design stage.

3.6 Layout of Parts 3.1 to 3.12

Parts 3.1 to 3.12 of the *Housing Provisions* are organised in a manner that follows the logical construction sequence of a building. The following chart outlines some of the more frequently used details and where it is located in this document.

ACCEPTABLE CONSTRUCTION

INFORMATION GUIDE	
Relevant Part	Part Reference
Earthwork	3.1.1
Location of buildings (fire safety)	3.7.1
Facilities required	3.8.3
Room heights	3.8.2
Light and ventilation	3.8.4 and 3.8.5
Energy Efficiency	3.12
Site preparation	3.1.2 and 3.1.3
Footing and slabs	3.2
Masonry	3.3
Framing	3.4
Roof and wall cladding	3.5
Glazing	3.6
Balustrades	3.9.2
Wet area waterproofing	3.8.1
Sound insulation	3.8.6
Swimming pool access	3.9.3
Termite risk management	3.1.3
Earth wall construction	3.3.5
Smoke alarms	3.7.2
Heating appliances	3.7.3
High wind areas	3.10.1
Bushfire areas	3.7.4
Alpine areas	3.7.5
Earthquake areas	3.10.2

3.7 How to use the requirements of each Part

The following is an example page layout from [Part 3.2](#). This diagram explains the concepts behind typical clauses contained throughout [Parts 3.1](#) to [3.12](#).

ACCEPTABLE CONSTRUCTION

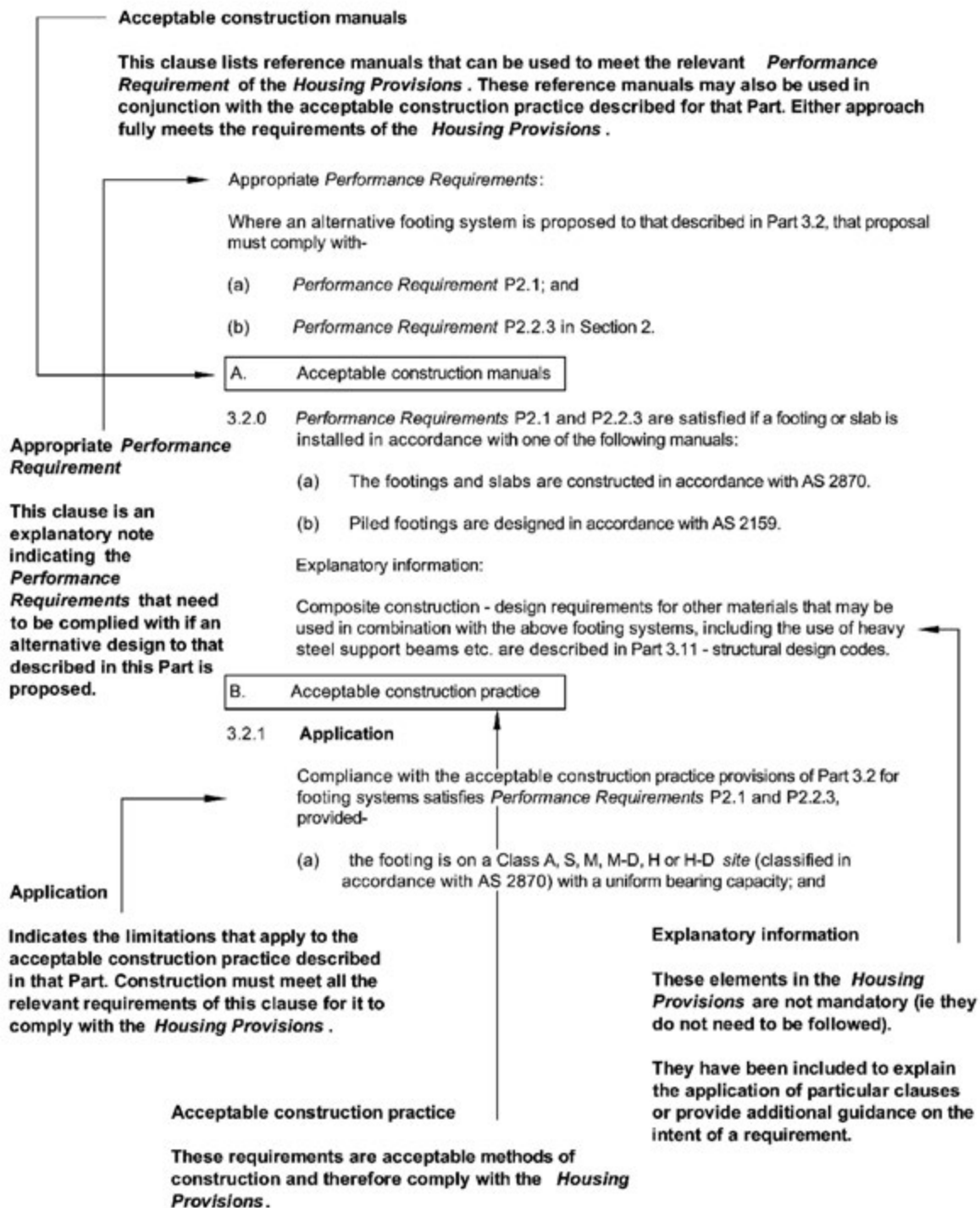

PART **3.1**

SITE PREPARATION

- 3.1.1 Earthworks**
- 3.1.2 Drainage**
- 3.1.3 Termite risk management**

PART 3.1 CONTENTS

PART 3.1 SITE PREPARATION

Explanatory Information

3.1.1 Earthworks

- 3.1.1.0 Application
- 3.1.1.1 Earthworks
- 3.1.1.2 Excavation adjacent to vacant adjoining property
- 3.1.1.3 Excavation adjacent to existing buildings
- 3.1.1.4 Fill

3.1.2 Drainage

- 3.1.2.0 Acceptable construction manuals
- 3.1.2.1 Application
- 3.1.2.2 Drainage requirements
- 3.1.2.3 Surface water drainage
- 3.1.2.4 Subsoil drainage
- 3.1.2.5 Stormwater drainage

3.1.3 Termite Risk Management

- 3.1 Definitions
- 3.1.3 Application of this Part
- 3.1.3.0 Acceptable construction manual
- 3.1.3.1 Application
- 3.1.3.2 Installation of termite management systems
- 3.1.3.3 Concrete slab-on-ground edge exposure
- 3.1.3.4 Sheet materials
- 3.1.3.5 Granular material
- 3.1.3.6 Chemical
- 3.1.3.7 Attachments to buildings

PART 3.1 EXPLANATORY INFORMATION

Explanatory information:

These provisions relate to general *site* preparation for footings, services, drainage and installation of termite management systems. It should be noted that other construction methods may be used to achieve the same results as specified in this Part provided they comply with the appropriate *Performance Requirement*.

PART 3.1.1 EARTHWORKS

Appropriate *Performance Requirements*:

Where an alternative approach to earthworks is proposed as an *Alternative Solution* to that described in **Part 3.1.1**, that proposal must comply with—

- (a) *Performance Requirement P2.1.1*; and
- (b) the relevant *Performance Requirements* determined in accordance with **1.0.10**.

STATE AND TERRITORY VARIATIONS

Except for **Table 3.1.1.1** as referenced by **Figure 3.1.2.1** and except for **Clause 3.1.1.0(b)** for determination of a normal site as referenced by **Clause 3.2.1**, **Part 3.1.1** does not apply in New South Wales.

Note: In New South Wales requirements for shoring and adequacy of excavation works are a prescribed condition of development consent. In addition consent authorities can place specific controls on siteworks associated with the construction of a building, by imposing further conditions of development consent. Information addressing siteworks can be found in the Department of Planning and Environment – Act and Regulation note "Health, safety and amenity during construction".

Acceptable construction practice

3.1.1.0 Application

Compliance with this acceptable construction practice satisfies *Performance Requirement P2.1.1* for earthworks provided:

- (a) The work is undertaken in normal *site* conditions.
- (b) For the purposes of this Part, normal *site* conditions are defined by the following parameters—
 - (i) a *site* that is classified as A, S, M, H or E in accordance with **Part 3.2**; and
 - (ii) moisture conditions on *site* are as a result of seasonal and climatic changes; and
 - (iii) the *site* is not subject to unusual moisture conditions caused by drains, dams, channels, ponds or tanks which are maintained or removed from the *site*; and
 - (iv) large trees have not been recently removed from the *site*; and
 - (v) soil moisture conditions have not been significantly modified by the removal of buildings or other structures; and
 - (vi) drainage on the allotment is maintained.

SITE PREPARATION

Explanatory information:

The provisions described in **Part 3.1.1** will enable earthworks to be carried out safely and avoid potential damage to adjoining structures and property through the soil collapsing or subsiding during building works. Exceptional *site* conditions (including the effects of torrential rain) may need special consideration and additional advice from appropriately qualified people should be considered.

State and Territory legislation may also have requirements that affect the excavation, especially in relation to adjoining property and notification to owners of that property. Advice should be obtained from the *appropriate authority* before commencement of works.

3.1.1.1 Earthworks

Excavation and fill utilising unprotected embankments can be undertaken in accordance with—

- (a) **Table 3.1.1.1** for general earthwork; or
- (b) **3.1.1.2** for excavation adjacent to vacant adjoining property; or
- (c) **3.1.1.3** for excavation adjacent to existing buildings; or
- (d) **3.1.1.4** for fill adjacent to adjoining property.

3.1.1.2 Excavation adjacent to vacant adjoining property

Excavation work, using unprotected embankments, adjacent to another allotment can be undertaken provided—

- (a) there are no buildings or structures on the adjoining allotment within 3 m of the allotment boundary adjacent to the excavation; and
- (b) the excavation commences at the allotment boundary and is within the area defined as being suitable for excavation in **Figure 3.1.1.1**; and
- (c) the slope of the unprotected embankment of the excavation complies with the appropriate soil classification slope described in **Table 3.1.1.1**.

3.1.1.3 Excavation adjacent to existing buildings

Excavation work for footings, drainage trenches or other similar works, adjacent to existing buildings can be undertaken provided—

- (a) the angle to determine the safe area for excavation is taken from the bottom of the shallowest point of the existing footing in accordance with **Figure 3.1.1.2**; and
- (b) the excavation is within the area defined as being suitable for excavation in **Figure 3.1.1.2**; and
- (c) the slope of the unprotected embankment of the excavation complies with the appropriate soil classification described in **Table 3.1.1.1**; and
- (d) for footing excavation adjacent to existing footings—
 - (i) the footing is placed as soon as practicable after exposing the existing footing; and
 - (ii) the existing footing, where on an adjoining property, is completely isolated from the new footing by means of a flexible bond breaker not less than 10 mm thick; and
- (e) the adjoining footing is not left exposed at the completion of works.

SITE PREPARATION

Figure 3.1.1.1

EXCAVATION AFFECTING ADJOINING PROPERTY

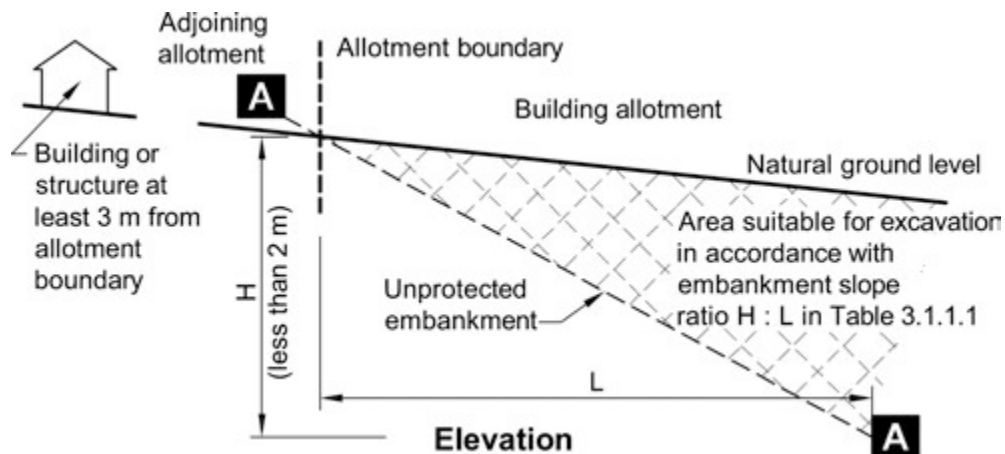

Note: The angle for line A–A is defined in Table 3.1.1.1.

Figure 3.1.1.2

EXCAVATION ADJACENT TO EXISTING BUILDINGS

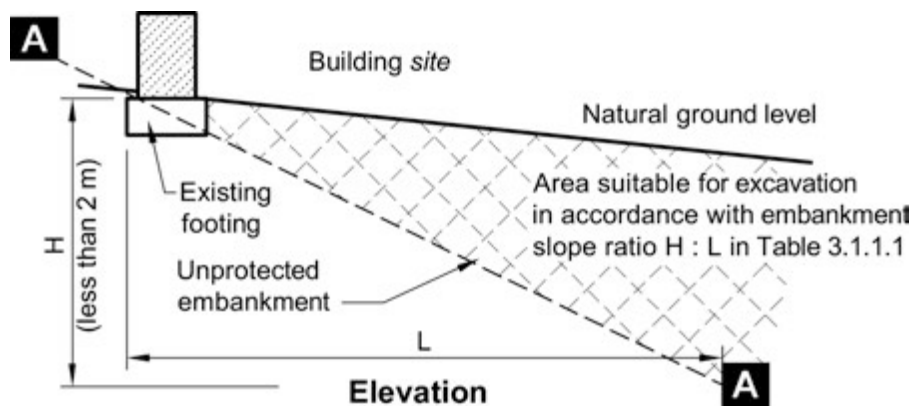

Note: Line A–A is defined in Table 3.1.1.1 and taken from the bottom of the shallowest point of the existing footing.

3.1.1.4 Fill

Filling works may be carried out provided—

- (a) where the fill is deeper than existing soil level, the gradient of the fill complies with [Table 3.1.1.1](#); and
- (b) where the fill is to be used to support footings or slabs, it is placed and compacted in accordance with [Part 3.2](#).

SITE PREPARATION

Table 3.1.1.1

UNPROTECTED EMBANKMENTS

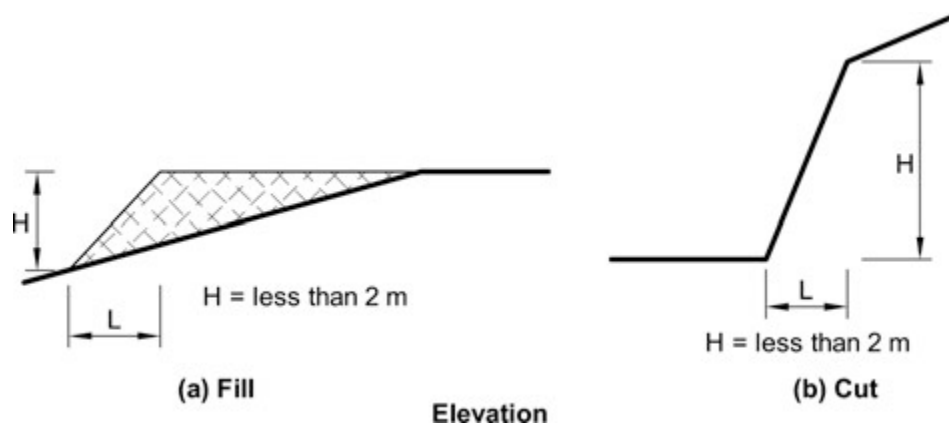

SOIL TYPE (*see Part 3.2.4 for material description)	EMBANKMENT SLOPES H:L	
	Compacted fill (see Part 3.2)	Cut
Stable rock (A*)	2:3	8:1
Sand (A*)	1:2	1:2
Silt (P*)	1:4	1:4
Clay	Firm clay	1:2
	Soft clay	Not suitable
Soft soils (P*)	Not suitable	Not suitable

Notes:

- Retaining walls or other types of soil retaining methods must be installed where—
 - the embankment slope is steeper than that described in this Table; or
 - the soil type is not described in this Table.
- Embankments that are to be left exposed at the end of the construction works must be stabilised by vegetation or similar works to prevent soil erosion.

PART 3.1.2 DRAINAGE

Appropriate *Performance Requirements*:

Where an alternative drainage system is proposed as an *Alternative Solution* to that described in **Part 3.1.2**, that proposal must comply with—

- (a) *Performance Requirement P2.2.1*; and
- (b) the relevant *Performance Requirements* determined in accordance with **1.0.10**.

A. Acceptable construction manuals

3.1.2.0

Performance Requirement P2.2.1 is satisfied for drainage if it is designed and constructed in accordance with one of the following:

- (a) AS/NZS 3500.3.
- (b) Section 5 of AS/NZS 3500.5.

B. Acceptable construction practice

3.1.2.1 Application

Compliance with this acceptable construction practice satisfies *Performance Requirement P2.2.1* for drainage of—

- (a) roofs in areas subject to 5 minute duration rainfall intensities of not more than 255 mm per hour over an *average recurrence interval* of 20 years (as per **Table 3.5.2.1**) where a drainage system is *required*; and
- (b) sub-soil areas where excessive soil moisture problems may occur; and
- (c) land adjoining and under buildings,

provided the stormwater drainage system otherwise complies with the acceptable construction manual.

Explanatory information:

1. The BCA does not require the installation of drainage systems. Accordingly these requirements need only be applied when these systems are used.
2. Information on the need for drainage systems may be obtained from the *appropriate authority*.

SITE PREPARATION

3. The legal discharge point from a building *site* is generally determined by local government authorities.

3.1.2.2 Drainage requirements

Drainage systems must be installed as follows—

- (a) areas adjoining and under buildings — *surface water* drainage in accordance with 3.1.2.3; and
- (b) where *site* conditions exist that create a need for subsoil water to be diverted away from footings, basements, retaining walls etc — sub-soil drainage in accordance with 3.1.2.4; and
- (c) where underground drainage from roof areas is *required* or permitted — underground stormwater drainage in accordance with 3.1.2.5; and
- (d) excavation for drains adjacent to existing footings must be within the area described in **Figure 3.1.2.1** as being safe for excavation.

Figure 3.1.2.1

EXCAVATION FOR DRAINS ADJACENT TO FOOTINGS

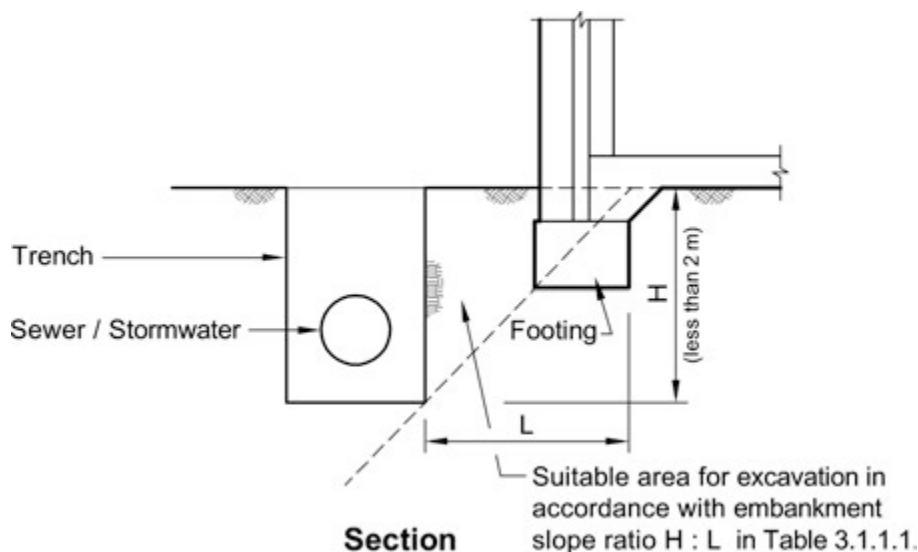

Note: Any excavation below the area defined as being safe for excavation will need additional protection measures to be determined by appropriately qualified persons.

3.1.2.3 Surface water drainage

Surface water must be diverted away from Class 1 buildings as follows:

- (a) Slab-on-ground — finished ground level adjacent to buildings:
 - (i) the external finished surface surrounding the slab must be drained to move *surface water* away from the building and graded to give a slope of not less than (see **Figure 3.1.2.2**)—
 - (i) 25 mm over the first 1 m from the building in *low rainfall intensity areas* for surfaces that are reasonably impermeable (such as concrete or clay paving); or

SITE PREPARATION

- (ii) 50 mm over the first 1 m from the building in any other case.
- (b) Slab-on-ground — finished slab heights:
- the height of the slab-on-ground above external finished surfaces must be not less than (see [Figure 3.1.2.2](#))—
- (i) 100 mm above the finished ground level in *low rainfall intensity areas* or sandy, well-drained areas; or
 - (ii) 50 mm above impermeable (paved or concreted areas) that slope away from the building in accordance with (a); or
 - (iii) 150 mm in any other case.

Explanatory information:

The appropriate slab height above finished ground level and the slope of the external finished surface surrounding the slab may vary depending on:

1. The local plumbing requirements; in particular the height of the overflow relief gully relative to drainage fittings and ground level (to work effectively they must be a minimum of 150 mm below the lowest sanitary fixture).
 2. The run-off from storms, particularly in areas of high rainfall intensity, and the local topography.
 3. The effect of excavation on a cut and fill *site*.
 4. The possibility of flooding.
 5. Termite risk management provisions.
- (c) The ground beneath suspended floors must be graded so that the area beneath the building is above the adjacent external finished ground level and *surface water* is prevented from ponding under the building (see [Figure 3.1.2.3](#)).

Figure 3.1.2.2

SITE SURFACE DRAINAGE

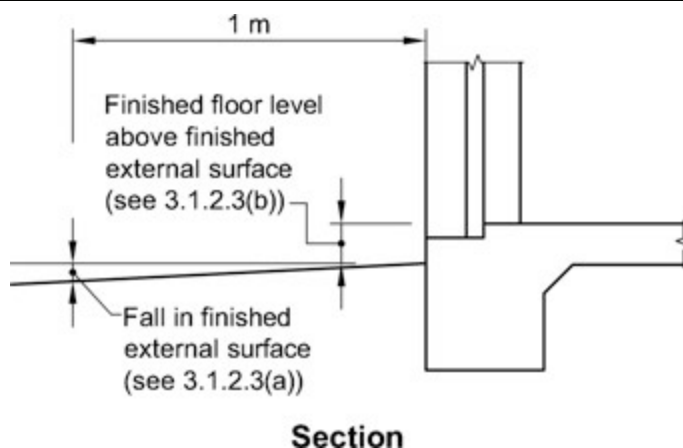

SITE PREPARATION

Figure 3.1.2.3

GRADING OF GROUND UNDER SUSPENDED FLOORS

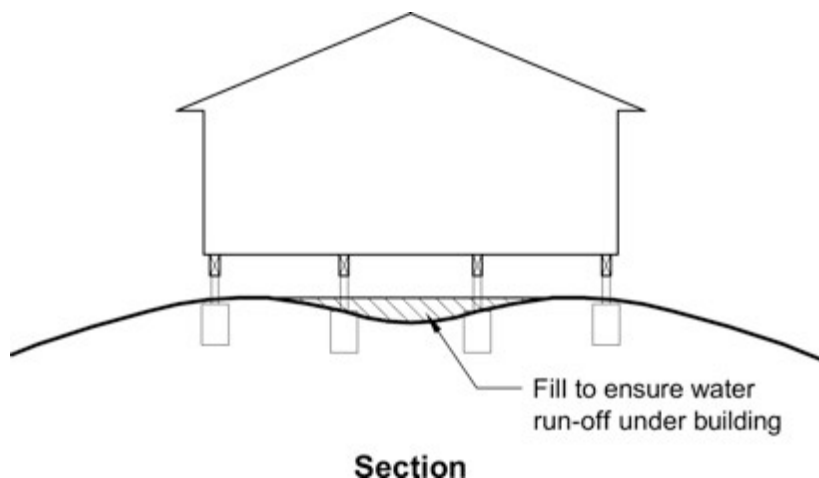

3.1.2.4 Subsoil drainage

Where a subsoil drainage system is installed to divert subsurface water away from the area beneath a building, the subsoil drain must—

- (a) be graded with a uniform fall of not less than 1:300; and
- (b) discharge into an external silt pit or sump with—
 - (i) the level of discharge from the silt pit or sump into an impervious drainage line not less than 50 mm below the invert level of the inlet (see [Figure 3.1.2.4](#)); and
 - (ii) provision for cleaning and maintenance.

Figure 3.1.2.4

CONSTRUCTION OF SILT PITS

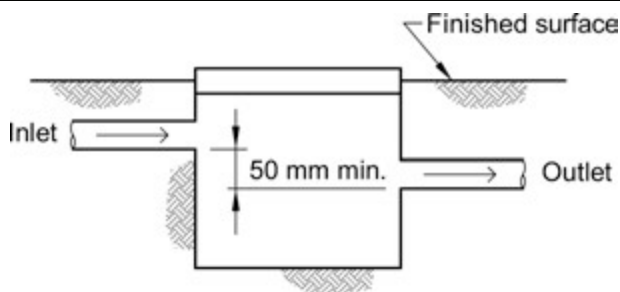

Explanatory information:

Subsoil drainage systems may need to be installed where subsurface water movement could damage buildings or cause loss of amenity through the build up of excessive moisture or lateral water pressure. Typical locations of subsoil drainage systems are on the uphill side of cut and fill sites, adjacent to deep footings, behind retaining walls and adjacent to basement walls.

SITE PREPARATION

The design and installation of subsoil drainage systems should take into account the nature of the soil and the anticipated water level, quantity and movement. In some cases, detailed investigations involving excavations, field observations and soil tests may be necessary to determine the appropriate solution. Typical subsoil drain configurations are shown in the following diagrams.

In clay soil, subsoil drains can alter the long-term moisture content in the soil, adversely affecting the building foundation by removing or, in some cases, introducing water. In such conditions, subsoil drains should only be used where there are no other options for dealing with subsoil water.

Additional guidance on subsoil drainage systems can be found in AS/NZS 3500.3, AS/NZS 3500.5 and AS 2870.

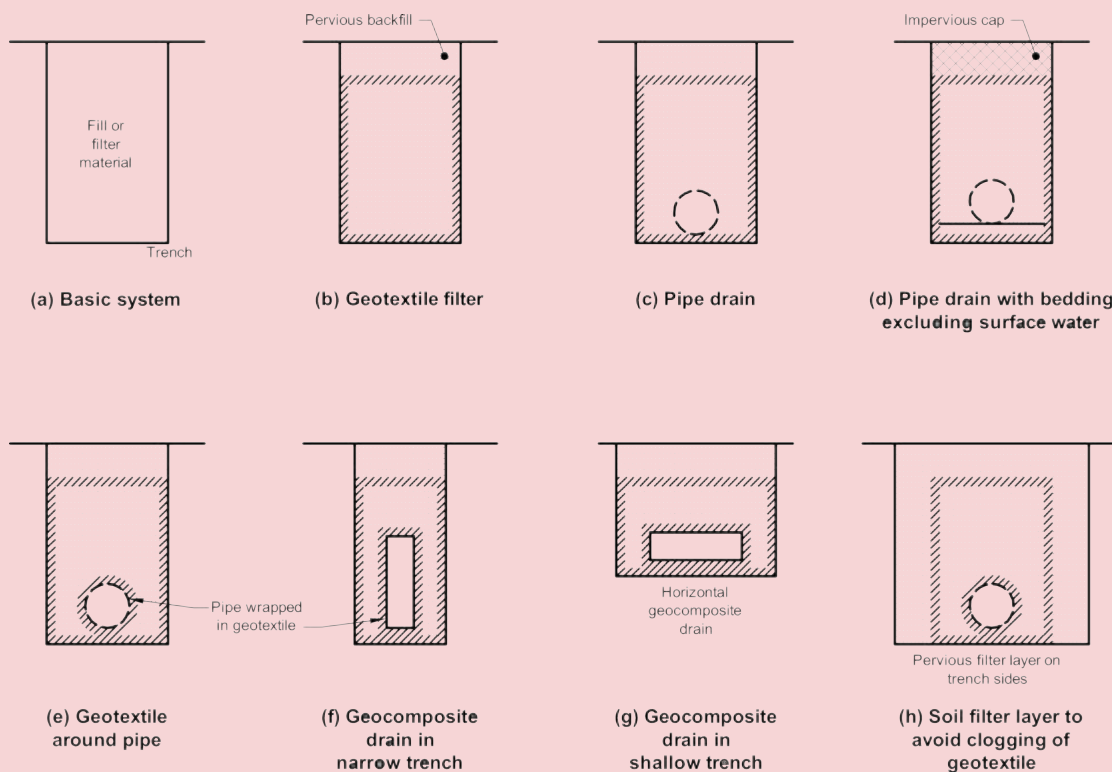

3.1.2.5 Stormwater drainage

Where a stormwater drainage system is installed, it must comply with the following:

- (a) The position and manner of discharge of the stormwater drainage system must be to the satisfaction of the *appropriate authority*.
- (b) The stormwater drainage system must be designed so that any overflow during heavy rain periods is prevented from flowing back into the building.

Explanatory information:

The manner of discharge of stormwater drainage systems includes consideration of discharge points. Some examples of discharge points which may be acceptable to the *appropriate authority* are:

SITE PREPARATION

- (a) A legal discharge point at the allotment boundary.
 - (b) On-site catchment systems, such as stormwater tanks.
 - (c) On-site soil drainage systems, such as soaker wells.
- (c) Cover to stormwater drains:
- the cover to 90 mm Class 6 UPVC stormwater drains installed underground must be not less than—
- (i) under soil — 100 mm; or
 - (ii) under paved or concrete areas — 50 mm; or
 - (iii) under areas subject to light vehicle traffic—
 - (A) reinforced concrete — 75 mm; or
 - (B) paved — 100 mm.

Explanatory information:

Different depths of soil cover (or no cover at all) can be achieved using other types of pipes. The cover specified is measured from the top of the pipe to either the finished ground level or, in the case of paved or concreted areas, to the underside of the paving or concrete.

PART 3.1.3 TERMITE RISK MANAGEMENT

Appropriate *Performance Requirements*:

Where an alternative termite management system is proposed as an *Alternative Solution* to that described in **Part 3.1.3**, that proposal must comply with—

- (a) *Performance Requirement P2.1.1*; and
- (b) the relevant *Performance Requirements* determined in accordance with **1.0.10**.

Definitions

3.1

The following definitions are used in this Part:

Primary building element means a member of a building designed specifically to take part of the building loads and includes roof, ceiling, floor, stairway or ramp and wall framing members including bracing members designed for the specific purpose of acting as a brace to those members.

Explanatory information:

The loads to which a building may be subjected are dead, live, wind, snow and earthquake loads. Further information on building loads can be found in the 1170 series of Standards.

STATE AND TERRITORY VARIATIONS

In Queensland delete definition of primary building element and replace with the following:

Primary building element means—

- (a) a member of a building designed specially to take part of the building loads and includes roof, ceiling, floor, stairway or ramp and wall framing members including bracing members designed for the specific purpose of acting as a brace to those members; and
- (b) door jambs, window frames and reveals, architraves and skirtings.

3.1.3 Application of this Part

- (a) The requirements of this Part apply when a *primary building element* of a Class 1 and 10 building is considered susceptible to termite attack.
- (b) This Part does not apply to Class 1 and 10 buildings as follows (see also **Figure 3.1.3.1**):
 - (i) Buildings in areas where subterranean termites are not known to present a potential risk of attack to the *primary building elements* of the building.

SITE PREPARATION

Explanatory information:

Termites are not considered to be a risk in Tasmania and a lesser risk in parts of Victoria. The *appropriate authority* may have records of termite activity for each area and may be able to advise you on whether termite risk management is needed.

- (ii) Buildings that have all their *primary building elements* constructed of one, or a combination of, the following materials:
 - (A) Steel, aluminium or other metals.
 - (B) Concrete.
 - (C) Masonry.
 - (D) Fibre-reinforced cement.
 - (E) Naturally termite resistant timber in accordance with Appendix C of AS 3660.1.
 - (F) Preservative treated timber in accordance with Appendix D of AS 3660.1.
- (iii) Buildings in Tasmania.

Explanatory information:

Where individual *primary building elements* are susceptible to termite attack and the remainder of the *primary building elements* are constructed of termite resistant materials, only the susceptible elements need to be provided with a termite management system.

STATE AND TERRITORY VARIATIONS

3.1.3(b)(ii)(E) is replaced by the following clause in the Northern Territory:

(E) Naturally termite resistant timber in accordance with Appendix C of AS 3660.1 in areas where *Mastotermes darwiniensis* are not prevalent.

SITE PREPARATION

Figure 3.1.3.1

FLOW CHART FOR IDENTIFYING IF A TERMITE MANAGEMENT SYSTEM IS REQUIRED

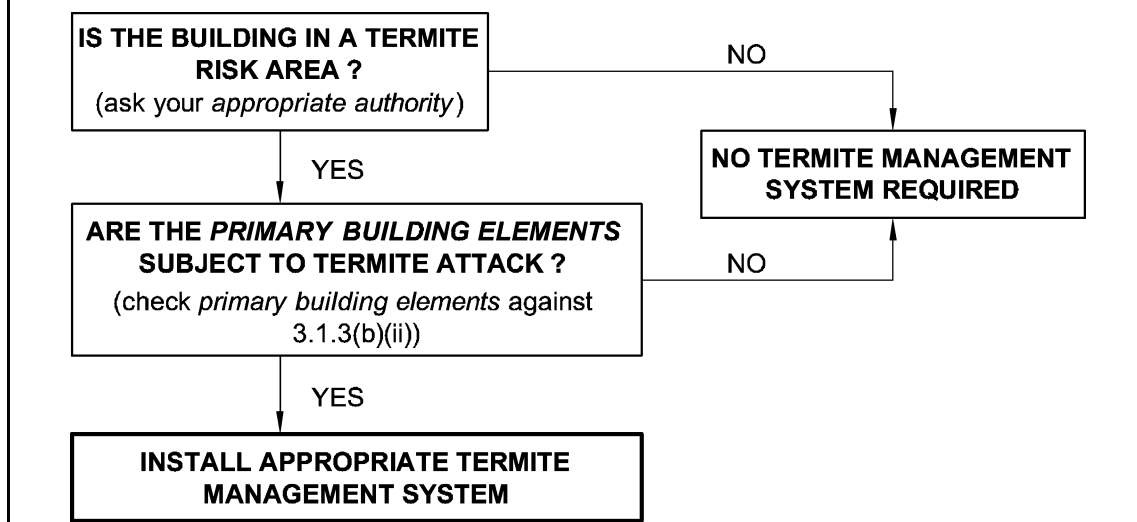

A. Acceptable construction manual

3.1.3.0 Acceptable construction manual

Performance Requirement P2.1.1 is satisfied for termite risk management if—

- a termite management system is installed in a Class 1 or 10 building to minimise the risk of termite attack to *primary building elements* in accordance with AS 3660.1; and
- a durable notice is installed in accordance with 3.1.3.2(b); and
- where a chemical termite management system is used, the chemical must be included on the *appropriate authority's* pesticides register.

Explanatory information:

Appropriate Authority

For the purpose of the pesticides register, the *appropriate authority* is the government body responsible for the registration of pesticides. Currently, the Australian Pesticides and Veterinary Medicines Authority (APVMA) coordinates the registration scheme.

STATE AND TERRITORY VARIATIONS

In the Northern Territory delete 3.1.3.0(c) and insert 3.1.3.0(c) and (d) as follows:

3.1.3.0 Acceptable construction manual

SITE PREPARATION

- (c) where a chemical termite management system is used, the chemical must be included on the *appropriate authority's* pesticides register; and
- (d) additional termite risk management measures are used in areas where *Mastotermes darwiniensis* are prevalent.

STATE AND TERRITORY VARIATIONS

In Queensland delete 3.1.3.0 and replace with the following:

3.1.3.0 Acceptable construction manual

Performance Requirements P2.1.1 and *P2.1.3* are satisfied for termite risk management if—

- (a) a termite management system is installed in a Class 1 or 10 building to minimise the risk of termite attack to *primary building elements* in accordance with AS 3660.1; and
- (b) the termite management system required by (a) has—
 - (i) for a non temporary Class 1 building, a design life of at least 50 years; or
 - (ii) for other than a non-temporary Class 1 building, a design life of at least 50 years or the specified design life of the building, whichever is the lesser; and
- (c) a termite management system need not comply with (b) if it is easily and readily accessible for replenishment or replacement and is capable of being replenished or replaced; and
- (d) where a chemical is used as an external perimeter termite management system, it is—
 - (i) installed by excavating trenches, treating the exposed trench and backfilling the trench with treated material; and
 - (ii) covered by a concrete cover strip not less than 50 mm thick and 300 mm wide measured from the *external wall* of the building; and
- (e) durable notices are installed in accordance with **3.1.3.2(b)**.

B. Acceptable construction practice

3.1.3.1 Application

Compliance with this acceptable construction practice satisfies *Performance Requirement P2.1.1* for termite risk management.

Explanatory information:

The intent of these requirements is to provide for a termite management system that will ensure that termites will not enter a building by a concealed route. The installation of a termite management system will not stop termite activity from occurring on the *site*.

STATE AND TERRITORY VARIATIONS

In Queensland delete 3.1.3.1 and replace with the following:

3.1.3.1 Application

SITE PREPARATION

Compliance with this Part satisfies *Performance Requirements P2.1.1* and *P2.1.3* for termite risk management.

3.1.3.2 Installation of termite management systems

- (a) A termite management system must comply with the appropriate provisions described in [Table 3.1.3.1](#).
- (b) A durable notice must be permanently fixed to the building in a prominent location, such as in a meter box or the like, indicating—
 - (i) the termite management system used; and
 - (ii) the date of installation of the system; and
 - (iii) where a chemical is used, its life expectancy as listed on the *appropriate authority's* pesticides register label; and
 - (iv) the installer's or manufacturer's recommendations for the scope and frequency of future inspections for termite activity.

Explanatory information:

Durable notice

A durable notice must be fixed to the building in a prominent location advising the building occupants that the system should be inspected and maintained.

The notice should be clearly written, on a material that will not deteriorate or fade over time and be located in or near the meter box or similar location so that it can be easily seen and read by future owners of the building. Additional information may be included if desired by the person placing the notice.

STATE AND TERRITORY VARIATIONS

In Queensland delete 3.1.3.2 and replace with the following:

3.1.3.2 Installation of termite management systems

- (a) A termite management system must be installed in accordance with—
 - (i) AS 3660.1 subject to [Clause 3.1.3.0\(b\), \(c\) and \(d\)](#); or
 - (ii) [3.1.3.3](#) for concrete slabs-on-ground; or
 - (iii) [3.1.3.4](#) for suspended floors.(For termite management system options, see [Table 3.1.3.1](#))
- (b) At least 2 durable notices must be permanently fixed to the building in prominent locations, such as in a meter box and a kitchen cupboard or the like, indicating—
 - (i) the method of termite risk management; and
 - (ii) the date of installation of the termite management measure; and
 - (iii) where a chemical is used, its life expectancy as listed on the National Registration Authority label; and
 - (iv) the installer's or manufacturer's recommendations for the scope and frequency of future inspections for termite activity.

SITE PREPARATION

Explanatory information:

Durable notices

At least two durable notices must be fixed to the building in prominent locations advising the building occupants that the termite management measure should be inspected and maintained. The notices should be clearly written, on a material that will not deteriorate or fade over time and be located in or near the meter box and in a kitchen cupboard or similar location so that it can be easily seen and read by future owners of the building. Additional information may be included if desired by the person placing the notice.

STATE AND TERRITORY VARIATIONS

3.1.3.2(c) is added as follows in the Northern Territory:

3.1.3.2 Installation of termite management systems

- (c) when a chemical is used as an external perimeter termite management system for *Mastotermes darwiniensis*, it is—
- (i) installed by excavating trenches, treating the exposed trench and backfilling the trench with treated material; and
 - (ii) covered by a concrete cover strip not less than 50 mm thick and 300 mm wide measured from the external wall of the building.

Table 3.1.3.1 ACCEPTABLE TERMITE MANAGEMENT SYSTEMS AND COMPONENTS

Floor construction		Termite management system or component	Requirement
Concrete slab-on-ground	Slab perimeter	Slab edge exposure	3.1.3.3
		Sheet material	3.1.3.4
		Granular material	3.1.3.5
	Penetrations/control joints/area beneath the slab (see Note)	Chemical	3.1.3.6
		Sheet material	3.1.3.4
		Granular material	3.1.3.5
Suspended floors	Chemical	3.1.3.6	
	Sheet material	3.1.3.4	
	Granular material	3.1.3.5	
		Chemical	3.1.3.6

Note: The entire area beneath the slab must be treated when the slab-on-ground is not designed and constructed in accordance with AS 2870 or AS 3600.

Explanatory information:

1. Component

A “component” of a system as referred to in [Table 3.1.3.1](#) is one that when used in a combination with other components, will form a “full system”.

SITE PREPARATION

For example, if a concrete slab is used as a component of a system, it in itself will not provide a complete termite management system. Then, depending on the construction methods and the site conditions, additional requirements will be necessary for service penetrations. Each of these are “components”, yet when integrated, will form a “full system”.

In addition to the acceptable termite management systems and components described in [Table 3.1.3.1](#), other methods or systems can be used if it can be demonstrated that they meet the relevant *Performance Requirements* of the *Housing Provisions*. Forms of evidence of suitability are described in [Part 1.2](#) — Acceptance of design and construction.

The requirements in the BCA are minimum requirements and owners of buildings may choose to incorporate additional termite management systems in their buildings.

2. Integrity of the Termite Management System

There are more than 350 species of termites in Australia, about 30 of which achieve economic importance by causing costly damage to building structures. Due to the nature of termites, it is extremely difficult to prevent them gaining access to a building.

In addition to the correct installation of a termite management system, its effectiveness will rely on regular maintenance and competent inspection.

STATE AND TERRITORY VARIATIONS

In Queensland delete [Table 3.1.3.1](#) and replace with the following:

Table 3.1.3.1 ACCEPTABLE TERMITE MANAGEMENT SYSTEMS AND COMPONENTS

TERMITE MANAGEMENT SYSTEM OR COMPONENT (as per AS 3660.1)	FOOTING SYSTEM				
	Concrete slab-on-ground complying with AS 2870		Concrete slab-on-ground not complying with AS 2870		Suspended floors
	Penetrations and control joints	Slab perimeter	Beneath slab (includes penetrations and control joints)	Slab perimeter	
Slab edge exposure	Not suitable	Suitable subject to 3.1.3.0(b)	Not suitable	Suitable subject to 3.1.3.0(b)	Not applicable
Termite shielding	Not suitable	Not suitable	Not suitable	Not suitable	Suitable subject to 3.1.3.0(b)
Stainless steel mesh	Component; or full system subject to 3.1.3.0(b)	Component; or full system subject to 3.1.3.0(b)	Full system subject to 3.1.3.0(b)	Full system subject to 3.1.3.0(b)	Suitable subject to 3.1.3.0(b)
Graded stone	Component; or full system subject to 3.1.3.0(b)	Component; or full system subject to 3.1.3.0(b)	Full system subject to 3.1.3.0(b)	Full system subject to 3.1.3.0(b)	Component; or full system subject to 3.1.3.0(b)

SITE PREPARATION

Table 3.1.3.1 ACCEPTABLE TERMITE MANAGEMENT SYSTEMS AND COMPONENTS — continued

TERMITE MANAGEMENT SYSTEM OR COMPONENT (as per AS 3660.1)	FOOTING SYSTEM				
	Concrete slab-on-ground complying with AS 2870		Concrete slab-on-ground not complying with AS 2870		Suspended floors
	Penetrations and control joints	Slab perimeter	Beneath slab (includes penetrations and control joints)	Slab perimeter	
Chemicals	Full system beneath slab subject to 3.1.3.0(b) and (c)	Perimeter system subject to 3.1.3.0(b) and (d)	Full system beneath slab subject to 3.1.3.0(b) and (c)	Perimeter system subject to 3.1.3.0(b) and (d)	Full system subject to 3.1.3.0(b) and (c)

3.1.3.3 Concrete slab-on-ground edge exposure

The edge of a slab-on-ground may be used as a perimeter component of a termite management system provided—

- (a) the slab edge is left exposed, not less than 75 mm above finished ground level; and
- (b) the face of the exposed edge is not rough or honeycombed and does not contain ripples caused by folds in the vapour barrier or the like that could conceal termite activity; and
- (c) the exposed surface is not rendered, tiled, clad or concealed by *flashing*.

Explanatory information:

1. The slab as a component of a termite management system

A concrete slab, designed and constructed in accordance with AS 2870 or AS 3600, can form part of an acceptable termite management system. Cracking of the slab is common and does not necessarily indicate the failure of the component. Most cracks, including those that may appear quite wide on the surface do not necessarily extend for the full depth of the slab.

2. Slab edge exposure

This approach is similar to that applied to sheet material in that termite activity is forced onto the exposed edge of the slab where with regular inspections termite ingress via the perimeter of the building can be detected.

The exposed edge of the slab should be kept clean. Debris such as leaves should be removed to ensure the full 75 mm of the slab is always visible.

3.1.3.4 Sheet materials

- (a) Sheet material must—
 - (i) comply with AS 3660.1; or
 - (ii) for a suspended floor—
 - (A) be Z275 galvanised steel with a minimum thickness of 0.5 mm; and
 - (B) extend the entire width of an external or internal foundation wall, and—

SITE PREPARATION

- (aa) the sheet must extend not less than 40 mm from the vertical face of the wall and be turned down 45° from the horizontal; except
 - (bb) for an *external wall* the sheet can terminate at the outside face of the wall; and
 - (cc) if a render is used on an *external wall*, the sheet must finish flush with the outside face of the render; and
 - (C) fully cover piers or posts and extend not less than 40 mm from the vertical face of the piers or post with the sheet turned down at 45° from the horizontal; and
 - (D) have an unobstructed clearance from connections, services, ties and the like of not less than 25 mm; and
 - (E) comply with AS 3660.1 for joints in the sheet material.
- (b) The area beneath a suspended floor of a building must—
- (i) be provided with sub-floor ventilation in accordance with **Part 3.4.1**; and
 - (ii) for a suspended floor covered by (a)(ii), have a minimum clearance between the finished ground level and any structural elements or obstructions of 400 mm, except on sloping *sites* the 400 mm clearance may be reduced to 150 mm within 2 m of *external walls* in accordance with **Figure 3.4.1 Diagram b**.

Explanatory information:

Treatment of sub-floor areas

The area beneath a building requires special attention to ensure the effectiveness of the termite management system. The following points should be observed:

- a. Sub-floor ventilation — In suspended floor areas it is important that termite activity is not encouraged by inadequate subfloor ventilation. In conjunction with physical or chemical termite management systems air flow is critical. Air flow will not only restrict the growth of fungus which attacks subfloor members (which makes them more susceptible to termite attack), but also creates a climatic atmosphere less conducive to termite activity.
- b. Subfloor access — Sheet material installed below suspended floors relies on access for both inspection and maintenance to be effective. Accordingly, minimum clearance heights will need to be achieved between the building structure (including ducts) and the ground to allow easy access to all areas where sheet materials are used.

Perimeter access doors will also be needed where access is required for inspection and maintenance.

3.1.3.5 Granular material

A granular material termite management system must comply with AS 3660.1.

3.1.3.6 Chemical

A chemical termite management system must—

- (a) be listed on the *appropriate authority's* pesticides register; and
- (b) comply with—
 - (i) AS 3660.1; or

SITE PREPARATION

- (ii) have been tested and passed the tests required by Section 5 of AS 3660.3.

Explanatory information:

3.1.3.6(b)(ii) provides the option of having a chemical termite management system tested to AS 3660.3. In order for the test results to remain valid, the system would then have to be installed as tested.

3.1.3.7 Attachments to buildings

- (a) Attachments to buildings such as downpipes and service pipes must have a gap to allow clear and uninterrupted visual inspection across the inspection zone.
- (b) Structures such as steps, verandahs, porches, access ramps, carports, trellises, decks, heated water systems, airconditioners, or the like which are not provided with one of the termite management systems described in this Part, must be separated from the building by a gap of not less than 25 mm, to allow clear and uninterrupted visual inspection across the inspection zone.
- (c) Where attachments or structures, as outlined in (a) and (b), abut a building and there is no clear gap, a termite management system must be provided to the attachment, regardless of the size of the attachment.
- (d) For the purposes of this clause, an inspection zone is an unobstructed space which termites must cross or pass in order to gain access to a building or structure and, as a consequence, reveal their presence during visual inspection.

PART **3.2**

FOOTINGS AND SLABS

- 3.2 Footings and Slabs**
- 3.2.2 Preparation**
- 3.2.3 Concrete and Reinforcing**
- 3.2.4 Site Classification**
- 3.2.5 Footing and Slab Construction**

PART 3.2 CONTENTS

PART 3.2 FOOTINGS AND SLABS

Explanatory Information

3.2 Footings and Slabs

3.2 Definitions

3.2.0 Acceptable construction manuals

3.2.1 Application

3.2.2 Preparation

3.2.2.1 Excavation for footings

3.2.2.2 Filling under concrete slabs

3.2.2.3 Foundations for footings and slabs

3.2.2.4 Slab edge support on sloping sites

3.2.2.5 Stepped footings

3.2.2.6 Vapour barriers

3.2.2.7 Edge rebates

3.2.3 Concrete and Reinforcing

3.2.3.1 Concrete

3.2.3.2 Steel reinforcement

3.2.4 Site Classification

3.2.4.1 Site classification

3.2.5 Footing and Slab Construction

3.2.5.1 Footing and slab construction

3.2.5.2 Footings and slabs to extensions to existing buildings

3.2.5.3 Shrinkage control

3.2.5.4 Minimum edge beam dimensions

3.2.5.5 Footings for fireplaces on Class A and S sites

3.2.5.6 Stump footing details

PART 3.2

EXPLANATORY INFORMATION

Explanatory information:

This Part specifies the requirements for the excavation and filling for the footing or slab together with the construction of various alternative concrete slab and footing configurations. The slab and footing configurations detailed in [Part 3.2.5](#) are only suitable for the specified soil classifications. The requirements contained in the remainder of this Part are more general and may be applied to all slab and footing construction.

PART 3.2 FOOTINGS AND SLABS

Appropriate *Performance Requirements*:

Where an alternative footing system is proposed as an *Alternative Solution* to that described in **Part 3.2**, that proposal must comply with—

- (a) *Performance Requirement P2.1.1*; and
- (b) *Performance Requirement P2.2.3*; and
- (c) the relevant *Performance Requirements* determined in accordance with **1.0.10**.

Definitions

3.2

The following definitions are used in this Part:

Articulated masonry means masonry construction in which special provisions have been made for movement by articulation.

Clad frame means timber or metal frame construction with exterior timber or sheet wall cladding that is not sensitive to minor movement and includes substructure masonry walls up to 1.5 m high.

Controlled fill means material that has been placed and compacted in layers with compaction equipment (such as a vibrating plate) within a defined moisture range to a defined density requirement.

Finished ground level means the ground level adjacent to footing systems at the completion of construction and landscaping.

Footing means construction that transfers the load from the building to the *foundation*.

Loadbearing wall, for the purposes of this Part, means any wall imposing on the footing a load greater than 10 kN/m.

Mixed construction means a building consisting of more than one form of construction, particularly in double-storey buildings.

Rolled fill means material placed in layers and compacted by repeated rolling by an excavator.

Single leaf masonry means outer walls constructed with a single thickness of masonry unit.

Waffle raft means a stiffened raft with closely spaced ribs constructed on the ground and with slab panels supported between ribs.

A. Acceptable construction manuals

3.2.0

Performance Requirements P2.1.1 and *P2.2.3* are satisfied for footings and slabs if they are installed in accordance with one of the following:

- (a) The footing or slab is constructed in accordance with AS 2870.
- (b) Piled footings are designed in accordance with AS 2159.

Explanatory information:

Composite construction — design requirements for other materials that may be used in combination with the above footing systems, including the use of heavy steel support beams etc are described in [Part 3.11](#) — structural design codes.

STATE AND TERRITORY VARIATIONS

In New South Wales delete 3.2.0(a) and insert NSW 3.2.0(a) as follows:

- (a) The footing or slab is constructed in accordance with AS 2870 except that for the purposes of Clause 5.3.3.1 of AS 2870 a damp-proofing membrane is required to be provided.

B. Acceptable construction practice

3.2.1 Application

Compliance with the acceptable construction practice contained in Parts [3.2.2](#) to [3.2.5](#) satisfies *Performance Requirements P2.1.1* and *P2.2.3* for footings and slabs, provided—

- (a) the footing is on a Class A, S, M, M-D, H or H-D *site* (classified in accordance with AS 2870) with a uniform bearing capacity; and
- (b) the slab is not more than 30 m long; and
- (c) slabs containing permanent joints (eg construction joints) are not used; and
- (d) the structure supported by the footing does not contain—
 - (i) more than two trafficable floors; or
 - (ii) a wall height exceeding 8 m, excluding any gable; and
- (e) the footing does not support more than one concrete slab; and

Explanatory information:

For the purpose of [\(e\)](#) split level slabs are considered as one slab.

FOOTINGS AND SLABS

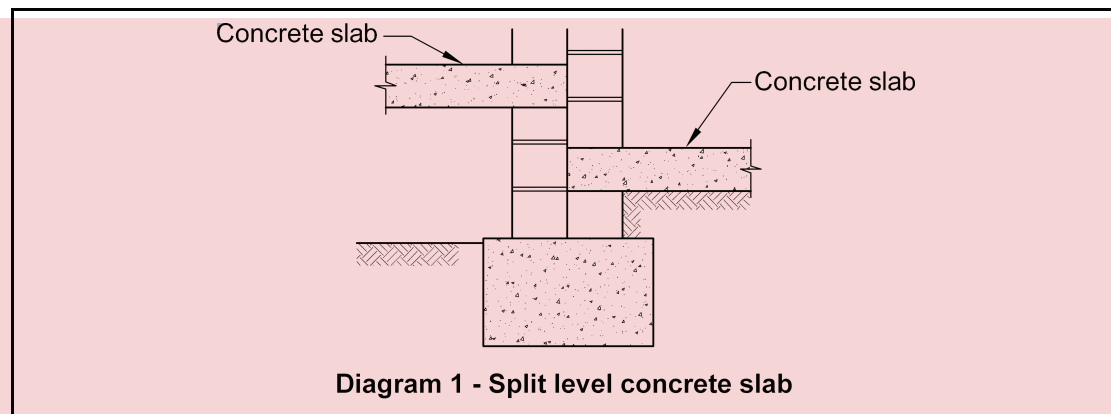

- (f) the building does not include wing walls or masonry arches not detailed for movement in accordance with Cement Concrete and Aggregates Australia TN 61; and
- (g) single leaf earth or stone masonry walls do not exceed 3 m in height; and
- (h) the *site* is considered to be normal as defined in **Part 3.1.1**; and
- (i) the *site* is not located in an *alpine area*.

PART 3.2.2 PREPARATION

3.2.2.1 Excavation for footings

- (a) Excavation for footings, including thickenings for slabs and pads must be clean cut with vertical sides, wherever possible.
- (b) The base of the excavation must be—
 - (i) for flat *sites*, generally level but may slope not more than 1:40 to allow excavations to drain; and
 - (ii) sloping *sites* at an angle of not more than 1:10; and
 - (iii) stepped footings in accordance with **3.2.2.5**.
- (c) Footing excavations must be free of loose earth, tree roots, mud or debris immediately before pouring concrete.
- (d) Topsoil containing grass roots must be removed from the area on which the footing will rest.
- (e) Excavation depths and soil cuts must comply with **Part 3.1.1**.

STATE AND TERRITORY VARIATIONS

3.2.2.1(e) does not apply in New South Wales.

Note: In New South Wales requirements for shoring and adequacy of excavation works are a prescribed condition of development consent. In addition consent authorities can place specific controls on siteworks associated with the construction of a building, by imposing further conditions of development consent. Information addressing siteworks can be found in the Department of Planning and Environment – Act and Regulation note "Health, safety and amenity during construction".

- (f) On loose sand *sites* or *sites* subject to wind or water erosion, the depth below *finished ground level* for footings must be not less than 300 mm.
- (g) Height of finished slab-on-ground must be in accordance with **3.1.2.3(b)**.

3.2.2.2 Filling under concrete slabs

Filling placed under a slab (except where the slab is suspended) must comply with the following:

- (a) Filling must be either *controlled fill* or *rolled fill* as follows:
 - (i) Sand used in *controlled fill* or *rolled fill* must not contain any gravel size material and achieve a blow count of 7 or more per 300 mm using the test method described in AS 1289, Method 6.3.3.
 - (ii) Clay used in *controlled fill* or *rolled fill* must be moist during compaction.
 - (iii) *Controlled fill*:
 - (A) Sand fill up to 800 mm deep — well compacted in layers not more than 300 mm deep by vibrating plate or vibrating roller.

FOOTINGS AND SLABS

- (B) Clay fill up to 400 mm deep — well compacted in layers of not more than 150 mm by a mechanical roller.
- (iv) *Rolled fill*:
 - (A) Sand fill up to 600 mm deep — compacted in layers of not more than 300 mm by repeated rolling by an excavator or other suitable mechanical equipment.
 - (B) Clay fill up to 300 mm deep — compacted in layers of not more than 150 mm by repeated rolling by an excavator or similar machine.
- (b) * * * * *
- (c) A level layer of clean quarry sand must be placed on top of the fill, with a depth of not less than 20 mm.
- (d) A graded stone termite management system complying with **Part 3.1.3** may be substituted for the sand required in (c).

3.2.2.3 Foundations for footings and slabs

Footings and slabs, including internal and edge beams, must be founded on soil with an allowable bearing pressure as follows:

- (a) Slab panels, load support panels and internal beams — natural soil with an allowable bearing pressure of not less than 50 kPa or *controlled fill* or *rolled fill* compacted in accordance with **3.2.2.2**.
- (b) Edge beams connected to the slab — natural soil with an allowable bearing pressure of not less than 50 kPa or *controlled fill* compacted in accordance with **3.2.2.2(a)(iii)** and extending past the perimeter of the building 1 m with a slope ratio not steeper than 2 horizontal to 1 vertical (see **Figure 3.2.2.1**).
- (c) Pad footings, strip footings and edge beams not connected to the slab, must be—
 - (i) founded in natural soil with an allowable bearing pressure of not less than 100 kPa; or
 - (ii) for Class A and S *sites* they may be founded on controlled sand fill in accordance with **3.2.2.2(a)**.

3.2.2.4 Slab edge support on sloping sites

Footings and slabs installed on the low side of sloping *sites* must be as follows:

- (a) Slab panels — in accordance with **3.2.2.3(a)**.
- (b) Edge beams—
 - (i) supported by *controlled fill* in accordance with **3.2.2.3(b)** (see **Figure 3.2.2.1**, Option 1); or
 - (ii) supported by deepened edge beams or bulk piers designed in accordance with AS 3600 (see **Figure 3.2.2.1**, Option 2); or
 - (iii) deepened (as per AS 2870) to extend into the natural soil level with a bearing capacity in accordance with **3.2.2.3(b)** (see **Figure 3.2.2.1**, Option 3); or
 - (iv) stepped in accordance with AS 2870.
- (c) Edge beams not connected to the slab, pad footings and strip footings — founded in accordance with **3.2.2.3(c)**.

FOOTINGS AND SLABS

- (d) Where an excavation (cut) of the natural ground is used it must be in accordance with [Part 3.1.1](#).

Figure 3.2.2.1

SLAB EDGE SUPPORT ON THE LOW SIDE OF SLOPING SITES

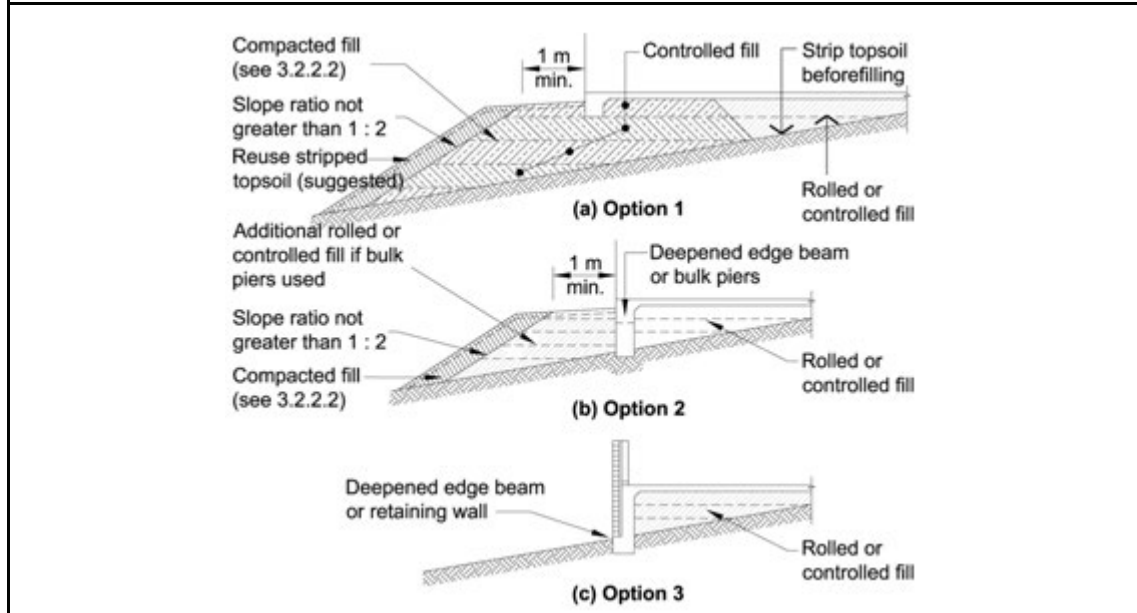

Explanatory information:

The *foundations* of a building are critical to its successful performance. As such, the soil must have the strength or bearing capacity to carry the building load with minimum movement.

The bearing capacity of a soil varies considerably and needs to be determined on a *site* by *site* basis. For this to occur, the appropriate people need to be consulted. These people may include a qualified engineer or experienced engineering geologist, or it may be determined by a person with appropriate local knowledge. The minimum bearing capacity (soil strength rating) may depend on the *site* conditions. The soil may be naturally undisturbed or be disturbed by building work or the like. Where soil is disturbed by building work and the like, the bearing capacity can be dramatically altered. This is typically the case for sloping *sites* where cut and fill procedures are used. In these situations the soil needs to be consolidated, generally via compaction, to achieve the *required* bearing capacity.

There are a number of alternatives for working on cut and filled sites. These are described in [Figure 3.2.2.1](#).

Option 1 of [Figure 3.2.2.1](#) refers to the controlled fill process which involves the compaction of fill in layers to achieve the bearing capacity described in [3.2.2.3](#). The depth of fill for each layer is specified to ensure effective compaction. Fill beyond these depths will need to be installed in accordance with the acceptable construction manuals set out in [3.2.0](#).

Option 2 and 3 of [Figure 3.2.2.1](#) refer to edge beams that extend through the fill into undisturbed soil which provides the [3.2.2.3](#) *required* bearing capacity. In this situation the fill is essentially only taking the internal slab loads.

FOOTINGS AND SLABS

3.2.2.5 Stepped footings

Stepped strip footings must be constructed as follows—

- (a) the base of the footing must be horizontal or have a slope of not more than 1:10; or
- (b) be stepped in accordance with one of the methods shown in [Figure 3.2.2.2](#).

Figure 3.2.2.2

STEPPED STRIP FOOTINGS

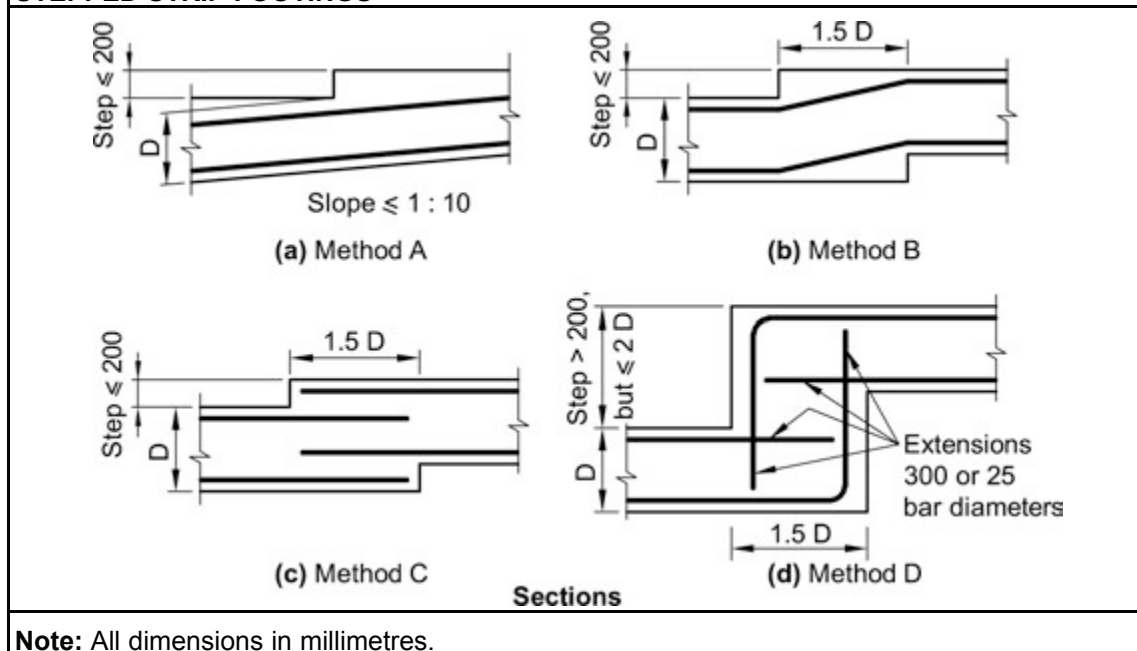

3.2.2.6 Vapour barriers

A vapour barrier must be installed under slab-on-ground construction for all Class 1 buildings and for Class 10 buildings where the slab is continuous with the slab of a Class 1 building as follows—

- (a) Materials

A vapour barrier must be—

- (i) 0.2 mm nominal thickness polyethylene film; and
- (ii) medium impact resistant,

determined in accordance with criteria specified in clause 5.3.3.3 of AS 2870; and

- (iii) be branded continuously “AS 2870 Concrete underlay, 0.2 mm Medium impact resistance”.

- (b) Installation

A vapour barrier must be installed as follows—

- (i) lap not less than 200 mm at all joints; and
- (ii) tape or seal with a close fitting sleeve around all service penetrations; and

FOOTINGS AND SLABS

- (iii) fully seal where punctured (unless for service penetrations) with additional polyethylene film and tape.
- (c) The vapour barrier must be placed beneath the slab so that the bottom surface of the slab is entirely underlaid and extends under edge beams to finish at ground level in accordance with [Figure 3.2.2.3](#).

STATE AND TERRITORY VARIATIONS

In New South Wales delete 3.2.2.6 and insert NSW 3.2.2.6 as follows:

NSW 3.2.2.6 Damp-proofing membrane

A damp-proofing membrane must be installed under slab-on-ground construction for all Class 1 buildings and for Class 10 buildings where the slab is continuous with the slab of a Class 1 building as follows—

(a) Materials

A damp-proofing membrane must be—

- (i) 0.2 mm nominal thickness polyethylene film; and
- (ii) high impact resistant, determined in accordance with criteria specified in clause 5.3.3.3 of AS 2870; and
- (iii) be branded continuously "AS 2870 Concrete underlay, 0.2 mm High impact resistance".

(b) Installation

A damp-proofing membrane must be installed as follows—

- (i) lap not less than 200 mm at all joints; and
- (ii) tape or seal with a close fitting sleeve around all service penetrations; and
- (iii) fully seal where punctured (unless for service penetrations) with additional polyethylene film and tape.

- (c) The damp-proofing membrane must be placed beneath the slab so that the bottom surface of the slab is entirely underlaid and extends under edge beams to finish at ground level in accordance with [Figure 3.2.2.3](#).

Note: A range of polyethylene films can be used, including black film and orange film, provided they satisfy the requirements for high impact resistance in accordance with the criteria specified in clause 5.3.3.3 of AS 2870.

In South Australia delete 3.2.2.6 and insert SA 3.2.2.6 as follows:

SA 3.2.2.6 Damp-proofing membrane

A continuous damp-proofing membrane must be installed under slab-on-ground construction for all Class 1 buildings and for Class 10 buildings where the slab is continuous with the slab of a Class 1 building as follows—

(a) Materials

A damp-proofing membrane must be—

- (i) 0.2 mm nominal thickness polyethylene film; and
- (ii) high impact resistant with resistance to puncturing and moisture penetration,

FOOTINGS AND SLABS

determined in accordance with criteria specified in clause 5.3.3.3 of AS 2870; and

(iii) be branded continuously “AS 2870 Concrete underlay, 0.2 mm High impact resistance” together with the manufacturer’s or distributor’s name, trade mark or code.

(b) Installation

A damp-proofing membrane must be installed as follows—

(i) lap not less than 200 mm at all joints; and

(ii) tape or seal with a close fitting sleeve around all service penetrations; and

(iii) fully seal where punctured (unless for service penetrations) with additional polyethylene film and tape.

(c) The damp-proofing membrane must be placed beneath the slab so that the bottom surface of the slab is entirely underlaid and extends under edge beams to finish at ground level in accordance with [Figure 3.2.2.3](#).

3.2.2.7 Edge rebates

Edge rebates for slab-on-ground, stiffened raft or *waffle raft* with masonry *cavity* or veneer construction must comply with the following:

(a) The rebate must not be less than 20 mm, except as provided for in (d).

(b) Exterior masonry must not overhang more than 15 mm past the edge of the slab.

(c) The edge rebate must be flashed and drained in accordance with [Part 3.3.4](#) and where it cannot be flashed it must be filled with mortar.

(d) Edge rebates are not *required* for *single leaf masonry*.

Explanatory information:

See [3.2.5.4](#) for minimum edge beam details.

FOOTINGS AND SLABS

Figure 3.2.2.3

ACCEPTABLE VAPOUR BARRIER AND DAMP-PROOFING MEMBRANE LOCATION

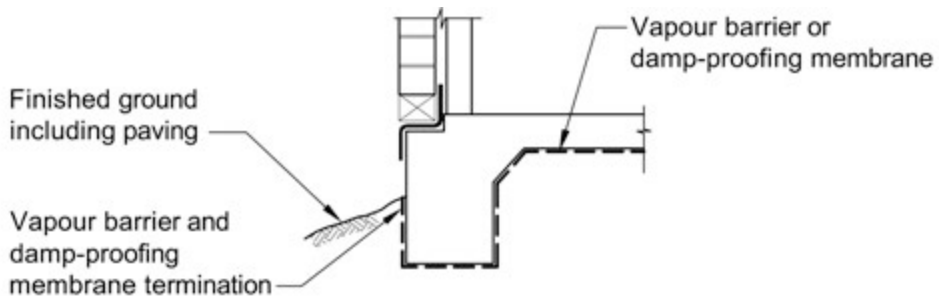

(a) Minimum rebate for cavity masonry or veneer wall

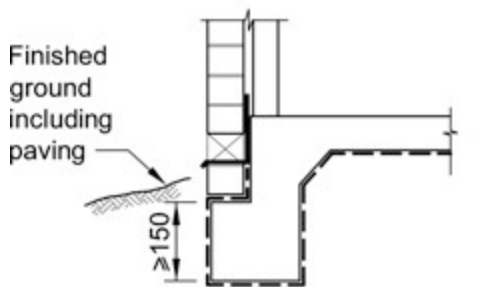

(b) Deep edge rebate alternative

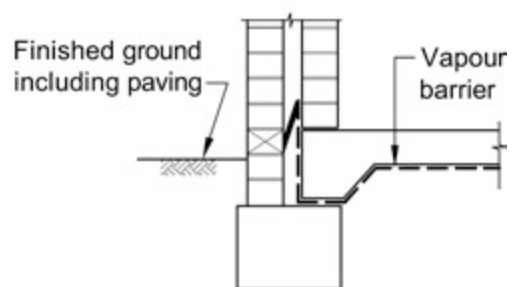

(c) Masonry alternative

Note: All dimensions in millimetres.

PART 3.2.3 CONCRETE AND REINFORCING

3.2.3.1 Concrete

Concrete must comply with the following:

- (a) Concrete must be manufactured to comply with AS 3600; and—
 - (i) have a strength at 28 days of not less than 20 MPa (denoted as N20 grade); and
 - (ii) have a 20 mm maximum nominal aggregate size; and
 - (iii) have a nominal 100 mm slump.
- (b) Water must not be added to the mix to increase the slump to a value in excess of that specified.
- (c) Concrete must be placed, compacted and cured in accordance with good building practice.

STATE AND TERRITORY VARIATIONS

In South Australia after 3.2.3.1(c) insert SA 3.2.3.1(d), (e), (f) and (g) as follows:

- (d) Concrete in slabs must be adequately compacted, and slab surfaces, including edges, moist cured for 7 days.
- (e) After vertical surfaces are stripped of formwork, slab edges must be finished prior to curing.
- (f) Loading of concrete slabs with stacked materials or building plant must not occur for a minimum of 7 days after pouring although construction of wall frames and setting out brickwork may be undertaken during this period.
- (g) Concrete must not be poured if the air temperature on *site* exceeds 32°C unless written instructions from a *professional engineer* are followed.

Explanatory information:

1. Complete discharge of the concrete from the truck should be made within one and a half hours of initial mixing with water unless a suitable retarder has been specified.
2. Compacting concrete by vibration removes air pockets and works the concrete thoroughly around reinforcement, service penetrations etc. and into corners of formwork to increase durability and resistance to termite infestation and salt damp attack. Care should be taken not to over-vibrate. The finishing and curing of slab edges provides an improved edge finish which is resistant to edge dampness.
3. Care should be taken when using chemical curing methods, because some products may not be compatible with adhesives used to fix surface finishes to the slab.

3.2.3.2 Steel reinforcement

- (a) Materials used for reinforcing steel must comply with AS 2870 and be—
 - (i) welded wire reinforcing fabric; or
 - (ii) trench mesh; or

FOOTINGS AND SLABS

- (iii) steel reinforcing bars.
- (b) Steel reinforcing bars may be substituted for trench mesh in accordance with [Table 3.2.3.2](#).

Explanatory information:

Reinforcement types referenced in this Part are described as follows:

1. Square mesh is designated in terms of the diameter of each bar and the spacing of consecutive bars. For example, SL62 consists of 6 mm bar at 200 mm spacings.
2. Trench mesh is designated in terms of the number of longitudinal bars and the diameter of each bar. For example, 3-L11TM consists of 3 longitudinal bars each of which are 11 mm in diameter.
3. Reinforcing bars are designated in terms of the number of bars and the diameter of each bar. For example, 6-N12 consists of 6 bars each of which are 12 mm in diameter.

- (c) Minimum laps for reinforcement as shown in [Table 3.2.3.1](#) and [Figure 3.2.3.1](#) must be provided where reinforcing is used.

Table 3.2.3.1 MINIMUM LAP FOR REINFORCEMENT

Reinforcement	Minimum splice (mm)	Minimum Lap at "T" intersections	Minimum Lap at "L" intersections
Steel reinforcing bars	500	Full width across the junction	One outer bar must be bent and continue 500 mm (min) around corner
Trench mesh	500	Full width across the junction	Full width across the junction
Square and Rectangular Mesh	The two outermost transverse wires of one sheet must overlap the two outermost transverse wires of the other	Not applicable	Not applicable

FOOTINGS AND SLABS

Figure 3.2.3.1

LAPS IN REINFORCEMENT

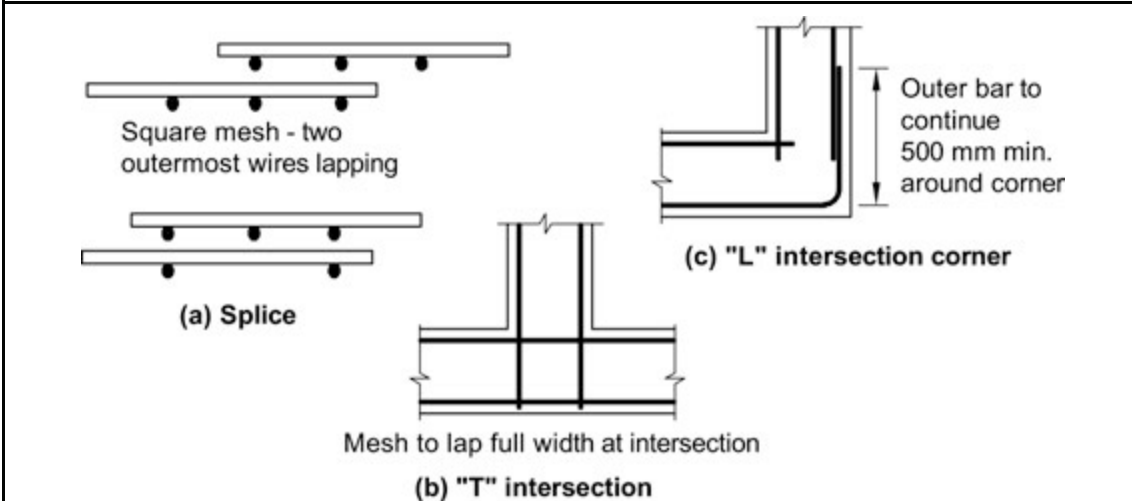

Table 3.2.3.2 ALTERNATIVE MESH/REINFORCING BAR SIZES

Trench mesh (TM)	Area — mm ²	Reinforcing bar alternative	Trench mesh alternative
2-L8TM	91	2-N10 or 1-N12	not applicable
3-L8TM	136	2-N10 or 2-N12	not applicable
4-L8TM	182	2-N12	2-L11TM
5-L8TM	227	2-N12	3-L11TM
2-L11TM	180	1-N16 or 2-N12	2x2-L8TM
3-L11TM	270	3-N12	2x3-L8TM
4-L11TM	360	2-N16	2x4-L8TM
2-L12TM	222	2-N12	3-L11TM
3-L12TM	333	3-N12	4-L11TM
4-L12TM	444	4-N12	5-L11TM

Notes:

1. Where necessary 2 layers of mesh may be used.
2. L11TM and L12TM may be replaced by RL1118 and RL1218 mesh respectively.
3. L11TM may be replaced by two layers of L8TM.

- (d) Footings and slabs-on-ground must have concrete cover between the outermost edge of the reinforcement (including ligatures, tie wire etc.) and the surface of the concrete of not less than:
- (i) 40 mm to unprotected ground.
 - (ii) 30 mm to a membrane in contact with the ground.
 - (iii) 20 mm to an internal surface.

FOOTINGS AND SLABS

- (iv) 40 mm to external exposure.
- (e) Reinforcement must be cleaned of loose rust, mud, paints and oils immediately prior to the concrete pour.

Explanatory information:

In order to obtain a good bond between concrete and reinforcement, the reinforcement should be free of contamination by mud, paint, oils, etc. It is not necessary for the reinforcement to be completely free of rust. Some rusting is beneficial in promoting a good bond as it roughens the surface of the steel. Loose rust, however, must be removed from the reinforcement.

- (f) Reinforcement must be placed as follows:
 - (i) All reinforcement must be firmly fixed in place to prevent it moving during concreting operations.
 - (ii) Reinforcement must be supported off the ground or the forms by bar chairs made from wire, concrete or plastic.
 - (iii) When using wire chairs the minimum concrete cover (see [3.2.3.2\(d\)](#)) to the uncoated portion of the chair must be obtained.
 - (iv) Wire chairs on soft ground or plastic membrane must be placed on flat bases.
 - (v) Bar chairs must be spaced at not more than 800 mm centres for steel fabric.

Explanatory information:

Reinforcement is designed to be in a particular place so as to add strength or to control cracking of the concrete. A displacement from its intended location could make a significant difference to the life or serviceability of the structure.

Supports for fabric reinforcement are provided to prevent the fabric distorting when workers walk on top of it to place the concrete and maintain the correct concrete cover to the fabric.

PART 3.2.4 SITE CLASSIFICATION

3.2.4.1 Site classification

The *foundation* where the footing is to be located must be classified in accordance with AS 2870.

Explanatory information:

Table 3.2.4.1 provides a general description of *foundation* soil types that will assist in the classification of the *site*. More detailed information, including differentiation between classifications, can be found in AS 2870 or alternatively contact the *appropriate authority*.

Due to the limitations of this Part, if a *site* is classified as E or P then reference must be made to AS 2870 for design and construction information.

Table 3.2.4.1 GENERAL DEFINITION OF SITE CLASSES

Class	Foundation
A	Most sand and rock <i>sites</i> with little or no ground movement from moisture changes
S	Slightly reactive clay <i>sites</i> with only slight ground movement from moisture changes
M	Moderately reactive clay or silt <i>sites</i> which can experience moderate ground movement from moisture changes
H	Highly reactive clay <i>sites</i> which can experience high ground movement from moisture changes
E	Extremely reactive clay <i>sites</i> which can experience extreme ground movement from moisture changes
A to P	Filled <i>sites</i> — see AS 2870
P	<i>Sites</i> which include soft soils, such as soft clay or silt or loose sands; landslip; mine subsidence; collapsing soils; soils subject to erosion; reactive <i>sites</i> subject to abnormal moisture conditions or <i>sites</i> which cannot be classified otherwise

Note: For classes M, H and E further division based on the depth of the expected movement is *required*. For deep-seated movements, characteristic of dry climates and corresponding to a design depth of suction change H_s , equal to or greater than 3 m, the classification shall be M-D, H-D or E-D as appropriate. For example, H-D represents a highly reactive *site* with deep moisture changes, and H represents a highly reactive site with shallow moisture changes.

PART 3.2.5 FOOTING AND SLAB CONSTRUCTION

Explanatory information:

The footings included in this Part reflect the requirements of AS 2870 and apply to the most common types of soil conditions. If the soil conditions on *site* are not covered by this Part then additional guidance can be obtained from AS 2870 or the *appropriate authority*.

These provisions are not meant to prohibit the use of alternative traditional footing methods found through experience to be suitable for local soil conditions (especially those used in stable soils). Such footings may be appropriate, provided they meet the relevant *Performance Requirements* listed in **Section 2**.

The diagrams in this Part reflect acceptable footing designs only. They do not provide details for termite management systems such as the correct placement of ant capping and slab edge exposure.

For details on termite management systems, see **Part 3.1.3**.

3.2.5.1 Footing and slab construction

- (a) Footing and slab construction, including size and placement of reinforcement, must comply with the relevant provisions of this Part and the following details:
 - (i) Footings for stumps — the appropriate details in **3.2.5.6** and **Table 3.2.5.2**.
 - (ii) Stiffened raft Class A, S, M, M-D, H and H-D *sites* — the appropriate details in **Figure 3.2.5.3(a)** and **Figure 3.2.5.3(b)**.
 - (iii) Strip footing systems in Class A, S, M, M-D and H *sites* — the appropriate details in **Figure 3.2.5.4(a)** and **Figure 3.2.5.4(b)**.
 - (iv) Footing slabs for Class A *sites* — the appropriate details in **Figure 3.2.5.5**.
- (b) Footings for *single leaf masonry*, *mixed construction* and earth wall masonry must comply with the equivalent footing construction set out in **Table 3.2.5.1**.

3.2.5.2 Footings and slabs to extensions to existing buildings

- (a) Footings to extensions to Class 1 or 10 buildings may be of similar proportions and details to those used with an existing same Class of building on the same allotment provided—
 - (i) masonry and masonry veneer walls are articulated at the junction with the existing building; and
 - (ii) the performance of the existing building has been satisfactory, i.e. there has been no significant cracking or movement (see Section 2 of AS 2870 for acceptable footing performance); and
 - (iii) there are no unusual moisture conditions on the *site*.
- (b) Class 10 buildings of *clad framed* construction may use footing systems appropriate for one class of reactivity less severe than for a house (e.g. site classification M can be reduced to S).

FOOTINGS AND SLABS

Table 3.2.5.1 EQUIVALENT FOOTING CONSTRUCTION

Actual construction		Equivalent footing construction (see Figure 3.2.5.2 to 5)
External walls	Internal walls	
Single leaf masonry		
Reinforced <i>single leaf masonry</i>	<i>Articulated masonry</i> on Class A and S <i>sites</i> ; or framed	<i>Articulated masonry</i> veneer
Reinforced <i>single leaf masonry</i>	<i>Articulated masonry</i> or reinforced <i>single leaf masonry</i>	Masonry veneer
Articulated <i>single leaf masonry</i>	<i>Articulated masonry</i>	Articulated full masonry
Mixed construction		
Full masonry	Framed	Articulated full masonry
Articulated full masonry	Framed	Masonry veneer
Earth wall masonry		
Infill panels of earth masonry	Framed earth masonry	<i>Articulated masonry</i> veneer
<i>Loadbearing</i> earth masonry	<i>Loadbearing</i> earth masonry	Articulated full masonry

3.2.5.3 Shrinkage control

- (a) Where brittle floor coverings, such as ceramic tiles, are to be used over an area greater than 16 m², one of the following additional measures must be taken to control the effect of shrinkage cracking—
- (i) the amount of shrinkage reinforcement (steel reinforcement mesh in the slab panel) must be—
 - (A) increased to SL92 or equivalent throughout the affected slab area; or
 - (B) doubled with an additional sheet of slab mesh throughout the affected slab area; or
 - (ii) the bedding system for brittle coverings must be selected on the basis of the expected slab movement and the characteristics of the floor covering (including the use of expansion joints etc.); or
 - (iii) the placement of floor covering must be delayed for not less than 3 months after the concrete has been poured.
- (b) At re-entrant or internal corners, two strips, minimum 2 m in length, of 3–L8TM or one strip of 3–L11TM (or 3–N12 bars) must be placed diagonally across the corner in accordance with [Figure 3.2.5.1](#).

FOOTINGS AND SLABS

Figure 3.2.5.1

REINFORCING AT RE-ENTRANT CORNERS

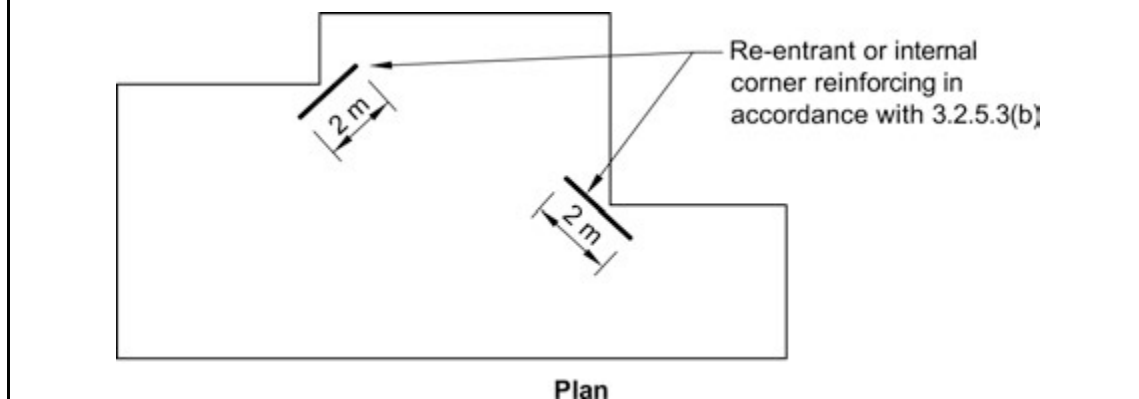

3.2.5.4 Minimum edge beam dimensions

Except for *waffle raft* slabs, where the edge rebate is more than 150 mm in depth, the width of the edge beam at the base of the rebate must not be less than 200 mm, except that if R10 or N10 ties at 900 mm spacing (or equivalent) are provided to resist vertical forces, the width of the edge beam at the base of the rebate can be reduced to 150 mm.

3.2.5.5 Footings for fireplaces on Class A and S sites

- (a) Fireplaces must be supported on a pad footing—
- (i) 150 mm thick for single storey (one trafficable floor and a wall height not more than 4.2 m) construction; and
 - (ii) 200 mm thick for 2 storey (two trafficable floors and a wall height not more than 8 m) construction; and
 - (iii) reinforced top and bottom with SL72 mesh; and
 - (iv) extending 300 mm past the edges of the masonry except for any edge flush with the outer wall.
- (b) The pad footing may form an integral part of the slab.

3.2.5.6 Stump footing details

- (a) Footings for stumps must comply with—
- (i) the provisions of [Table 3.2.5.2](#) for Class A and Class S *sites*; or
 - (ii) the appropriate acceptable construction manual listed in—
 - (A) [Part 3.4.3](#); or
 - (B) [3.2.0](#).
- (b) Concrete stumps must—
- (i) be designed in accordance with—
 - (A) AS 3600; or
 - (B) [Table 3.2.5.2](#); and

FOOTINGS AND SLABS

- (ii) use a minimum 20 MPa concrete as defined in AS 3600.
- (c) Steel stumps must be—
 - (i) designed in accordance with—
 - (A) AS 4100; or
 - (B) **Table 3.2.5.2**; and
 - (ii) fully enclosed and sealed with a welded top plate; and
 - (iii) encased in concrete sloping away from the stump and finishing not less than 100 mm above *finished ground level*; and
 - (iv) corrosion protected in accordance with **Part 3.4.4**.
- (d) Timber stumps must be designed in accordance with—
 - (i) AS 1684 Parts 2, 3 or 4; or
 - (ii) **Table 3.2.5.2**.
- (e) Stumps must be braced—
 - (i) by a full perimeter masonry base; or
 - (ii) for concrete stumps — in accordance with AS 3600; or
 - (iii) for steel stumps — in accordance with AS 4100; or
 - (iv) for timber stumps — in accordance with AS 1684 Parts 2, 3 or 4.
- (f) Stumps must be embedded into the foundation material not less than 30% of their height above ground level or 450 mm, whichever is the greater.

Table 3.2.5.2 STUMP FOOTING — IN AREAS WITH A DESIGN WIND SPEED OF NOT MORE THAN N2

LENGTH OF STUMP (mm) (including embedded length)	CONCRETE		STEEL	TIMBER
	Minimum size (mm)	REINFORCEMENT Number of 5 mm (min.) hard drawn wires	Minimum size (mm) (SHS = square hollow section)	Minimum size (mm)
Less than 1400	100 × 100 or 110 diameter	1	75 × 75 × 2.0 SHS	100 × 100 or 110 diameter
1401–1800	100 × 100 or 110 diameter	2	75 × 75 × 2.0 SHS	100 × 100 or 110 diameter
1801–3000	125 × 125 or 140 diameter	2	75 × 75 × 2.0 SHS	100 × 100 or 110 diameter

FOOTINGS AND SLABS

Figure 3.2.5.3(a)

FOOTING SLAB AND STIFFENED RAFT SLAB DETAILS FOR CLASS A AND S SITES

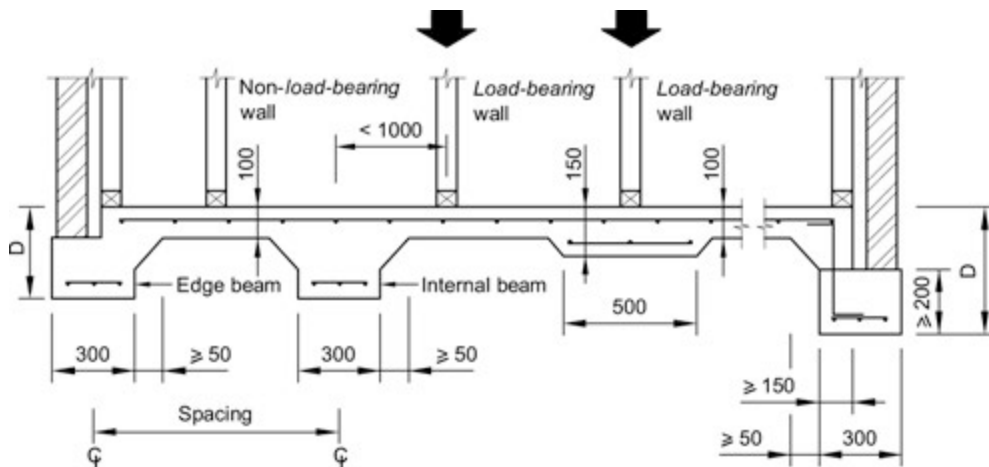

REINFORCEMENT FOR STIFFENED RAFT FOOTINGS					Slab Fabric		
Site Class	Type of Construction	Depth (D) mm	Bottom reinf.	Max. spacing c/l to c/l (m)	Slab length <18 m	Slab length <25 m	Slab length <30 m
Class A	<i>Clad Frame</i>	300	3–L8TM	–	SL72	SL82	SL92
	<i>Articulated masonry veneer</i>	300	3–L8TM	–	SL72	SL82	SL92
	Masonry veneer	300	3–L8TM	–	SL72	SL82	SL92
	Articulated full masonry	400	3–L8TM	–	SL72	SL82	SL92
	Full masonry	400	3–L8TM	–	SL72	SL82	SL92
Class S	<i>Clad Frame</i>	300	3–L8TM	–	SL72	SL82	SL92
	<i>Articulated masonry veneer</i>	300	3–L8TM	–	SL72	SL82	SL92
	Masonry veneer	300	3–L11TM	–	SL72	SL82	SL92
	Articulated full masonry	400	3–L11TM	–	SL72	SL82	SL92
	Full masonry	450	3–L11TM	5.0 ^{Note 2}	SL82	SL82	SL92

Notes:

- Internal and external edge beams must be arranged to form an integral structural grid (see clauses 5.3.8 and 5.3.9 of AS 2870).
- A 10% increase in spacings is permitted where the spacing in the other direction is 20% less than that specified.
- Where external beams are wider than 300 mm, an extra bottom bar or equivalent of the same bar size is required for each 100 mm additional width.

FOOTINGS AND SLABS

Figure 3.2.5.3(a)

FOOTING SLAB AND STIFFENED RAFT SLAB DETAILS FOR CLASS A AND S SITES

- Where a reinforced *single leaf masonry* wall is constructed directly above and structurally connected to a concrete edge beam, the beam may be reduced to 300 mm wide by 300 mm deep and reinforced with 3–L8TM reinforcement.
- Alternative reinforcement sizes must comply with AS 2870.
- Internal beam details and spacings shall comply with [Figure 3.2.5.3\(a\)](#) or [\(b\)](#). At a re-entrant corner where an external beam continues as an internal beam, the internal beam details shall be continued for a length of 1 m into the external beam.

Figure 3.2.5.3(b)

FOOTING SLAB AND STIFFENED RAFT SLAB DETAILS FOR CLASS M, M-D, H AND H-D SITES

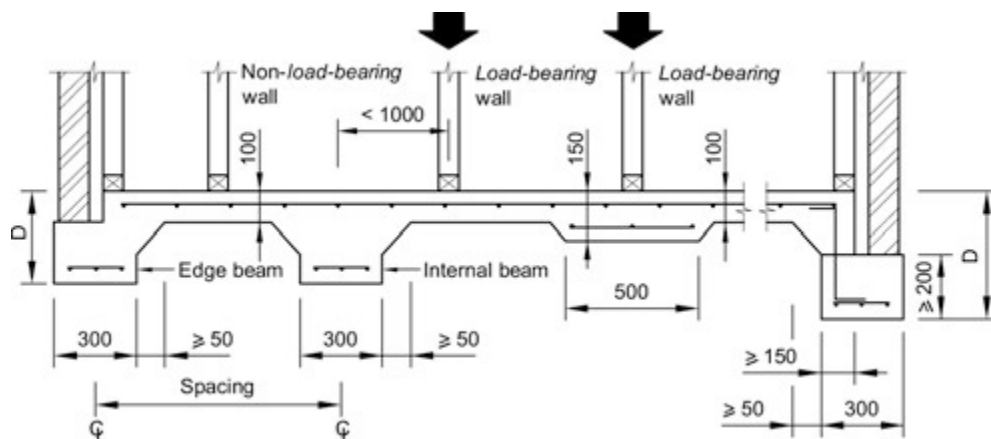

REINFORCEMENT FOR STIFFENED RAFT FOOTINGS					Slab Mesh		
Site Class	Type of Construction	Depth (D) mm	Bottom reinf.	Max. spacing c/l to c/l (m)	Slab length <18 m	Slab length <25 m	Slab length <30 m
Class M	<i>Clad Frame</i>	300	3–L11TM	6.0 ^{Note 2}	SL72	SL82	SL92
	<i>Articulated masonry veneer</i>	400	3–L11TM	6.0 ^{Note 2}	SL72	SL82	SL92
	Masonry veneer	400	3–L11TM	5.0 ^{Note 2}	SL72	SL82	SL92
	Articulated full masonry	500	3–L12TM	4.0	SL82	SL82	SL92
	Full masonry	800	3–N16	4.0	SL92	SL92	SL92

FOOTINGS AND SLABS

Figure 3.2.5.3(b)

FOOTING SLAB AND STIFFENED RAFT SLAB DETAILS FOR CLASS M, M-D, H AND H-D SITES

Class M-D	<i>Clad Frame</i>	400	3-L11TM	5.0 ^{Note 2}	SL72	SL82	SL92
	<i>Articulated masonry veneer</i>	400	3-L11TM	4.0	SL72	SL82	SL92
	Masonry veneer	500	3-L12TM	4.0	SL82	SL82	SL92
	Articulated full masonry	625	3-L12TM	4.0	SL92	SL92	SL92
	Full masonry	–	–	–	–	–	–
Class H	<i>Clad Frame</i>	400	3-L11TM	5.0 ^{Note 2}	SL72	SL82	SL92
	<i>Articulated masonry veneer</i>	500	3-L12TM	4.0	SL82	SL82	SL92
	Masonry veneer	700	3-N16	4.0	SL92	SL92	SL92
	Articulated full masonry	1000	4-N16	4.0	SL102	SL102	SL102
	Full masonry	–	–	–	–	–	–
Class H-D	<i>Clad Frame</i>	500	3-L11TM	4.0	SL82	SL82	SL92
	<i>Articulated masonry veneer</i>	600	3-L12TM	4.0	SL92	SL92	SL92
	Masonry veneer	–	–	–	–	–	–
	Articulated full masonry	1200	4-N16	4.0	SL102	SL102	SL102
	Full masonry	–	–	–	–	–	–

Notes:

1. Internal and external edge beams must be arranged to form an integral structural grid (see clauses 5.3.8 and 5.3.9 of AS 2870).
2. A 10% increase in spacings is permitted where the spacing in the other direction is 20% less than that specified.
3. Where external beams are wider than 300 mm, an extra bottom bar or equivalent of the same bar size is required for each 100 mm additional width.
4. Where a reinforced *single leaf masonry* wall is constructed directly above and structurally connected to a concrete edge beam, the beam may be reduced to 300 mm wide by 300 mm deep and reinforced with 3-L8TM reinforcement.
5. Alternative reinforcement sizes must comply with AS 2870.

FOOTINGS AND SLABS

Figure 3.2.5.3(b)

FOOTING SLAB AND STIFFENED RAFT SLAB DETAILS FOR CLASS M, M-D, H AND H-D SITES

6. Internal beam details and spacings shall comply with [Figure 3.2.5.3\(b\)](#). At a re-entrant corner where an external beam continues as an internal beam, the internal beam details shall be continued for a length of 1 m into the external beam.

Figure 3.2.5.4(a)

STRIP FOOTING SYSTEMS IN CLASS A AND S SITES

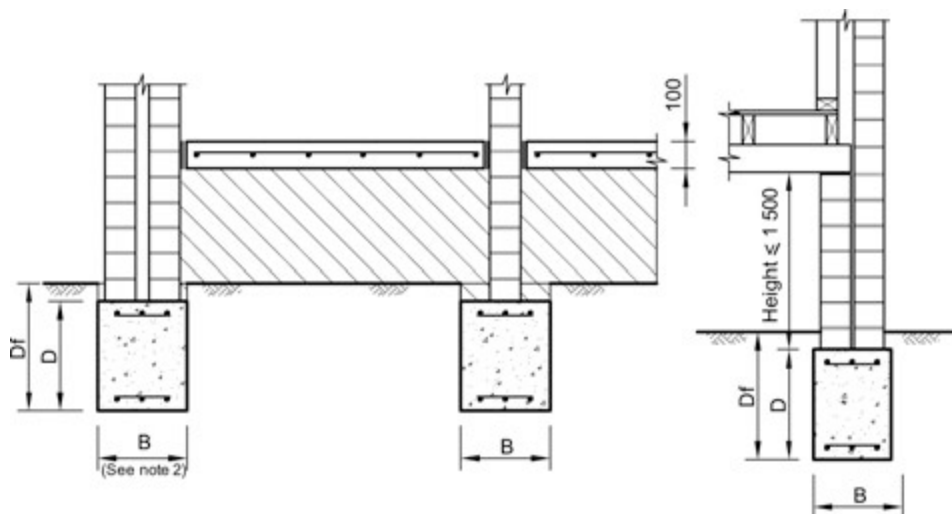

DIMENSIONS AND REINFORCEMENT FOR STRIP FOOTING SYSTEMS

Site Class	Type of construction	D	B	Reinforcement (top and bottom)
Class A	<i>Clad frame</i>	300	300	3-L8TM
	<i>Articulated masonry veneer</i>	300	300	3-L8TM
	Masonry veneer	300	300	3-L8TM
	Articulated full masonry	300	400	4-L8TM
	Full masonry	300	400	4-L8TM
Class S	<i>Clad frame</i>	400	300	3-L8TM
	<i>Articulated masonry veneer</i>	400	300	3-L8TM
	Masonry veneer	400	300	3-L8TM
	Articulated full masonry	400	400	4-L11TM
	Full masonry	500	400	4-L11TM

Notes:

1. All masonry walls must be supported on strip footings.

FOOTINGS AND SLABS

Figure 3.2.5.4(a)
STRIP FOOTING SYSTEMS IN CLASS A AND S SITES

2. Internal strip footings shall be of the same proportions as the external footings and run from external footing to external footing. "Side slip joints" consisting of a double layer of polyethylene shall be provided at the sides of the footing only.
3. Infill floors may be concrete slabs, brick paving, stone flags or compacted and stabilised earth. For concrete slab infill panels, mesh may be required to control shrinkage in slab panels and around openings or restrained regions. Concrete infill slabs must use a minimum of SL62 mesh to control shrinkage (see also 3.2.5.3).
4. Where footings are wider than the specified width, an extra bottom bar or equivalent of the same bar size is required for each 100 mm additional width. If strip footings deeper than those required are used, the reinforcement shall be increased to match that specified for the deepened proportions.
5. The measurement of D_f is greater or equal to D plus 75 mm.
6. Alternative reinforcing sizes must comply with AS 2870.

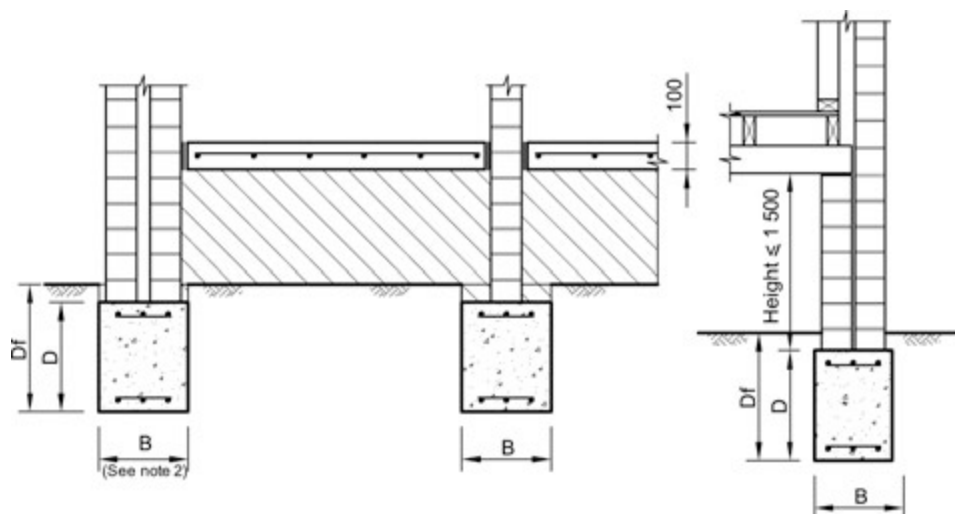
Figure 3.2.5.4(b)
STRIP FOOTING SYSTEMS IN CLASS M, M-D AND H SITES

DIMENSIONS AND REINFORCEMENT FOR STRIP FOOTING SYSTEMS

Site Class	Type of construction	D	B	Reinforcement (top and bottom)
Class M	<i>Clad frame</i>	400	300	3-L11TM
	<i>Articulated masonry</i> veneer	450	300	3-L11TM
	Masonry veneer	500	300	3-L12TM
	Articulated full masonry	600	400	4-L12TM
	Full masonry	900 ^{Note 2}	400	4-L12TM

FOOTINGS AND SLABS

Figure 3.2.5.4(b)

STRIP FOOTING SYSTEMS IN CLASS M, M-D AND H SITES

Class M-D	<i>Clad frame</i>	500	300	3-L11TM
	<i>Articulated masonry</i> veneer	550	300	3-L12TM
	Masonry veneer	700 ^{Note 2}	300	3-N16
	Articulated full masonry	1100 ^{Note 2}	400	4-N16
Class H	<i>Clad frame</i>	500	300	3-L11TM
	<i>Articulated masonry</i> veneer	600	300	3-L12TM
	Masonry veneer	850 ^{Note 2}	300	3-N16
	Articulated full masonry	1100 ^{Note 2}	400	4-N16

Notes:

- All masonry walls must be supported on strip footings.
- For beams 700 mm or deeper, as specified in the table above, internal footings shall be provided at no more than 6 m centres and at re-entrant corners to continue footings to the opposite external footing. Internal strip footings shall be of the same proportions as the external footings and run from external footing to external footing. "Side slip joints" consisting of a double layer of polyethylene shall be provided at the sides of the footing only.
- Infill floors shall only be used for Class A and S sites.
- Where footings are wider than the specified width, an extra bottom bar or equivalent of the same bar size is required for each 100 mm additional width. If strip footings deeper than those required are used, the reinforcement shall be increased to match that specified for the deepened proportions.
- The measurement of D_f is greater or equal to D plus 75 mm.
- Alternative reinforcing sizes must comply with AS 2870.
- For Class M articulated full masonry and full masonry, internal strip footings must be of the same proportions as the external footing and run from external footing to external footing.
- For site Classes M-D and H, a provision shall be made by methods such as an adequate crawl space to allow for future re-levelling due to drying effects.

FOOTINGS AND SLABS

Figure 3.2.5.5

FOOTING SLABS FOR CLASS A SITES SUITABLE FOR:

- (a) **CLAD FRAME.**
- (b) **ARTICULATED MASONRY VENEER.**
- (c) **MASONRY VENEER.**
- (d) **ARTICULATED FULL MASONRY.**
- (e) **FULL MASONRY.**

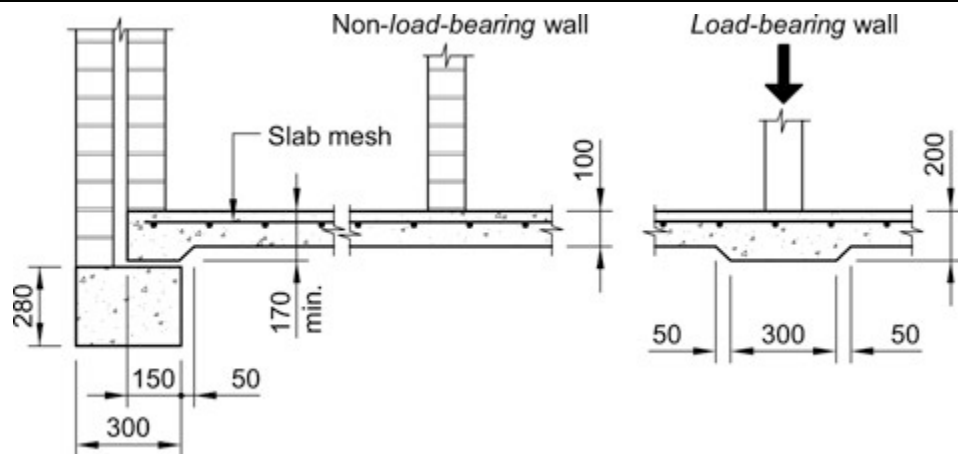
**Notes:**

1. Use SL63 when slab length is less than 12 m.
2. Use SL62 when slab length is less than 18 m.
3. Use SL72 when slab length is less than 25 m.
4. Use SL82 when slab length is less than 30 m
5. In parts of Western Australia (around Perth) and other locations where the *site* consists of extremely stable sands, and where specified by a *professional engineer*, the slab thickness may be reduced to 85 mm and reinforced as follows:
 - (a) Use SL53 when slab length is less than or equal to 12 m.
 - (b) Use SL63 when slab length is less than or equal to 18 m.
 - (c) Use SL62 when slab length is less than or equal to 25 m.
6. Dune sands may require compaction.

MASONRY

3.3 Definitions

3.3.1 Unreinforced Masonry

3.3.2 Reinforced Masonry

3.3.3 Masonry Accessories

3.3.4 Weatherproofing of Masonry

3.3.5 Earthwall Construction

PART 3.3 CONTENTS

PART 3.3 MASONRY

3.3 Definitions

3.3.1 Unreinforced Masonry

3.3.1.0 Acceptable construction manual

3.3.2 Reinforced Masonry

3.3.2.0 Acceptable construction manual

3.3.3 Masonry Accessories

3.3.3.0 Acceptable construction manual

3.3.4 Weatherproofing of Masonry

3.3.4 Application of this Part

3.3.4.0 Acceptable construction manual

3.3.5 Earthwall Construction

Definitions

3.3

The following definitions are used in this Part:

Reinforced masonry means masonry reinforced with steel reinforcement that is placed in a bed joint or grouted into a core to strengthen the masonry.

Unreinforced masonry means masonry that is not reinforced.

PART 3.3.1 UNREINFORCED MASONRY

Appropriate *Performance Requirements*

Where an alternative masonry walling system is proposed as an *Alternative Solution* to that described in **Part 3.3.1**, that proposal must comply with—

- (a) *Performance Requirement P2.1.1*; and
- (b) the relevant *Performance Requirements* determined in accordance with **1.0.10**.

A. Acceptable construction manual

3.3.1.0

Performance Requirement P2.1.1 is satisfied for *unreinforced masonry* (including masonry-veneer) if it is designed and constructed in accordance with one of the following:

- (a) AS 3700.
- (b) AS 4773 Parts 1 and 2.

Explanatory information:

Composite construction: Design requirements for other materials that may be used in combination with masonry i.e. heavy steel support beams etc. are described in **Part 3.11** — Structural design.

PART 3.3.2 REINFORCED MASONRY

Appropriate *Performance Requirements*

Where an alternative *reinforced masonry* system is proposed as an *Alternative Solution* to that described in **Part 3.3.2**, that proposal must comply with—

- (a) *Performance Requirement P2.1.1*; and
- (b) the relevant *Performance Requirements* determined in accordance with **1.0.10**.

A. Acceptable construction manual
--

3.3.2.0

Performance Requirement P2.1.1 is satisfied for *reinforced masonry* if it is designed and constructed in accordance with one of the following:

- (a) AS 3700.
- (b) AS 4773 Parts 1 and 2.

Explanatory information:

Design requirements for other materials that may be used in combination with masonry (heavy steel support beams etc.) are described in **Part 3.11** — Structural design.

PART 3.3.3 MASONRY ACCESSORIES

Appropriate *Performance Requirements*

Where an alternative masonry accessory is proposed as an *Alternative Solution* to that described in **Part 3.3.3**, that proposal must comply with—

- (a) *Performance Requirement P2.1.1*; and
- (b) the relevant *Performance Requirements* determined in accordance with **1.0.10**.

A. Acceptable construction manual
--

3.3.3.0

Performance Requirement P2.1.1 is satisfied for masonry accessories if they are constructed and installed in accordance with one of the following:

- (a) AS 3700.
- (b) AS 4773 Parts 1 and 2.

PART 3.3.4 WEATHERPROOFING OF MASONRY

Appropriate *Performance Requirements*

Where an alternative waterproofing system is proposed as an *Alternative Solution* to that described in **Part 3.3.4**, that proposal must comply with—

- (a) *Performance Requirement P2.2.2*; and
- (b) *Performance Requirement P2.2.3*; and
- (c) the relevant *Performance Requirements* determined in accordance with **1.0.10**.

3.3.4 Application of this Part

- (a) This Part applies to every *external wall* (including the junction between the wall and any *window* or door) of a Class 1 building.
- (b) This Part does not apply to any Class 10 building except where its construction contributes to the weatherproofing of the Class 1 building.

A. Acceptable construction manual

3.3.4.0

Performance Requirement P2.2.2 is satisfied for weatherproofing of masonry if it is carried out in accordance with the appropriate provisions of one of the following:

- (a) AS 3700.
- (b) AS 4773 Parts 1 and 2.

STATE AND TERRITORY VARIATIONS

In South Australia, delete 3.3.4.0 and insert SA 3.3.4.0 as follows:

Performance Requirement P2.2.2 is satisfied for weatherproofing of masonry if it is carried out in accordance with the appropriate provisions of—

- (a) AS 3700 — Masonry structures; or
- (b) AS 4773 — Masonry for small buildings, Parts 1 and 2,

except that metals and bitumen-coated metals referred to in clauses 7.2 and 7.3 of AS/NZS 2904 are not acceptable materials for use as *damp-proof courses* in South Australia; and

- (c) in *low rainfall intensity areas* where the site classification is A, S, M, M-D, H, H1, H2, H-D, H1-D or H2-D in accordance with AS 2870, the height of the *damp-proof course* may be —
 - (i) 15 mm above finished paved, concreted or landscaped areas; or

MASONRY

- (ii) 0 mm if the *damp-proof course* is protected from the direct effects of the weather by a carport, verandah or the like.

PART 3.3.5 EARTH WALL CONSTRUCTION

This Part has deliberately been left blank.

PART **3.4**

FRAMING

- 3.4.0 Framing**
- 3.4.1 Sub-floor ventilation**
- 3.4.2 Steel framing**
- 3.4.3 Timber framing**
- 3.4.4 Structural steel members**

PART 3.4 CONTENTS

PART 3.4 FRAMING

3.4.0 Framing

- 3.4.0.1 Explanation of terms
- 3.4.0.2 Structural software

3.4.1 Sub-Floor Ventilation

- 3.4.1.1 Application
- 3.4.1.2 Sub-floor ventilation

3.4.2 Steel Framing

- 3.4.2.0 Acceptable construction manuals
- 3.4.2.1 Application
- 3.4.2.2 General
- 3.4.2.3 Steel floor framing
- 3.4.2.4 * * * * *
- 3.4.2.5 * * * * *
- 3.4.2.6 Installation of services

3.4.3 Timber Framing

- 3.4.3.0 Acceptable construction manuals

3.4.4 Structural Steel Members

- 3.4.4 Explanation of terms
- 3.4.4.0 Acceptable construction manuals
- 3.4.4.1 Application
- 3.4.4.2 Structural steel members
- 3.4.4.3 Columns
- 3.4.4.4 Corrosion protection

PART 3.4.0 FRAMING

3.4.0.1 Explanation of terms

The following diagrams depict framing members and associated terminology used to describe them in the *Housing Provisions*.

In most cases the terminology is applicable for both steel and timber frame members.

Figure 3.4.0.1

SPAN AND SPACING TERMS

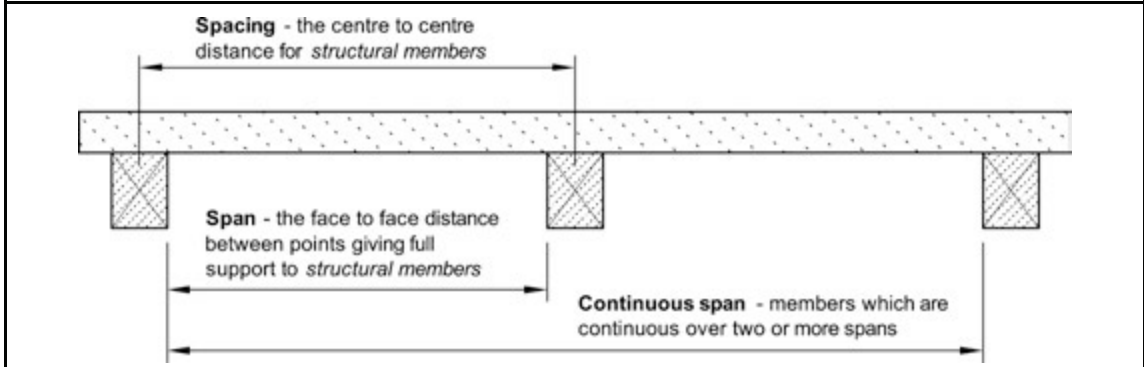
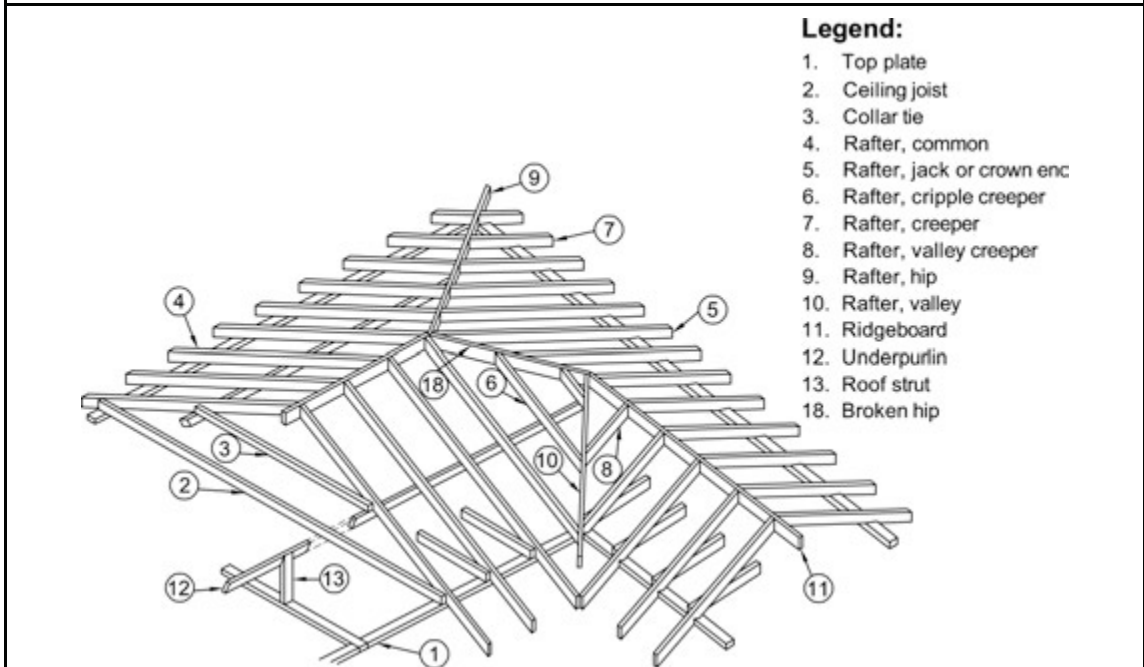

Figure 3.4.0.2

TYPICAL ROOF FRAMING MEMBERS



FRAMING

Figure 3.4.0.3

TYPICAL WALL, FLOOR AND CEILING FRAMING MEMBERS

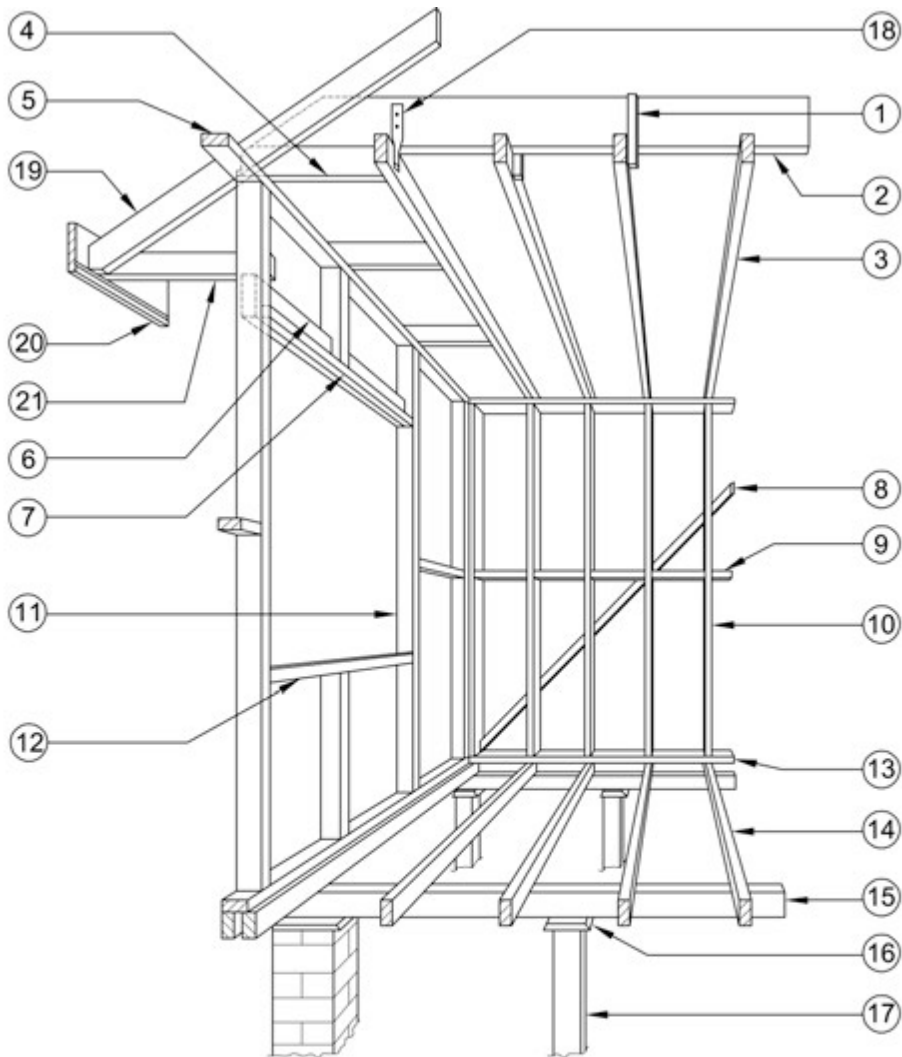

Legend:	1. Cleat	8. Brace	15. Bearer
	2. Hanging beam	9. Nogging	16. Termite shield
	3. Ceiling joist	10. Stud	17. Stump
	4. Jack joist	11. Jamb stud	18. Hoop iron strap
	5. Top wall plate	12. Sill trimmer	19. Rafter
	6. Lintel	13. Bottom wall plate	20. Fascia
7. Ledger	14. Floor joist	21. Soffit bearer	

3.4.0.2 Structural software

- (a) Structural software used in computer aided design of a building or structure, that uses design criteria based on the *Deemed-to-Satisfy Provisions* of the *Housing Provisions*,

FRAMING

including its referenced documents, must comply with the ABCB Protocol for Structural Software.

- (b) The requirements of (a) only apply to structural software used to design steel or timber trussed roof and floor systems and framed building systems for buildings within the following geometrical limits:
- (i) The distance from ground level to the underside of eaves must not exceed 6 m.
 - (ii) The distance from ground level to the highest point of the roof, neglecting chimneys, must not exceed 8.5 m.
 - (iii) The building width including roofed verandahs, excluding eaves, must not exceed 16 m.
 - (iv) The building length must not exceed five times the building width.
 - (v) The roof pitch must not exceed 35 degrees.
- (c) The requirements of (a) do not apply to design software for individual frame members such as electronic tables similar to those provided in AS 1684.

Explanatory information:

3.4.0.2 does not apply where a software package simply eliminates manual calculations and the process of the package requires identical methodology as that undertaken manually, (eg AS 1684 span tables and bracing calculations).

PART 3.4.1 SUB-FLOOR VENTILATION

Appropriate *Performance Requirements*

Where an alternative sub-floor ventilation system is proposed as an *Alternative Solution* to that described in **Part 3.4.1**, that proposal must comply with—

- (a) *Performance Requirement P2.2.3*; and
- (b) the relevant *Performance Requirements* determined in accordance with **1.0.10**.

Acceptable construction practice

3.4.1.1 Application

Compliance with this acceptable construction practice satisfies *Performance Requirement P2.2.3* for sub-floor ventilation.

3.4.1.2 Sub-floor ventilation

The sub-floor space between a suspended floor of a building and the ground must be in accordance with the following:

- (a) The sub-floor space must—
 - (i) be cleared of all building debris and vegetation; and
 - (ii) be cross-ventilated by means of openings; and
 - (iii) contain no dead air spaces; and
 - (iv) be graded in accordance with **3.1.2.3**; and
 - (v) have evenly spaced ventilation openings in accordance with **Figure 3.4.1, Diagram a**.
- (b) In double leaf masonry walls, the cross ventilation openings specified in (a) must be provided in both leaves of the masonry, with inner-leaf openings being aligned with outer leaf openings to allow an unobstructed flow of air.
- (c) *Internal walls* constructed in sub-floor spaces must be provided with openings—
 - (i) having an unobstructed area equivalent to that *required* for the adjacent external openings; and
 - (ii) which are evenly distributed throughout such *internal walls*.
- (d) The clearance between the ground surface and the underside of the floor, must be in accordance with **Table 3.4.1.2**.
- (e) The sub-floor ventilation openings in *internal* and *external walls* must be in accordance with **Table 3.4.1.2** for the climatic zones given in **Figure 3.4.1.2**.

FRAMING

- (f) Where ventilation is obstructed by patios, paving or the like, additional ventilation must be provided to ensure that the overall level of ventilation is maintained.
- (g) Where the ground or sub-floor space is excessively damp or subject to frequent flooding, in addition to the requirements of (a) to (f)—
- (i) the area of sub-floor ventilation *required* in (e) must be increased by 50%; or
 - (ii) a sealed impervious membrane must be provided over the ground; or
 - (iii) durability Class 1 or 2 timbers or H3 preservative treated timbers in accordance with AS 1684 Parts 2, 3 or 4.

Figure 3.4.1

TYPICAL SUB-FLOOR VENTILATION DETAILS

Diagram a.

Typical Cross Ventilation of Sub-Floor Area

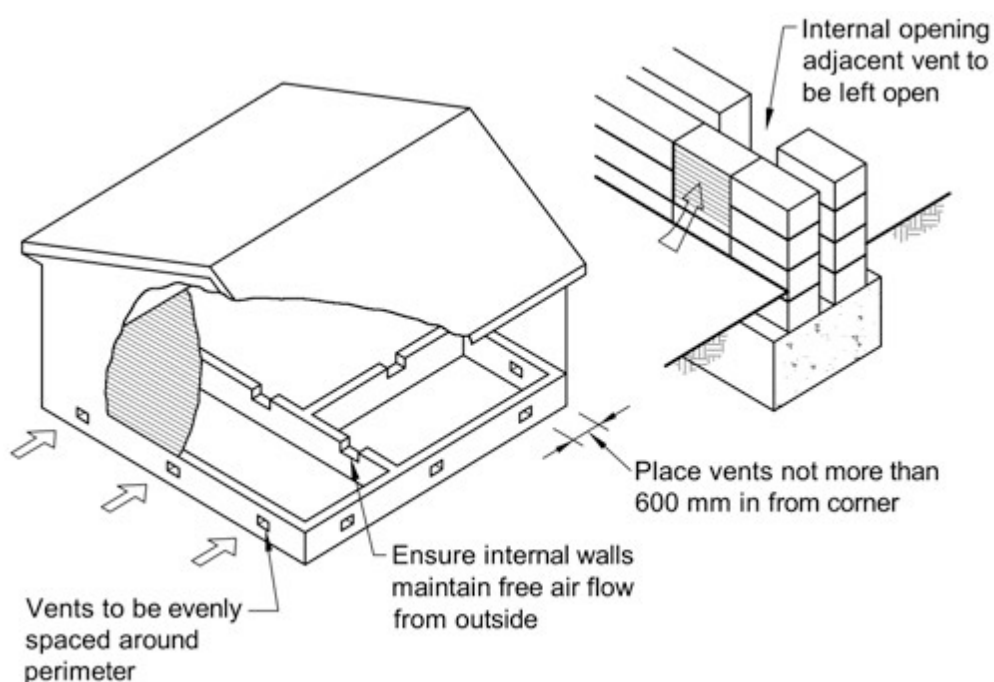

FRAMING

Figure 3.4.1

TYPICAL SUB-FLOOR VENTILATION DETAILS

Diagram b.

Sub-Floor Clearance Requirements on a Sloping Site

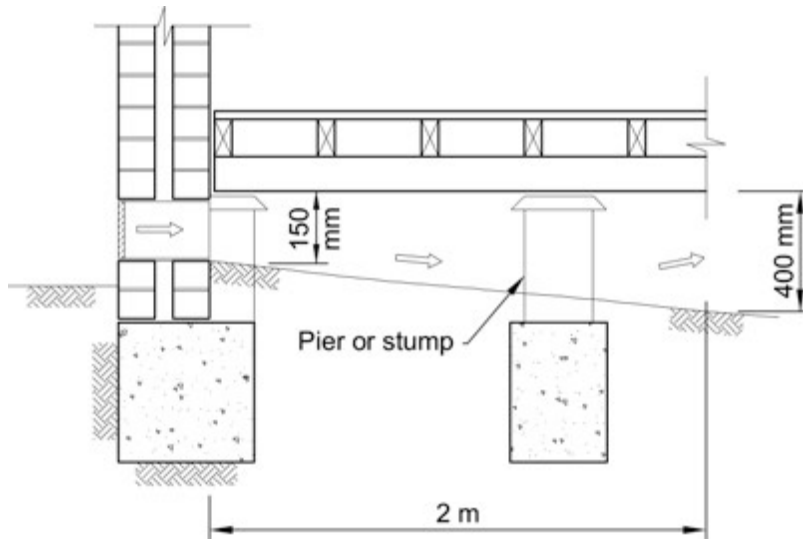

Notes:

1. 400 mm clearance *required* only where termite management systems are installed that need to be inspected (see Part 3.1.3); and
2. On sloping *sites* the 400 mm clearance *required* by (1) may be reduced to 150 mm within 2 m of *external walls* in accordance with Diagram b.

FRAMING

Figure 3.4.1.2

CLIMATIC ZONES BASED ON RELATIVE HUMIDITY

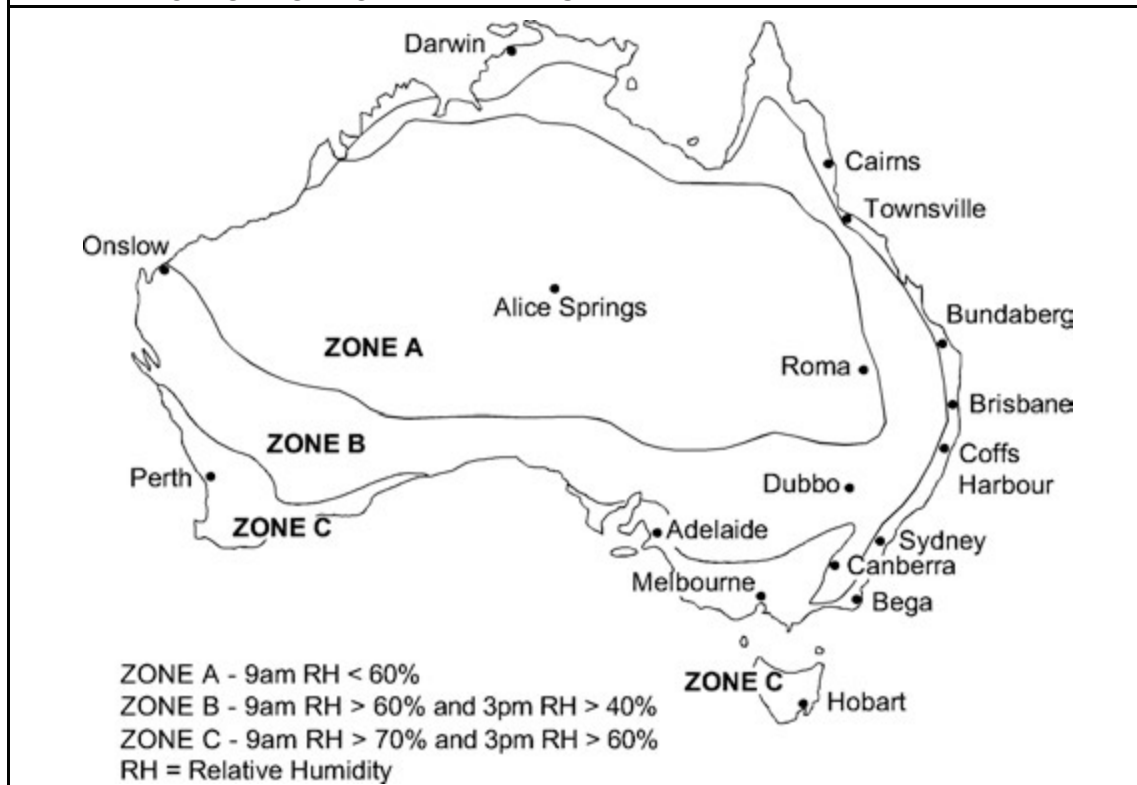

Table 3.4.1.2 SUB-FLOOR VENTILATION AND CLEARANCE

CLIMATIC ZONE (see Figure 3.4.1.2)	Minimum sub-floor ventilation (mm ² /m of wall)		Minimum height from ground surface (mm)	
	No membrane	Ground sealed with impervious membrane	Termite inspection not required	Termite inspection required (see Note)
A	2000	1000	150	400
B	4000	2000	150	400
C	6000	3000	150	400

Note: On sloping *sites*, 400 mm clearance may be reduced to 150 mm within 2 m of *external walls* in accordance with [Figure 3.4.1 Diagram b](#).

Explanatory information:

The amount of sub-floor ventilation *required* for a building is related to the relative humidity likely to be encountered in that location. [Figure 3.4.1.2](#) shows three broad climatic zones based on the prevailing relative humidity and includes a description of the relative humidity conditions which define each zone. If reliable weather data is available, these descriptions may be useful in determining which zone a particular location is in.

FRAMING

The zones shown in **Figure 3.4.1.2** were determined by analysis of the average relative humidity at 9 am and 3 pm in January and July. The season with the highest relative humidity is used. Generally this will be July for southern Australia and January for northern Australia.

PART 3.4.2 STEEL FRAMING

Appropriate *Performance Requirements*

Where an alternative steel framing system is proposed as an *Alternative Solution* to that described in **Part 3.4.2**, that proposal must comply with—

- (a) *Performance Requirement P2.1.1*; and
- (b) the relevant *Performance Requirements* determined in accordance with **1.0.10**.

A. Acceptable construction manuals

3.4.2.0

Performance Requirement P2.1.1 is satisfied for steel framing if it is designed and constructed in accordance with one of the following:

- (a) Steel structures: AS 4100.
- (b) Cold-formed steel structures: AS/NZS 4600.
- (c) Residential and low-rise steel framing: NASH Standard 'Residential and Low-Rise Steel Framing' Part 1 or Part 2.

Explanatory information:

Design requirements for other materials used in combination with steel framing, including the use of concrete floors, heavy steel support beams etc. are described in **Part 3.11** — Structural design manuals; or **Part 3.4.4** for structural steel members.

B. Acceptable construction practice

3.4.2.1 Application

Compliance with this acceptable construction practice satisfies *Performance Requirement P2.1.1* for steel framing, provided—

- (a) the steel framing is designed and constructed in accordance with—
 - (i) AS/NZS 4600; or
 - (ii) NASH Standard 'Residential and Low-Rise Steel Framing' Part 1 or Part 2; and
- (b) the frame material has a yield stress of not less than 250 MPa.

FRAMING

Explanatory information:

The weight of roof or ceiling insulation, particularly if additional ceiling insulation is used for compliance with the energy efficiency provisions, needs to be considered in the selection of plasterboard, plasterboard fixings and building framing.

3.4.2.2 General

- (a) The steel frame must be protected from corrosion in accordance with the following:
- (i) Where the steel frame is within the building envelope, in locations—
 - (A) more than 300 m from *breaking surf*, or
 - (B) not in a heavy industrial area; or
 - (ii) Where the steel frame is outside the building envelope, in locations—
 - (A) more than 1 km from salt water which is not subject to *breaking surf*, such as a lake or protected bay; or
 - (B) more than 10 km from a coastal area with *breaking surf*, or
 - (C) not in a heavy industrial area,

the steel frame must have a minimum coating class in accordance with AS 1397 of Z275 (275 grams of zinc per square metre) or AZ150 (150 grams of aluminium/zinc per square metre) or AM150 (150 grams of aluminium/zinc/magnesium per square metre).

Explanatory information:

AS 1397 requires the coating mass to be applied to both sides of the framing member. For example, AM150 describes a total aluminium/zinc/magnesium coating mass of 150g/m² obtained from 75g/m² applied to each side.

- (iii) In areas not specified in (i) or (ii), a higher level of corrosion protection is *required*.
- (b) The frame must be permanently electrically earthed on completion of fixing.

Explanatory information:

The steel frame requirements of this Part should be considered in conjunction with steel frame design and construction advice from the manufacturer.

For the purpose of 3.4.2.2, the building *envelope* is deemed to be a space in the building where the steel frame does not have direct contact with the external atmosphere, other than for normal ventilation purposes. Examples of such locations are frames which are clad or lined on both sides or frames in masonry veneer construction. Areas not within the building *envelope* include floor framing members where there is no continuous perimeter sub-floor walling or verandah roof framing members with no ceiling lining.

Cut edges on framing components do not constitute a corrosion problem, as the surface area of the metallic coating on either side of the cut edge is far greater than the surface area of the cut edge itself.

Where hole cutting or cutting of members is *required*, cutting methods that clearly shear or leave clean edges are preferred over those that leave burred edges or swarf.

The adoption of appropriate brick cleaning measures will ensure no damage of any metal or metallic coated components, this would include the shielding of these components during the acid cleaning process. Channels to steel framing should be cleaned of mortar droppings.

FRAMING

Metallic coated steel should not come into contact with green wood containing acidic material or CCA treated timbers unless an impervious non-conductive material is located between the dissimilar elements. The use of kiln or appropriately dried timbers is recommended where contact between the metallic coated steel component and timber is considered.

3.4.2.3 Steel floor framing

The following provisions apply to suspended steel floor framing for single-storey and both floors of two-storey construction:

- (a) The two types of suspended floor systems referred to in 3.4.2.3 are—
 - (i) in-plane systems, such as joist-only systems or systems with integral bearers; and
 - (ii) conventional joist-over-bearer systems (see Tables 3.4.2.1 and 3.4.2.2 for acceptable sizes and spacings).
- (b) When used in ground floor construction, all such systems must be installed on stumps, piers or masonry footings complying with Part 3.2. Conventional flooring can be installed on top of the floor frame.
- (c) Fibre cement packers or similarly durable and compatible materials may be used when packing is necessary under suspended flooring systems and must be at least the width of the member to ensure adequate bearing capacity.

Table 3.4.2.1 SPANS FOR C-SECTION FLOOR JOISTS

SPAN	SECTION	Maximum joist spacing (mm)	
		450	600
		Maximum span (m)	
Single span	C15012	2.7	2.7
	C15015	3.3	3.0
	C15019	3.6	3.3
	C20015	4.5	3.9
	C20019	4.8	4.2
	C20024	5.1	4.5
Continuous span	C15012	4.2	3.0
	C15015	4.5	4.2
	C15019	4.8	4.5
	C20015	5.4	4.8
	C20019	5.7	5.4
	C20024	6.0	5.7

Explanatory information:

The size of C-section steel members are identifiable by their description. For example, a C15012 is 150 mm deep and is made from 1.2 mm thick steel.

FRAMING

Table 3.4.2.2 SPANS FOR C-SECTION BEARERS

Steel Section	SINGLE SPAN					CONTINUOUS SPAN				
	Effective bearer spacing (m)					Effective bearer spacing (m)				
	1.8	2.4	3.0	3.6	4.2	1.8	2.4	3.0	3.6	4.2
	MAXIMUM SPAN OF BEARER (m)					MAXIMUM SPAN OF BEARER (m)				
C15015	2.2	2.1	1.9	1.8	1.7	2.7	2.5	2.4	2.3	2.1
C15019	2.4	2.2	2.0	1.9	1.8	2.9	2.7	2.5	2.4	2.2
C20015	2.9	2.7	2.4	2.1	1.8	3.4	2.7	2.4	2.1	1.8
C20019	3.1	2.9	2.7	2.5	2.4	3.8	3.5	3.3	3.2	3.0
C25019	3.6	3.4	3.2	3.0	2.6	4.6	3.8	3.4	3.0	2.6
C25024	3.9	3.7	3.4	3.3	3.0	4.8	4.6	4.2	4.1	3.8

Note: For the purpose of this Table:

- (a) Loads must be evenly distributed along the member.
- (b) Sections must be stiffened at end supports.

Figure 3.4.2.1

TYPICAL JOIST OVER BEARER FLOORING SYSTEM

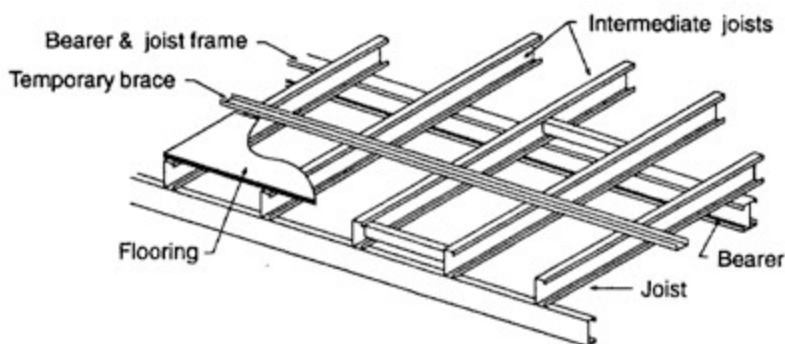

3.4.2.4 * * * * *

This clause has deliberately been left blank.

3.4.2.5 * * * * *

This clause has deliberately been left blank.

3.4.2.6 Installation of services

To maintain the structural integrity of the frame, all ancillary work must be in accordance with the following:

- (a) Service penetrations in floor joists must comply with [Figure 3.4.2.8](#).
- (b) Plumbing pipe-work in steel framed construction must be run in the following ways:

FRAMING

- (i) Pipe-work must be—
 - (A) run through pre-punched service holes in steel studs; and
 - (B) extra holes, where necessary, must be located near the centre-line of each stud provided—
 - (aa) the structural integrity of the member is not reduced; and
 - (bb) the hole is not more than 10% larger than the existing holes.
- (ii) In masonry veneer construction, pipe runs may be located in the *cavity* and fixed to the studs with full pipe saddles and self drilling screws properly protected against galvanic corrosion in accordance with (v).
- (iii) In construction where external cladding is attached directly to the steel stud work, piping can be—
 - (A) installed over the ceiling; or
 - (B) suspended under the floor; or
 - (C) installed in accordance with (i).
- (iv) Plumbing fittings may be attached by—
 - (A) timber or steel noggings fitted between studs to support tap sets, baths and sinks; and
 - (B) where a steel nogging is used, the tap set must be isolated to prevent corrosion by a durable non-corrosive material such as timber, cement sheet etc. (see **Figure 3.4.2.7**).
- (v) Copper and brass pipes and fittings must be prevented from coming into contact with the steel frame by one of the following methods:
 - (A) Where plumbing services pass through service holes, plastic grommets must be snapped into the service hole.

Explanatory information:
The use of grommets also has the effect of securely fixing the pipe to prevent water hammer.

 - (B) In other areas where copper pipes may come into contact with metal framing, they must be lagged or isolated with neoprene sheeting or tape.
- (c) Electrical cables must be—
 - (i) run through pre-punched service holes in steel studs (see **Figure 3.4.2.7**); or
 - (ii) secured to steel framing with—
 - (A) P clips; or
 - (B) plastic ratchet straps; or
 - (C) half saddles fixed with screws or rivets; and
 - (iii) extra holes, where necessary, must comply with (b)(i)(B); and
 - (iv) steel frames must be permanently earthed immediately after the frame is erected; and
 - (v) backing plates for switches and power points should be fixed at the appropriate positions with suitable fasteners. Where it is impractical to fix directly onto

FRAMING

studwork, steel or timber noggings can be fitted between the studs to provide necessary fixing and support.

Figure 3.4.2.7

TYPICAL INSTALLATION AND FIXING OF SERVICES

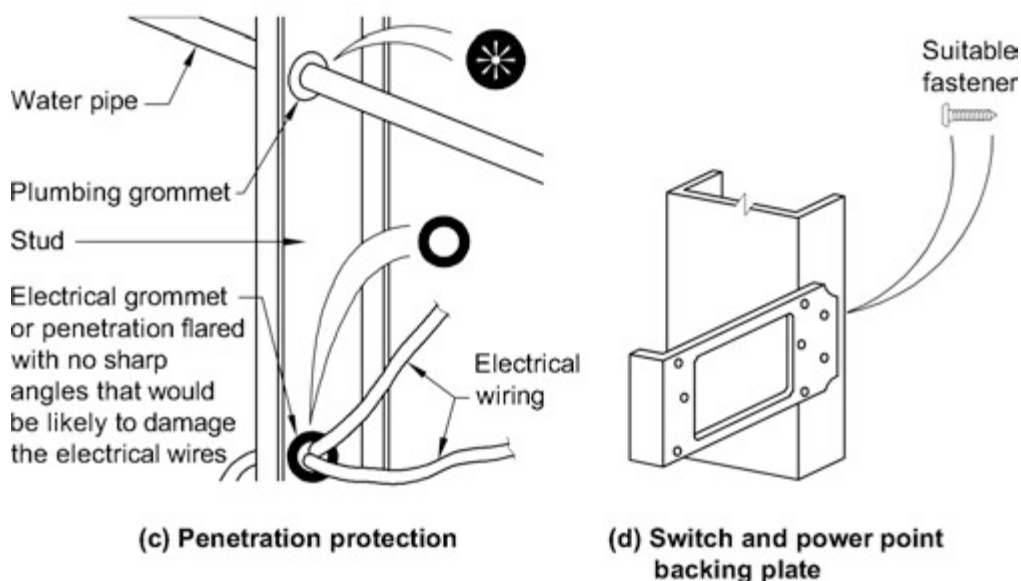
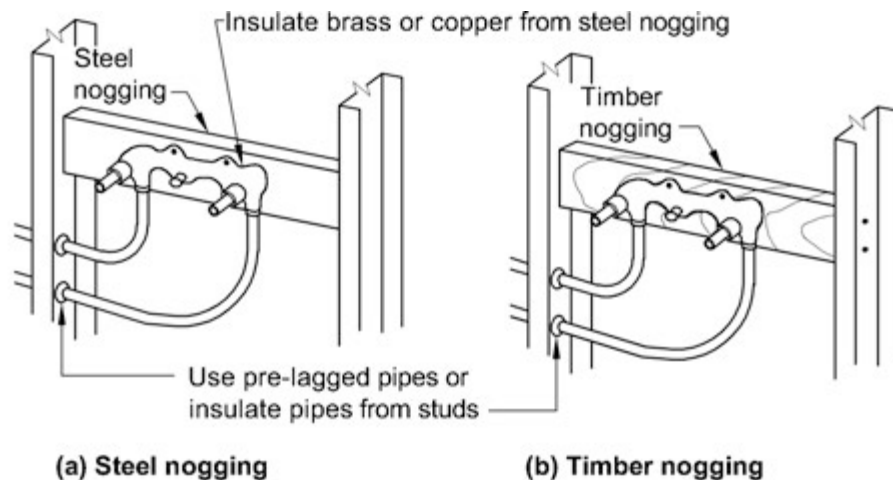

Explanatory information:

There are many different types of steel framing systems available. Each of these systems have unique design and installation requirements. Due to this diversity, there are no generic examples of acceptable construction practice for steel wall and roof framing. Accordingly, the design of these systems must be in accordance with the appropriate acceptable construction manual in [3.4.2.0](#).

FRAMING

Some of the important elements of steel frame design are contained in the following information.

Wall framing

Frames are either in rigid or adjustable form. In the case of rigid frames, minor irregularities in flooring are accommodated by packing.

With adjustable frames, the tensioner assembly on the bracing can usually be adjusted to accommodate these irregularities. After tensioning, bracing straps should be securely fixed to each stud and nogging.

Long runs of external walling may have to be temporarily braced, until the roof members have been fixed. This can be carried out by using lengths of steel, timber or roof battens fixed to the top of the studs and secured to the ground or floor, as temporary props.

Further construction stage bracing may be required to be installed before roof cladding commences. This is required to prevent side sway of the building during construction.

Construction bracing should be provided in the following minimum percentage of *required* vertical bracing:

40% single-storey slab-on-ground buildings;

40% upper-storey of buildings with suspended floors; and

50% lower-storey of two storey construction.

Roof framing

Trusses and rafters are fixed in accordance with the design details. Generally, the roof members are fixed to the wall structure using conventional building methods.

The fixings may incorporate nails, self-drilling screws, bolts and nuts or shear plate connectors. The fixings should be adequate to ensure that a continuous load path exists from the roof to the foundations for all types of loading including uplift, downward and shear loading.

Temporary roof bracing is generally achieved using one run of roof battens along the full length of the house. It is preferable if the run nearest the roof apex is used for this purpose and fixed as each truss is properly positioned. Next, one run of ceiling battens should be positioned and fitted. This should preferably be the batten run nearest the centre of the building.

Where ceiling battens are not used a bottom chord tie should be installed in accordance with the design details.

Wind bracing should be attached when all trusses have been erected and fixed. Generally all gable roofs and long hipped roofs require bracing in the roof plane. The strap bracing is installed similar to wall bracing and runs from the apex of the roof to the *external wall*, over the top of at least three trusses or rafters, at approximately 45° to the *external walls*. The bracing is fixed at the ends, tensioned and fixed to each intermediate truss or rafter.

Connections for steel framing

The following fasteners and connections are acceptable for the assembly and erection of steel framed houses:

Bolts: Bolted connections are used as a means of on-site jointing, particularly where joints are highly loaded and offer a consistent design strength. Bolt design for cold-formed sections is adequately covered in the Australian Standards.

FRAMING

Rivets: Rivetted connections (either pre-drilled or self-piercing) are used for both factory and on-site fabrication and have also been used as elements of proprietary joining systems.

Screw: Self-drilling screws are widely used as a means of connection in almost every aspect of on-site work during the erection of steel framed houses. They are used for connecting wall frame modules, through to attachment of claddings and internal linings.

Adhesives: Adhesives are used in steel framing for attachment of internal linings, including flooring. They are generally used in combination with mechanical fasteners such as self-drilling screws. The screws are primarily used to fasten the linings while the adhesives set, although they continue to act as part of a composite fastening system.

Clinches: Clinching involves the connection of two thicknesses of sheet steel by extruding one sheet into the other using a punch and die, in such a way that the two pieces cannot be subsequently separated. A typical clinched joint used in factory fabrication is usually hydraulically activated whereas clinching systems used on-site are typically pneumatic or electrically driven.

Welds: Welding (typically Mig) has been the most common form of connection during factory assembly for many years. The welded joint strength can vary and the metallic coating is affected in the weld area, the affected area will require post-painting (cold galvanising).

Nails: Hard steel twist nails are used in steel framing for both factory and on-site fabrication. These nails can be used in materials up to 2 mm thick. Nails have also been used for the connection of wall plates to concrete slabs. Where this is done by hand, a timber starter block is normally used. More recently, power actuated nails have been used.

Figure 3.4.2.8

ACCEPTABLE PENETRATIONS TO STEEL FLOOR JOISTS

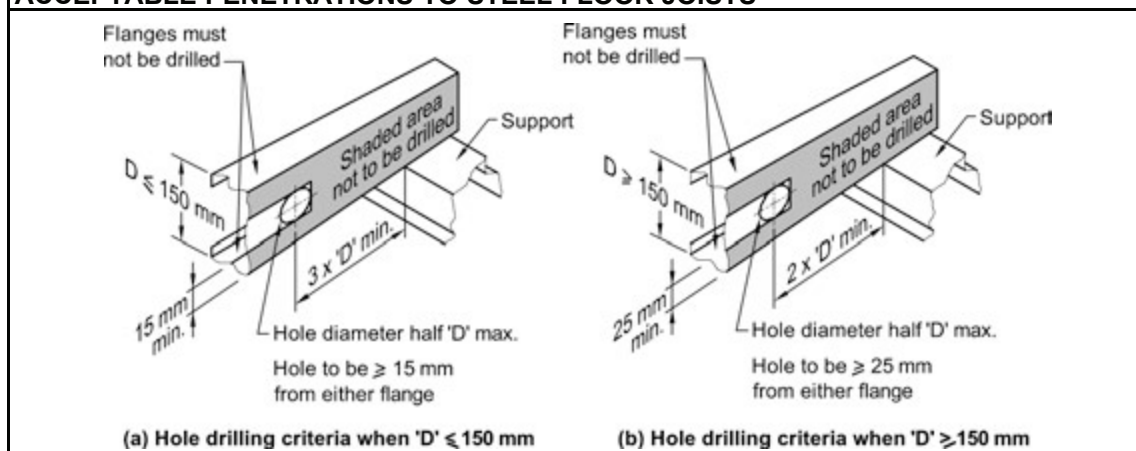

PART 3.4.3 TIMBER FRAMING

Appropriate Performance Requirements

Where an alternative timber framing design is proposed as an *Alternative Solution* to that described in **Part 3.4.3**, that proposal must comply with—

- (a) *Performance Requirement P2.1.1*; and
- (b) the relevant *Performance Requirements* determined in accordance with **1.0.10**.

A. Acceptable construction manuals

3.4.3.0

Performance Requirement P2.1.1 is satisfied for a timber frame if it is designed and constructed in accordance with the following, as appropriate:

- (a) * * * * *
- (b) * * * * *
- (c) * * * * *
- (d) * * * * *
- (e) * * * * *
- (f) * * * * *
- (g) AS 1684.2.
- (h) AS 1684.4.

Explanatory information:

The weight of roof or ceiling insulation, particularly if additional ceiling insulation is used for compliance with the energy efficiency provisions, needs to be considered in the selection of plasterboard, plasterboard fixings and building framing.

STATE AND TERRITORY VARIATIONS

In Queensland after 3.4.3.0(h) insert Qld 3.4.3.0(i) as follows:

Qld 3.4.3.0(i) Timber Species

- (i) Timber Species

In addition to subclauses (a) to (h) above, timber used for structural purposes must be a species scheduled for the appropriate use in Schedules A, B or C of Book 2 of the 'Queensland Government, Department of Agriculture, Fisheries and Forestry - Construction timbers in Queensland, Book 1 and Book 2: Properties and specifications

FRAMING

for satisfactory performance of construction timbers in Queensland - Class 1 and 10 buildings (Houses, carports, garages, greenhouses and sheds)'.

Explanatory information:

1. Design requirements for other materials used in combination with timber framing, including the use of concrete floors, heavy steel support beams etc. are described in [Part 3.11](#) — Structural design manuals; or [Part 3.4.4](#) — Structural steel members.
2. For additional construction requirements in *high wind areas* (i.e. >N3), see [Part 3.10.1](#).

PART 3.4.4 STRUCTURAL STEEL MEMBERS

Appropriate *Performance Requirements*

Where an alternative structural steel member system is proposed as an *Alternative Solution* to that described in Part 3.4.4, that proposal must comply with—

- (a) *Performance Requirement P2.1.1*; and
- (b) the relevant *Performance Requirements* determined in accordance with 1.0.10.

Explanation of Terms

3.4.4

The following terms are used in this Part:

Figure 3.4.4.0
EFFECTIVE MEMBER SPACING FOR STRUCTURAL STEEL BEARERS AND STRUTTING BEAMS

Diagram a. Single spanning rafter or joist

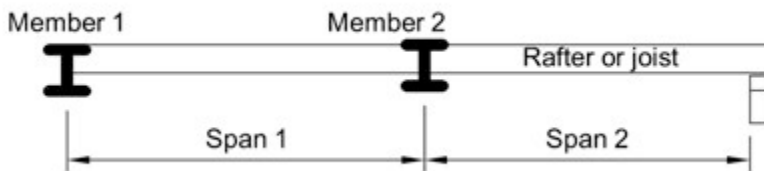

Design member	Member 1	Member 2
Effective member spacing	$0.5 \times \text{Span 1}$	$0.5 \times (\text{Span 1} + \text{Span 2})$

Diagram b. Continuous spanning rafter or joist

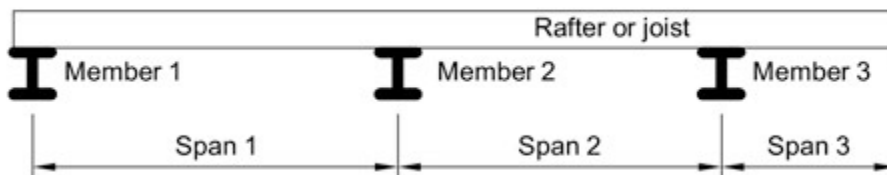

Design member	Member 1	Member 2	Member 3
---------------	----------	----------	----------

FRAMING

Figure 3.4.4.0

EFFECTIVE MEMBER SPACING FOR STRUCTURAL STEEL BEARERS AND STRUTTING BEAMS

Effective member spacing	0.4 x Span 1	0.6 x (Span 1 + Span 2)	0.5 x (Span 2) + Span 3
---------------------------------	--------------	-------------------------	-------------------------

Steel member abbreviations are as follows:

TFB means a tapered flange beam.

UB means a universal beam.

RHS means a rectangular hollow section.

PFC means a parallel flange channel.

TFC means a tapered flange channel.

EA means an equal angle.

UA means an unequal angle.

SHS means a square hollow section.

CHS means a circular hollow section.

A. Acceptable construction manuals**3.4.4.0**

Performance Requirement P2.1.1 is satisfied for structural steel sections if they are designed and constructed in accordance with one of the following:

- (a) Steel structures: AS 4100.
- (b) Cold-formed steel structures: AS/NZS 4600.

Explanatory information:

Design requirements for other materials used in combination with structural steel members are described in [Part 3.4.2](#), [3.4.3](#) or [Part 3.11](#) — Structural design manuals.

B. Acceptable construction practice**3.4.4.1 Application**

- (a) Compliance with this acceptable construction practice satisfies [P2.1.1](#) in respect to structural stability, provided—
 - (i) the building is located in an area with a *design wind speed* of not more than N3; and

FRAMING

Explanatory information:

1. Information on *design wind speeds* for particular areas may be available from the *appropriate authority*.
2. A map indicating cyclonic regions of Australia is contained in **Part 3.10.1**.

- (ii) the first dimension of steel sections is installed vertically; and
- (iii) all loads are uniformly distributed (unless otherwise noted or allowed for); and
- (iv) the building is one for which Appendix A of AS 1170.4 contains no specific earthquake design requirements; and

Explanatory information:

There are certain limitations on the application to domestic structures such as Class 1a and 1b buildings in Appendix A of AS 1170.4. These limitations include building height, roof slope, etc. For additional information refer to Appendix A of AS 1170.4.

- (v) the structural steel member is not subject to snow loads.
- (b) Compliance with **3.4.4.4** satisfies **P2.1.1** in respect to corrosion protection requirements.

3.4.4.2 Structural steel members

- (a) Structural steel members may be used as follows:
- (i) Bearers supporting a timber floor or non-*loadbearing* stud wall — in accordance with **Figure 3.4.4.1**.
 - (ii) Strutting beams supporting roof and ceiling loads — in accordance with **Figure 3.4.4.2**.
 - (iii) Lintels supporting roof, ceiling, frame and timber floor — in accordance with **Figure 3.4.4.3**.
 - (iv) Columns — in accordance with **3.4.4.3**.
- (b) Structural steel members described in this Part must be protected against corrosion in accordance with **3.4.4.4**.
- (c) Joists, bearers and lintels must be restrained from lateral movement or twisting along their length by fixing rafters or joists to the top flange of the member so that it prevents that member from moving laterally.
- (d) End supports for joists, bearers and lintels must transfer loads to the footings and have a bearing distance as follows:
- (i) For single spans, the bearing distance must not be less than the width of the member.
 - (ii) For continuous spans, internal bearing must be not less than two times the width of the member.

FRAMING

Figure 3.4.4.1

BEARER SUPPORTING A TIMBER FLOOR AND NON-LOADBEARING STUD WALL

Bearer connection examples

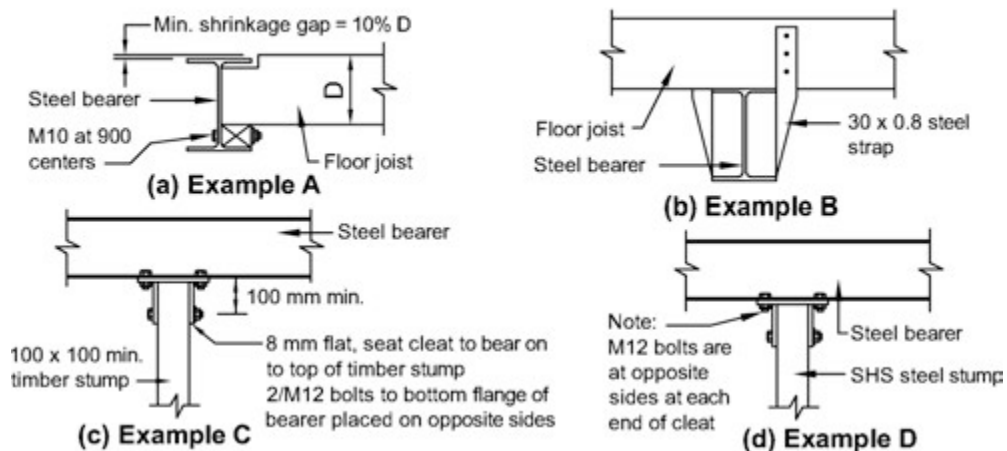

Table a. — Acceptable bearer spans

Steel section	SINGLE SPAN					CONTINUOUS SPAN				
	<i>Effective bearer spacing (m)</i>					<i>Effective bearer spacing (m)</i>				
	1.8	2.4	3.0	3.6	4.2	1.8	2.4	3.0	3.6	4.2
	MAXIMUM SPAN OF BEARER (M)					MAXIMUM SPAN OF BEARER (M)				
125TFB	4.1	3.8	3.6	3.4	3.2	4.7	4.3	3.8	3.5	3.2
180UB16.1	5.1	4.7	4.5	4.3	4.1	5.9	5.5	5.2	5.0	4.7
200UB18.2	5.6	5.2	5.0	4.7	4.6	6.5	6.0	5.7	5.5	5.3
250UB25.7	6.8	6.4	6.0	5.8	5.6	7.9	7.4	7.0	6.7	6.4
250x150x9.0 RHS	7.7	7.1	6.7	6.4	6.2	8.8	8.2	7.8	7.4	7.1
250x150x5.0 RHS	6.8	6.3	5.9	5.7	5.5	7.8	7.2	6.8	6.5	6.3
310UB32.0	7.9	7.3	7.0	6.7	6.4	9.1	8.5	8.1	7.7	7.4
125x75x2.0 RHS	3.1	2.8	2.6	2.5	2.4	4.0	3.7	3.5	3.3	3.1
125x75x3.0 RHS	3.5	3.2	3.0	2.8	2.7	4.4	4.1	3.9	3.7	3.5
150x50x2.0 RHS	3.4	3.1	2.8	2.7	2.5	4.2	3.9	3.7	3.5	3.4
150x50x3.0 RHS	3.7	3.4	3.2	3.0	2.9	4.6	4.3	4.1	3.9	3.7
100TFC	3.2	2.9	2.7	2.6	2.4	3.7	3.2	2.8	2.6	2.4
150PFC	4.8	4.5	4.2	4.0	3.9	5.5	5.1	4.9	4.7	4.5
180PFC	5.4	5.1	4.8	4.6	4.4	6.3	5.9	5.6	5.3	5.1
200PFC	5.9	5.5	5.2	5.0	4.8	6.8	6.3	6.0	5.7	5.5
250PFC	7.2	6.7	6.4	6.1	5.9	8.4	7.8	7.4	7.1	6.8
300PFC	8.1	7.6	7.2	6.9	6.6	9.4	8.8	8.3	8.0	7.7

FRAMING

Figure 3.4.4.1

BEARER SUPPORTING A TIMBER FLOOR AND NON-LOADBEARING STUD WALL**Notes:**

1. Steel is base grade.
2. Load must be evenly distributed along the member.
3. For continuous floor bearers, the variation in span length should not be more than 10%.
4. See 3.4.2.3 for provisions that apply to suspended floors in single-storey and ground floor construction of suspended steel floor frames.
5. Effective bearer spacing is a measure of the width of the load area being supported by the member (see Figure 3.4.4.0).

Figure 3.4.4.2

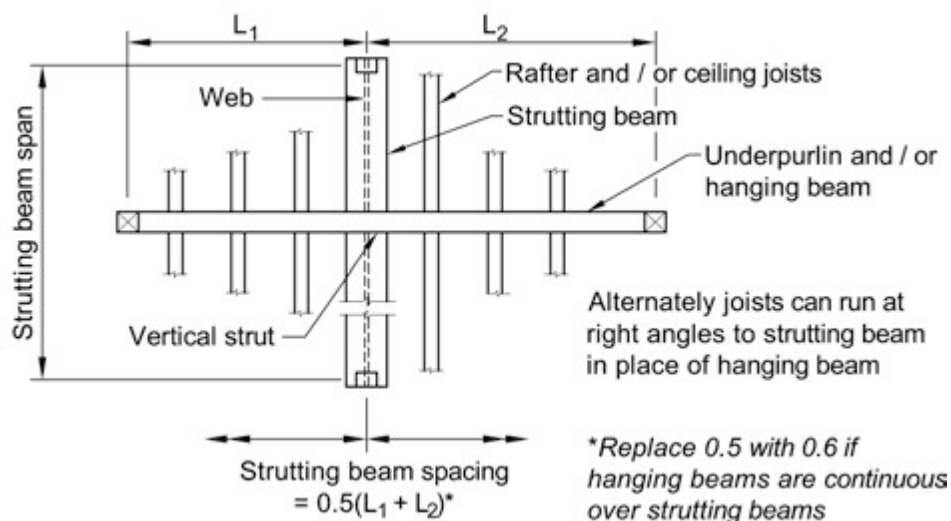
STRUTTING BEAM SUPPORTING A ROOF AND CEILING**Strutting beam application****Table a. — Acceptable strutting beam spans**

Steel section	STEEL SHEET ROOF					TILED ROOF				
	Strutting beam spacing (m)					Strutting beam spacing (m)				
	1.8	2.4	3.0	3.6	4.2	1.8	2.4	3.0	3.6	4.2
	MAXIMUM SPAN OF STRUTTING BEAM (M)					MAXIMUM SPAN OF STRUTTING BEAM (M)				
125TFB	5.7	5.4	5.1	4.9	4.6	4.9	4.6	4.4	4.2	4.1
150UB14.0	6.4	6.0	5.7	5.4	5.1	5.5	5.2	4.9	4.7	4.5
200UB18.2	7.9	7.4	7.1	6.8	6.5	6.9	6.4	6.1	5.8	5.6
250UB31.4	10.0	9.4	9.0	8.7	8.4	8.8	8.2	7.8	7.5	7.2
310UB46.2	11.9	11.3	10.8	10.5	10.1	10.6	10.0	9.5	9.1	8.8

FRAMING

Figure 3.4.4.2

STRUTTING BEAM SUPPORTING A ROOF AND CEILING

100TFC	4.6	4.4	4.2	3.9	3.7	4.0	3.7	3.6	3.4	3.2
150PFC	6.7	6.3	6.0	5.8	5.6	5.8	5.5	5.2	5.0	4.8
200PFC	8.2	7.7	7.4	7.1	6.8	7.2	6.7	6.4	6.1	5.9
250PFC	10.0	9.4	9.0	8.7	8.4	8.8	8.2	7.8	7.5	7.3
300PFC	11.1	10.5	10.1	9.7	9.4	9.8	9.3	8.8	8.4	8.2

Notes:

1. If point load applied, then it should be located within the middle third of the strutting beam span.
2. Top and bottom flanges of strutting beam must be laterally restrained at the loading point.
3. Strutting beam must be tied down at the support points, in the case of steel sheet roofs.
4. Steel is base grade.

Figure 3.4.4.3

LINTELS SUPPORTING ROOF, FRAMES AND TIMBER FLOORS

Lintels supporting roof and floors

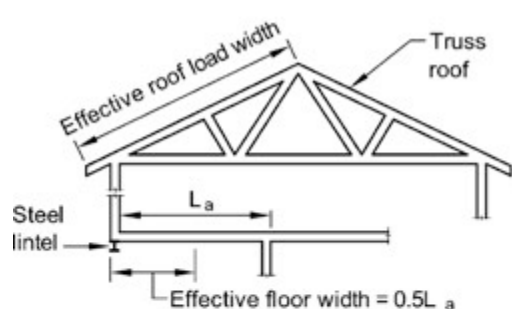

(a) Floor and truss roof

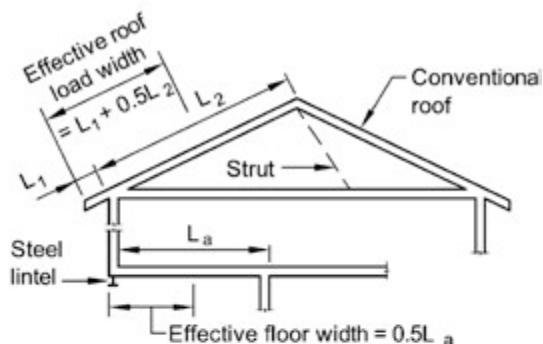

(b) Floor and conventional roof

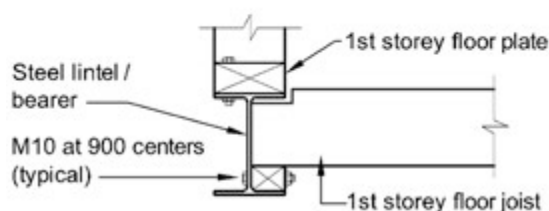

(c) Floor - example A

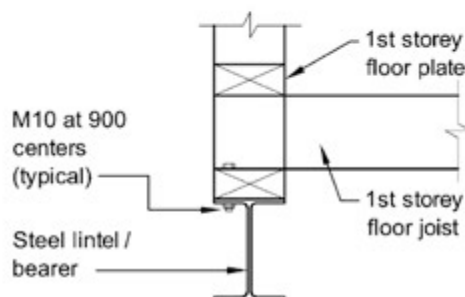

(d) Floor - example B

FRAMING

Figure 3.4.4.3

LINTELS SUPPORTING ROOF, FRAMES AND TIMBER FLOORS

Table a. — Acceptable spans for lintels

Steel section	STEEL SHEET ROOF					TILED ROOF				
	<i>Effective load width (m)</i>					<i>Effective load width (m)</i>				
	1.8	2.4	3.0	3.6	4.2	1.8	2.4	3.0	3.6	4.2
	MAXIMUM SPAN OF LINTEL (M)					MAXIMUM SPAN OF LINTEL (M)				
125TFB	3.7	3.4	3.2	3.0	2.8	3.6	3.3	3.0	2.9	2.7
150UB14.0	4.1	3.9	3.7	3.5	3.3	4.0	3.7	3.5	3.3	3.2
200UB25.4	5.6	5.3	5.0	4.8	4.7	5.4	5.1	4.8	4.6	4.5
250UB31.4	6.6	6.2	5.9	5.7	5.5	6.3	6.0	5.7	5.4	5.2
100TFC	2.8	2.6	2.4	2.3	2.1	2.7	2.5	2.3	2.1	2.0
150PFC	4.4	4.1	3.9	3.7	3.6	4.2	3.9	3.7	3.6	3.4
200PFC	5.4	5.0	4.8	4.6	4.4	5.1	4.8	4.6	4.4	4.2
250PFC	6.6	6.2	5.9	5.7	5.5	6.3	6.0	5.7	5.4	5.3
75x75x5EA	1.3	1.2	1.1	—	—	1.3	1.1	—	—	—
90x90x6EA	1.9	1.6	1.5	1.3	1.2	1.7	1.5	1.4	1.3	1.2
100x100x6EA	2.0	1.8	1.6	1.5	1.4	1.9	1.7	1.5	1.4	1.3
125x75x6UA	2.3	2.0	1.8	1.7	1.5	2.2	1.9	1.7	1.6	1.4
150x100x10UA	3.9	3.6	3.2	2.9	2.7	3.7	3.3	3.0	2.8	2.6

Notes:

1. Top flange of lintel must be laterally restrained at the loading points.
2. Load must be evenly distributed along the member (e.g. joists).
3. Angle lintels — first dimension corresponds to vertical leg (e.g. 100x75x6UA, 100 mm leg is vertical).
4. For lintels supporting masonry walls, see [Part 3.3.3](#).

3.4.4.3 Columns

Columns may support the area provided for in [Table 3.4.4.1](#) provided—

- (a) the effective height of the column is determined in accordance with [Figure 3.4.4.4](#); and
- (b) the floor area to be supported is determined in accordance with [Figure 3.4.4.5](#); and
- (c) the load eccentricity between the centre of the column and the applied vertical loading complies with [Figure 3.4.4.6](#).

FRAMING

Figure 3.4.4.4

DETERMINING EFFECTIVE COLUMN HEIGHT

Diagram a. Column height (H)

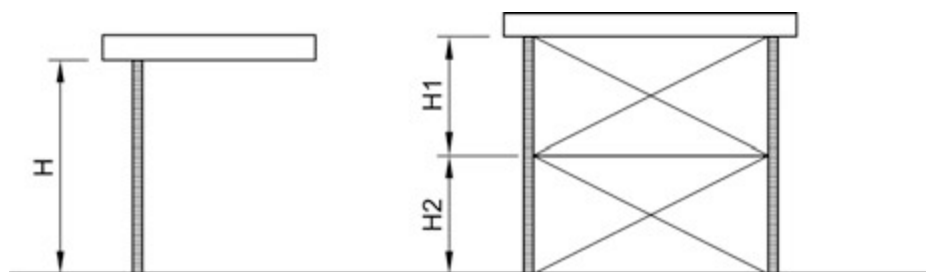

Table a. Column height factor (F1)

BASE DETAIL	BRACING SYSTEM	
	Fully Braced ⁽¹⁾ Construction	Unbraced Construction (cantilever columns) ⁽²⁾
Cast into footing	1.00	2.60
Fixed by bolts to footing or slab	1.20	must not be used
Fixed by intermediate floor or bracing in both directions	1.20	2.60

Notes:

- For the purposes of this Figure, to determine the column effective height, the actual column height (H) in Diagram a. must be multiplied by a column height factor (F1) in Table a.
- H = Distance measured from the top of footing to underside of supported beam or bearer, or between intermediate lateral bracing points.
- The flooring system must be fully braced to footing level by—
 - a combination of column bracing sets, and timber or masonry bracing walls; or
 - the provision of cantilever steel columns only (i.e. no column bracing sets, timber or masonry bracing walls).

FRAMING

Figure 3.4.4.5

DETERMINING FLOOR AREA SUPPORTED

Diagram a.	AREA SUPPORTED BY COLUMNS (Plan view)	Table a.	AREA SUPPORTED BY COLUMNS
		COLUMN	TOTAL AREA SUPPORTED
		C1	$0.375L1 \times 0.375LA$
		C2	$0.625(L1 + L2) \times 0.375LA$
		C3	$0.375L1 \times 0.625(LA + LB)$
		C4	$0.625(L1 + L2) \times 0.625(LA + LB)$
		C5	$0.375L1 \times (L \text{ cant} + 0.5LC)$
		C6	$0.625(L1 + L2) \times (L \text{ cant} + 0.5LC)$

Note: The total area supported depends on the position of the column in the structure as shown in Diagram a. To calculate the correct area supported by a column, match the column's position with those shown in Diagram a. which shows a plan view of a floor and then calculate the total area supported from Table a.

Figure 3.4.4.6

ACCEPTABLE LOAD ECCENTRICITY FOR COLUMNS

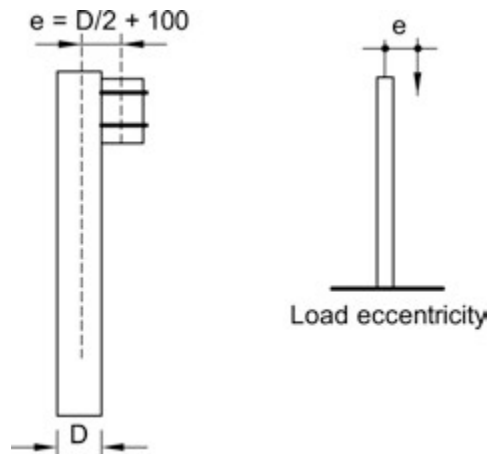

FRAMING

Table 3.4.4.1 COLUMNS

COLUMNS – SUPPORTING TIMBER FLOOR ONLY						
COLUMN EFFECTIVE HEIGHT (mm)		FLOOR AREA SUPPORTED (m ²)				
		5	10	15	20	25
CHS C250	600	60.3 x 3.6	88.9 x 4.0	101.6 x 5.0	114.3 x 5.4	139.7 x 5.0
	1200	60.3 x 4.5	88.9 x 4.0	101.6 x 5.0	114.3 x 5.4	139.7 x 5.0
	1800	60.3 x 4.5	88.9 x 4.0	101.6 x 5.0	114.3 x 5.4	139.7 x 5.0
	2400	60.3 x 4.5	88.9 x 4.0	101.6 x 5.0	114.3 x 5.4	139.7 x 5.0
	3600	76.1 x 3.6	101.6 x 4.0	114.3 x 4.5	139.7 x 5.0	139.7 x 5.0
CHS C350	600	60.3 x 2.9	88.9 x 2.6	101.6 x 3.2	114.3 x 3.6	139.7 x 3.5
	1200	60.3 x 2.9	88.9 x 2.6	101.6 x 3.2	114.3 x 3.6	139.7 x 3.5
	1800	60.3 x 2.9	101.6 x 2.6	114.3 x 3.2	114.3 x 3.6	139.7 x 3.5
	2400	76.1 x 2.3	101.6 x 2.6	114.3 x 3.2	139.7 x 3.0	139.7 x 3.5
	3600	88.9 x 2.6	101.6 x 2.6	114.3 x 3.2	139.7 x 3.0	165.1 x 3.0
SHS C350	600	50 x 50 x 2.5	75 x 75 x 2.5	75 x 75 x 4.0	100 x 100 x 4.0	100 x 100 x 4.0
	1200	65 x 65 x 2.0	75 x 75 x 2.5	75 x 75 x 4.0	100 x 100 x 4.0	100 x 100 x 4.0
	1800	65 x 65 x 2.0	75 x 75 x 3.0	100 x 100 x 3.0	100 x 100 x 4.0	100 x 100 x 4.0
	2400	65 x 65 x 2.0	75 x 75 x 3.0	100 x 100 x 3.0	100 x 100 x 4.0	100 x 100 x 5.0
	3600	65 x 65 x 2.5	75 x 75 x 4.0	100 x 100 x 3.0	100 x 100 x 4.0	100 x 100 x 5.0
SHS C450	600	50 x 50 x 2.0	65 x 65 x 2.5	75 x 75 x 3.0	100 x 100 x 2.8	100 x 100 x 3.3
	1200	50 x 50 x 2.0	65 x 65 x 2.5	75 x 75 x 3.0	100 x 100 x 3.0	100 x 100 x 3.3
	1800	50 x 50 x 2.3	75 x 75 x 2.3	75 x 75 x 3.3	100 x 100 x 3.0	100 x 100 x 3.8
	2400	65 x 65 x 2.0	75 x 75 x 2.5	75 x 75 x 3.5	100 x 100 x 3.0	100 x 100 x 3.8
	3600	65 x 65 x 2.3	100 x 100 x 2.0	100 x 100 x 2.8	100 x 100 x 3.8	100 x 100 x 4.0

FRAMING

Table 3.4.4.1 COLUMNS— continued

COLUMNS — SUPPORTING TILE ROOF ONLY						
COLUMN EFFECTIVE HEIGHT (mm)		ROOF AREA SUPPORTED (m ²)				
		5	10	15	20	25
CHS C250	600	60.3 x 3.6	60.3 x 3.6	76.1 x 3.6	76.1 x 4.5	88.9 x 4.0
	1200	60.3 x 3.6	60.3 x 3.6	76.1 x 3.6	76.1 x 4.5	101.6 x 4.0
	1800	60.3 x 3.6	60.3 x 3.6	76.1 x 3.6	76.1 x 4.5	101.6 x 4.0
	2400	60.3 x 3.6	60.3 x 4.5	76.1 x 3.6	88.9 x 4.0	101.6 x 4.0
	3600	60.3 x 3.6	76.1 x 3.6	76.1 x 4.5	88.9 x 4.0	101.6 x 4.0
CHS C350	600	60.3 x 2.3	60.3 x 2.3	76.1 x 2.3	88.9 x 2.6	101.6 x 2.6
	1200	60.3 x 2.3	60.3 x 2.9	76.1 x 2.3	88.9 x 2.6	101.6 x 2.6
	1800	60.3 x 2.3	60.3 x 2.9	88.9 x 2.6	88.9 x 2.6	101.6 x 2.6
	2400	60.3 x 2.3	76.1 x 2.3	88.9 x 2.6	88.9 x 2.6	101.6 x 2.6
	3600	60.3 x 2.3	76.1 x 2.3	88.9 x 2.6	101 x 2.6	101.6 x 3.2
SHS C350	600	50 x 50 x 2.0	50 x 50 x 2.5	65 x 65 x 2.5	75 x 75 x 2.5	75 x 75 x 3.0
	1200	50 x 50 x 2.0	50 x 50 x 2.5	65 x 65 x 2.5	75 x 75x 2.5	75 x 75 x 3.0
	1800	50 x 50 x 2.0	65 x 65 x 2.0	65 x 65 x 2.5	75 x 75 x 2.5	75 x 75 x 3.0
	2400	50 x 50 x 2.0	65 x 65 x 2.0	65 x 65 x 2.5	75 x 75 x 2.5	75 x 75 x 4.0
	3600	50 x 50 x 2.5	65 x 65 x 2.5	75 x 75 x 2.5	75 x 75 x 3.0	75 x 75 x 4.0
SHS C450	600	50 x 50 x 1.6	50 x 50 x 2.0	65 x 65 x 2.0	65 x 65 x 2.3	65 x 65 x 2.8
	1200	50 x 50 x 1.6	50 x 50 x 2.0	65 x 65 x 2.0	65 x 65 x 2.3	65 x 65 x 2.8
	1800	50 x 50 x 1.6	65 x 65 x 1.6	65 x 65 x 2.0	65 x 65 x 2.5	75 x 75 x 2.5
	2400	50 x 50 x 1.6	50 x 50 x 2.5	65 x 65 x 2.3	75 x 75 x 2.3	75 x 75 x 2.8
	3600	50 x 50 x 2.0	65 x 65 x 2.0	75 x 75 x 2.3	100 x 100 x 2.0	100 x 100 x 2.3

Note: Tabulated values are the column sections to be used.

3.4.4.4 Corrosion protection

Structural steel members that are not built into a masonry wall must be protected against corrosion in accordance with [Table 3.4.4.2](#).

FRAMING

Table 3.4.4.2 PROTECTIVE COATINGS FOR STEELWORK

ENVIRONMENT	LOCATION	MINIMUM PROTECTIVE COATING	
		General structural steel members	
MODERATE More than 1 km from <i>breaking surf</i> or more than 100 m from salt water not subject to <i>breaking surf</i> or non-heavy industrial areas	INTERNAL	No protection required in a permanently dry location ^{Note 6}	
	EXTERNAL	Option 1. 2 coats alkyd primer Option 2. 2 coats alkyd gloss Option 3. Hot dip galvanise 300 g/m ² min Option 4. Hot dip galvanise 100 g/m ² min plus— (a) 1 coat solvent based vinyl primer; or (b) 1 coat vinyl gloss or alkyd.	
SEVERE Within 1 km from <i>breaking surf</i> or within 100 m of salt water not subject to <i>breaking surf</i> or heavy industrial areas	INTERNAL	Option 1. 2 coats alkyd primer Option 2. 2 coats alkyd gloss	
	EXTERNAL	Option 1. Inorganic zinc primer plus 2 coats vinyl gloss finishing coats Option 2. Hot dip galvanise 300 g/m ² Option 3. Hot dip galvanise 100 g/m ² min plus— (a) 2 coats solvent based vinyl primer; or (b) 2 coats vinyl gloss or alkyd.	

Notes:

1. Heavy industrial areas means industrial environments around major industrial complexes. There are only a few such regions in Australia, examples of which occur around Port Pirie and Newcastle.
2. The outer leaf and *cavity* of an external masonry wall of a building, including walls under open carports are considered to be external environments. A part of an internal leaf of an external masonry wall which is located in the roof space is considered to be in an internal environment.
3. Where a paint finish is applied the surface of the steel work must be hand or power tool cleaned to remove any rust immediately prior to painting.
4. All zinc coatings (including inorganic zinc) require a barrier coat to stop conventional domestic enamels from peeling.
5. Refer to the paint manufacturer where decorative finishes are required on top of the minimum coating specified in the table for protection of the steel against corrosion.

FRAMING

Table 3.4.4.2 PROTECTIVE COATINGS FOR STEELWORK — continued

ENVIRONMENT	LOCATION	MINIMUM PROTECTIVE COATING
		General structural steel members
6.	Internal locations subject to moisture, such as in close proximity to kitchen or bathroom exhaust fans are not considered to be in a permanently dry location and protection as specified for external locations is <i>required</i> .	
7.	For applications outside the scope of this table, seek specialist advice.	

PART **3.5**

ROOF AND WALL CLADDING

- 3.5.1** Roof Cladding
- 3.5.2** Gutters and Downpipes
- 3.5.3** Wall Cladding

PART 3.5 CONTENTS

PART 3.5 ROOF AND WALL CLADDING

Explanatory Information

3.5.1 Roof cladding

- 3.5.1.0 Acceptable construction manuals
- 3.5.1.1 Application
- 3.5.1.2 Roof tiling
- 3.5.1.3 Metal sheet roofing

3.5.2 Gutters and downpipes

- 3.5.2.0 Acceptable construction manuals
- 3.5.2.1 Application
- 3.5.2.2 Materials
- 3.5.2.3 Selection of guttering
- 3.5.2.4 Installation of gutters
- 3.5.2.5 Downpipes — size and installation

3.5.3 Wall Cladding

- 3.5.3.0 Acceptable construction manual
- 3.5.3.1 Application
- 3.5.3.2 Timber weatherboard cladding
- 3.5.3.3 Wall cladding boards
- 3.5.3.4 Sheet wall cladding
- 3.5.3.5 Eaves and soffit linings
- 3.5.3.6 Flashings to wall openings

PART 3.5

EXPLANATORY INFORMATION

Explanatory information:

These provisions relate to installing systems to waterproof roofs, walls and wall openings.

It should be noted that other construction methods may be used to achieve the same results as specified in this Part provided they comply with the appropriate *Performance Requirement*.

PART 3.5.1 ROOF CLADDING

Appropriate *Performance Requirements*

Where an alternative roof cladding is proposed as an *Alternative Solution* to that described in **Part 3.5.1**, that proposal must comply with—

- (a) *Performance Requirement P2.1.1*; and
- (b) *Performance Requirement P2.2.2*; and
- (c) the relevant *Performance Requirements* determined in accordance with **1.0.10**.

A. Acceptable construction manuals

3.5.1.0

Performance Requirements P2.1.1 and *P2.2.2* are satisfied for roof cladding if it complies with one of the following:

- (a) Roofing tiles: AS 2049 and AS 2050.
- (b) Metal roofing: AS 1562.1.
- (c) Plastic sheet roofing: AS/NZS 4256 Parts 1, 2, 3 and 5; and AS/NZS 1562.3.
- (d) Corrugated fibre-reinforced cement sheet roofing: AS/NZS 1562.2.
- (e) Asphalt shingles: ASTM D3018-90.
- (f) Pliable membrane and underlay: AS/NZS 4200 Parts 1 and 2.

B. Acceptable construction practice

3.5.1.1 Application

Compliance with this acceptable construction practice satisfies *Performance Requirements P2.1.1* and *P2.2.2* for roof cladding, provided—

- (a) the building is located in an area with a *design wind speed* of not more than N3; and

Explanatory information:

1. Information on *design wind speeds* for particular areas may be available from the *appropriate authority*.
2. A map indicating cyclonic regions of Australia is contained in **Part 3.10.1**.

- (b) roof tiles are installed in accordance with **3.5.1.2**; and

ROOF AND WALL CLADDING

- (c) metal sheet roofing is installed in accordance with 3.5.1.3.

3.5.1.2 Roof tiling

- (a) Roof tiles, complying with AS 2049, must be installed, fixed and flashed in accordance with the relevant provisions of this Part.
- (b) Roof tiles on roofs with a pitch of not less than 15 degrees and not more than 35 degrees must be fixed in accordance with Figure 3.5.1.1.
- (c) Fixings for roof battens and batten sizes must comply with Part 3.4.3.
- (d) All tiled roof flashings, ridge and hip tiles must be installed in accordance with Figure 3.5.1.2.
- (e) Lead flashings must not be used on any roof that is part of a potable water catchment area.
- (f) Sarking must be installed under tiled roofs in accordance with Table 3.5.1.1b.
- (g) Where sarking is installed, an anti-ponding device/board must—
- (i) be provided—
 - (A) on roofs with pitches of less than 20°; and
 - (B) on all roof pitches where there are no eaves overhang; and
 - (ii) be fixed along the eaves line from the top of the fascia back up the rafter with a clearance of approximately 50 mm below the first batten.
- (h) All water discharged from a gutter/valley or downpipe onto a tiled roof must be prevented from inundating or penetrating the tiling by the provision of—
- (i) a spreader pipe; or
 - (ii) a flashing; or
 - (iii) sarking installed with a minimum width of 1800 mm either side from the point of discharge and extended down to the eaves gutter.

Figure 3.5.1.1

MINIMUM MECHANICAL FASTENING FOR TILES AND ANCILLARIES

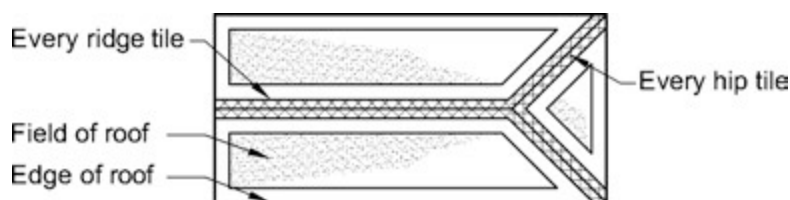

DESIGN WIND SPEED NOT MORE THAN N3

ROOF AND WALL CLADDING

Wind classification	Tile installation		Ancillary installation
	Edge of roof	Field of roof	Ridge, hip and barge tiles
less than N2	Mechanically fasten each full tile in second course and then every second tile in every course, or every tile in each alternative course.		Mechanically fasten each tile
N2—N3	Mechanically fasten each full tile in second course	Mechanically fasten each second full tile in every course	

Notes:

- Mechanical fastening can be achieved with either nails, screws, clips or flexible pointing materials complying with AS 2050.
- For the purposes of this Figure, "edge of roof" is a 1.2 m wide band bounded by the eaves, ridge, hips and barge measured towards the "field of roof".

Figure 3.5.1.2

TILED ROOF FLASHING AND OTHER DETAILS

Diagram a. Mechanical fastening-ridge clip (Also see [Figure 3.5.1.1](#))

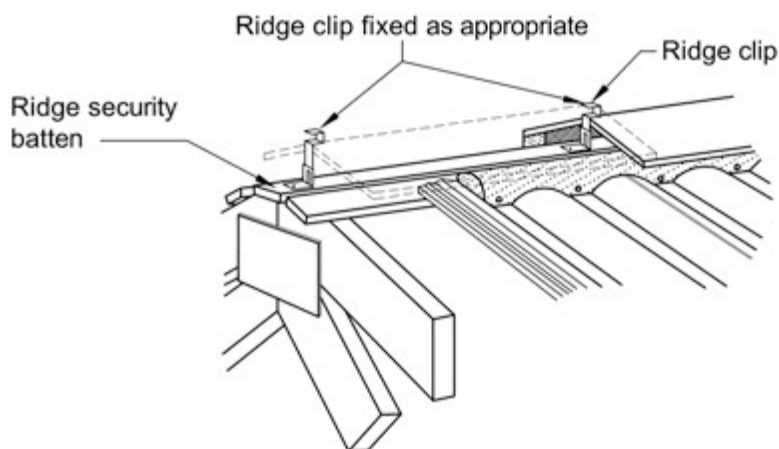

ROOF AND WALL CLADDING

Figure 3.5.1.2

TILED ROOF FLASHING AND OTHER DETAILS

Diagram b. Dry valley

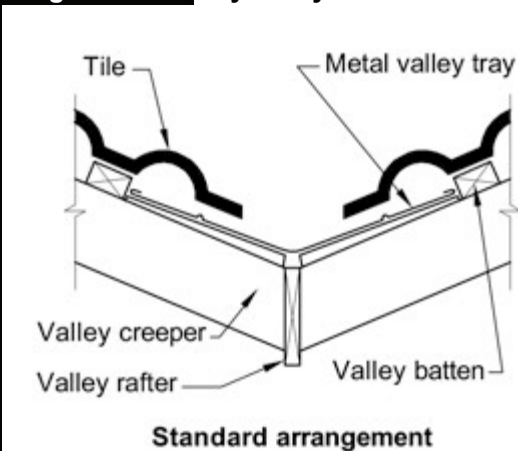

Diagram c. Bedded and pointed valley

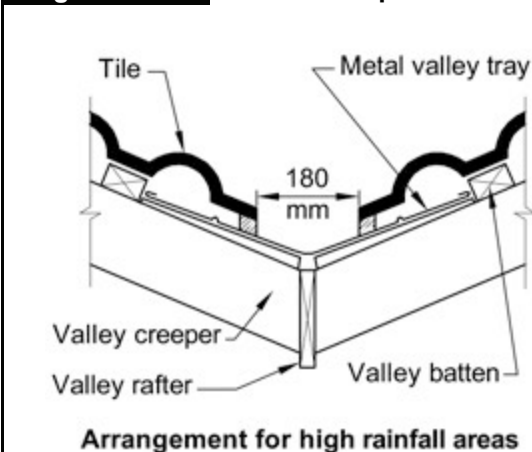
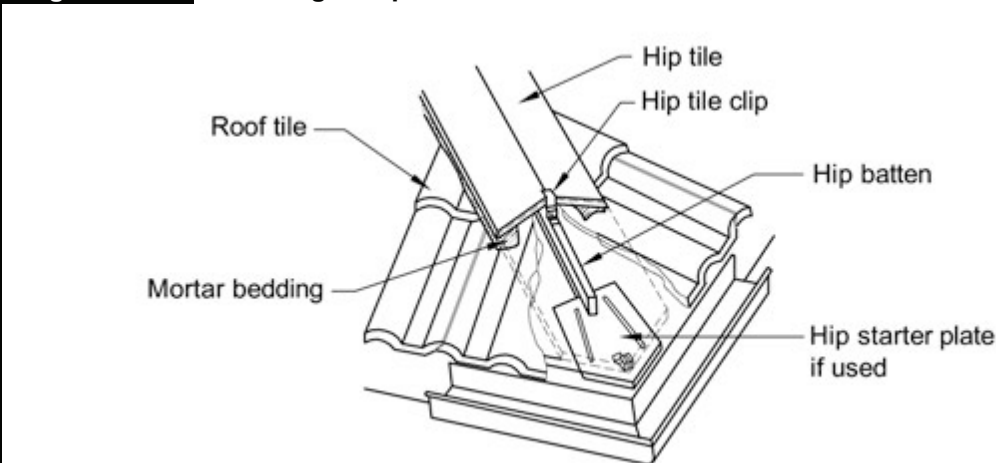

Diagram d. Fastening of hip tiles



3.5.1.3 Metal sheet roofing

- (a) The design and installation of metal sheet roofing must comply with the relevant provisions of this Part.
- (b) Metal sheet roofing must be protected from corrosion in accordance with [Table 3.5.1.1a](#).

Table 3.5.1.1a ACCEPTABLE CORROSION PROTECTION FOR SHEET ROOFING

ENVIRONMENT	LOCATION	MINIMUM METAL COATING IN ACCORDANCE WITH AS 1397	
		Metallic coated steel	Metallic and organic coated steel

ROOF AND WALL CLADDING

Table 3.5.1.1a ACCEPTABLE CORROSION PROTECTION FOR SHEET ROOFING — continued

Low (Mild steel corrosion rate 1.3 to 25 µm/y)	Typically remote inland areas.	Z450 galvanised or AZ150 aluminium/zinc	Z275 galvanised or AZ150 aluminium/zinc
	Typically more than 1 km from sheltered bays.	or AM125 aluminium/zinc/ magnesium	or AM100 aluminium/zinc/ magnesium
Medium (Mild steel corrosion rate 25 to 50 µm/y)	Typically more than 1 km from <i>breaking surf</i> or aggressive industrial areas.	Z450 galvanised or AZ150 aluminium/zinc	Z275 galvanised or AZ150 aluminium/zinc
	Typically more than 50 m from sheltered bays.	or AM125 aluminium/zinc/ magnesium	or AM100 aluminium/zinc/ magnesium
High (Mild steel corrosion rate 50 to 80 µm/y)	Typically more than 200 m from <i>breaking surf</i> or aggressive industrial areas.	AZ150 aluminium/zinc or AM125 aluminium/zinc/ magnesium	AZ150 aluminium/zinc or AM100 aluminium/zinc/ magnesium
	Typically within 50 m from sheltered bays.	AZ200 aluminium/zinc or AM150 aluminium/zinc/ magnesium	AZ200 aluminium/zinc or AM150 aluminium/zinc/ magnesium
Very High (Mild steel corrosion rate 80 to 200 µm/y)	Typically extends from 100 m inland from <i>breaking surf</i> to 200 m inland from <i>breaking surf</i> , or within 200 m of aggressive industrial areas.	Not suitable	AZ200 aluminium/zinc or AM150 aluminium/zinc/ magnesium
	Typically within 100 m of <i>breaking surf</i>	Not suitable	Not suitable

ROOF AND WALL CLADDING

Table 3.5.1.1a ACCEPTABLE CORROSION PROTECTION FOR SHEET ROOFING — continued

Notes:	
1.	Low — remote inland includes dry rural areas remote from the coast or sources of pollution. Many areas of Australia beyond at least 50 km from the sea are in this category, including most cities and towns such as Canberra, Ballarat, Toowoomba, Alice Springs and some suburbs of cities on sheltered bays such as Melbourne, Hobart, Brisbane and Adelaide that are more than 1 km from the sea. However each of these have many exceptions which are in more corrosive categories.
2.	Medium — urban inland, coastal or industrial typically coastal areas with low salinity around sheltered bays, such as Port Phillip Bay. This extends from about 50 m from the shoreline to a distance of about 1 km inland but seasonally or in semi-sheltered bays extends 3 to 6 km inland. Along ocean front areas with <i>breaking surf</i> and significant salt spray, it extends from 1 km inland to about 10 to 50 km depending on wind direction and topography. Much of the metropolitan areas of Wollongong, Sydney, Newcastle, Perth and the Gold Coast are in this category. This can extend to 30 to 70 km inland in South Australia while on some evidence, other southern Australian coastal zones are in this, or a more severe category. This also includes urban and industrial areas with low pollution and for several kilometres around large industries such as steel works and smelters.
3.	High typically occurs on the coast around sheltered bays. Category high extends up to 50 m inland from the shoreline. In areas of rough seas and surf it extends from several hundred metres to about 1 km inland. As with other categories the extent depends on wind, wave action and topography. The category will also be found inside industrial plants and can influence a distance of 1.5 km down wind of the plant.
4.	Very high is typical of offshore conditions and is found on the beachfront in regions of rough seas and surf beaches. It can extend inland for several hundred metres. It is also found in aggressive industrial areas with a pH of less than 5.
5.	All locations described in the table contain variations of greater corrosion severity. If significant, this must be addressed by designing for the most severe environment.
6.	In locations where metallic coatings are not a suitable form of corrosion protection, the roof sheeting must be of a type which has been designed and manufactured for such environments.

Table 3.5.1.1b SARKING REQUIREMENTS FOR TILED ROOFS

Roof—degrees of pitch	Maximum rafter length without sarking (mm)
≥ 18 < 20	4500
≥ 20 < 22	5500
≥ 22	6000

Note: The maximum rafter length is measured from the topmost point of the rafter downwards. Where the maximum rafter length is exceeded, sarking must be installed over the remainder of the rafter length.

- (c) Where different metals are used in a roofing system, including cladding, *flashings*, fasteners, downpipes etc, they must be compatible with each other (to prevent corrosion due to an adverse chemical reaction) as described in [Table 3.5.1.2](#) and—
- (i) no lead materials can be used upstream from zinc-aluminium coated materials; and

ROOF AND WALL CLADDING

- (ii) no copper materials can be used upstream from galvanised coated materials.
- (d) Metal sheet roofing must—
- (i) be fixed at spacings in accordance with [Figure 3.5.1.5](#); and
 - (ii) use fastening devices made of a compatible metal to the roofing in accordance with [3.5.1.3\(c\)](#); and
 - (iii) when using both clipped and pierced fastening systems—
 - (A) employ an anti-capillary feature in the side lap of the sheet, to prevent capillary action drawing moisture into the lap and allowing the lap to drain (achieved by not over tightening the sheet fixings, see [Figure 3.5.1.3](#)); and
 - (B) wherever possible have the sheets laid so that the side lap is facing away from prevailing weather.

Table 3.5.1.2 ACCEPTABILITY OF CONTACT BETWEEN DIFFERENT ROOFING MATERIALS

CLADDING MATERIAL	ACCESSORY OR FASTENER MATERIAL							
	Stainless steel		Zinc-coated steel and Zinc		Zinc/Aluminium coated steel or aluminium/zinc (AZ) and aluminium/zinc/magnesium (AM) coated steel		Lead	
	Atmosphere Classification (L = Low, M – VH = Medium to Very High as per Table 3.5.1.1a)							
	M-VH	L	M-VH	L	M-VH	L	M-VH	L
Copper and copper alloys	No	Yes	No	No	No	No	No	Yes
Stainless steel (300 series)	Yes	Yes	No	No	No	No	No	Yes
Zinc-coated steel and zinc	No	Yes	Yes	Yes	Yes	Yes	No	Yes
Zinc/aluminium coated steel	No	Yes	Yes	Yes	Yes	Yes	No	No
Aluminium/zinc (AZ) and aluminium/zinc/magnesium (AM) coated steel	No	Yes	Yes	Yes	Yes	Yes	No	No
Lead	Yes	Yes	No	Yes	No	No	Yes	Yes
Notes:								
1. No — means the metal cannot be used in association with the other metal.								
2. Yes — means the metal can be used in association with the other metal.								

ROOF AND WALL CLADDING

Figure 3.5.1.3

SIDE LAPPING FASTENING DETAIL

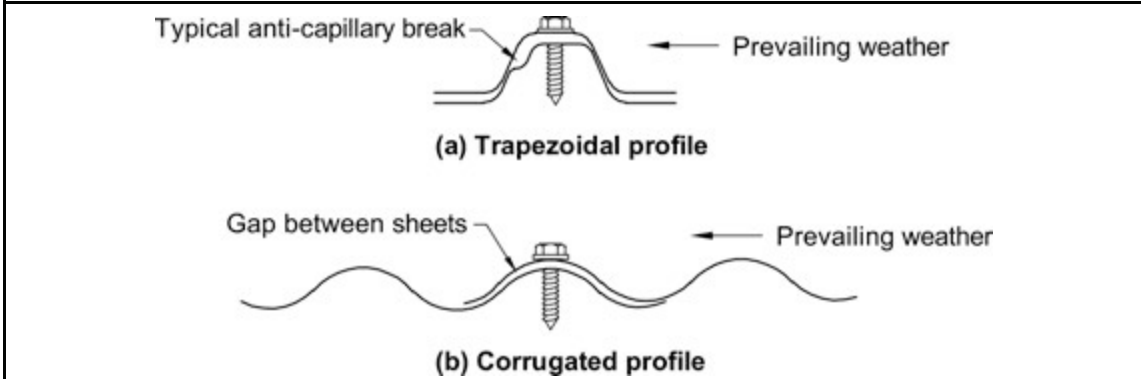

- (e) Sheets must be—
- (i) laid wherever possible using complete lengths from ridge to eaves; or
 - (ii) where a complete length cannot be laid—
 - (A) each run should be laid in specific sequence (see [Figure 3.5.1.4](#)) from bottom to top before moving on to the next run; and
 - (B) the distance for end lapping where sheets meet is—
 - (aa) for roof slopes between 5–15 degrees (1:12–1:4) — a lap of 200 mm; and
 - (bb) for roof slopes above 15 degrees (1:4) — a lap of 150 mm; and
 - (iii) stop ended (i.e. each valley turned up 60 degrees) at the ridge line of each length.

Figure 3.5.1.4

SHEET LAYING SEQUENCE

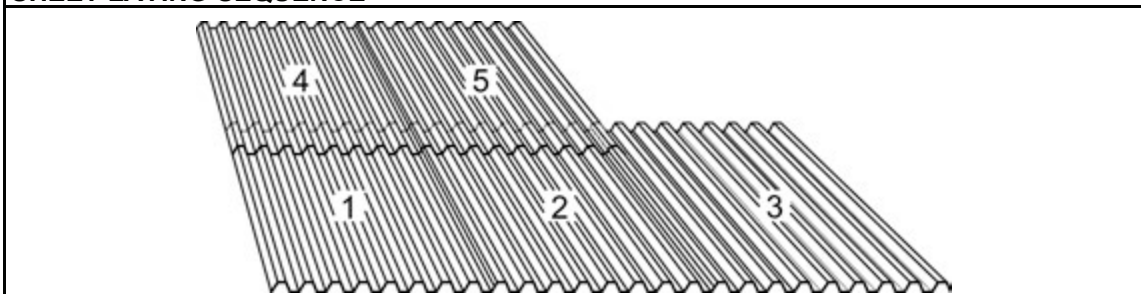

- (f) Metal sheet roofing must comply with the pitch and span limitations between roofing supports as shown in [Figure 3.5.1.5](#).

ROOF AND WALL CLADDING

Figure 3.5.1.5

MAXIMUM SPAN AND FIXING FOR METAL SHEET ROOFING

Diagram a. Typical profiles — Pitch is appropriate for a sheet run up to 25 m in length

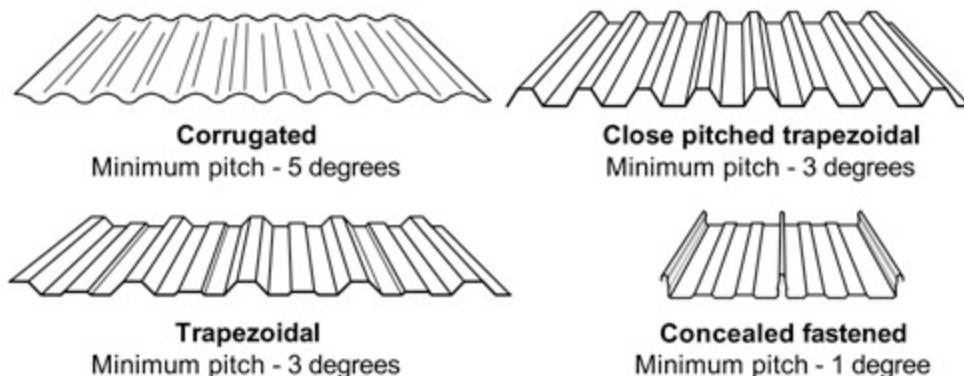

Note: The end span of some trapezoidal roofing systems may need to be reduced to 1.5 m (see proprietary information).

Diagram b. End and internal roof spans

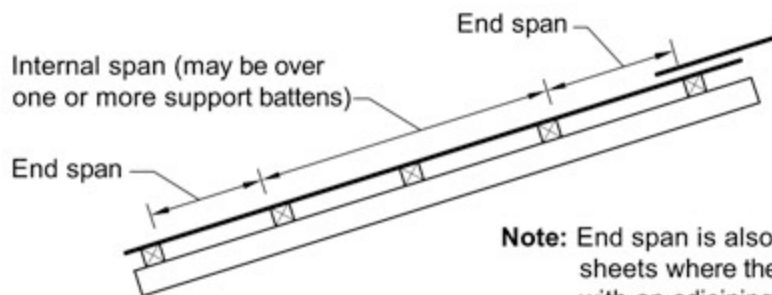

Note: End span is also the end of sheets where they overlap with an adjoining sheet.

PROFILE	BASE METAL THICKNESS (mm)	END SPAN (mm)	INTERNAL SPAN (mm)	FIXING (crest fastening)	
				END SPAN	INTERNAL SPANS
Corrugated	0.42	950	1200	Every second rib	Every third rib
Close pitched trapezoidal	0.42	1900	2400	Every rib	Every second rib
Trapezoidal	0.42	1350	1700	Every rib	
Concealed fasteners	0.48	1800	2100	Every rib	

- (g) Sheet metal roof *flashings* and cappings must comply with the following:
- Roof *flashings* and cappings must be purpose made, machine-folded sheet metal sections of materials compatible with all up and downstream metal roof covering materials in accordance with 3.5.1.3(c).

ROOF AND WALL CLADDING

- (ii) The type of fasteners for *flashings* and cappings must comply with 3.5.1.3(d).
- (iii) The fastener fixing frequency for transverse *flashings* and cappings must comply with Table 3.5.1.3.

Table 3.5.1.3 FASTENER FREQUENCY FOR TRANSVERSE FLASHINGS AND CAPPINGS

ROOF TYPE	FIXING FREQUENCY	FASTENER TYPE
Concealed fastened roofs	Every rib	Rivets and self drilling screws
Pierced fastened roofs	Every 2nd rib	Self drilling screws or rivets
Corrugated roofs	Every 4th rib	Self drilling screws or rivets

- (iv) Joints in *flashing* and cappings must be not less than 25 mm, fastened at intervals not more than 40 mm and lapped in the direction of the fall of the roof.
- (v) Wall and step *flashings* must be fastened into masonry walls with galvanised or zinc/aluminium sheet metal wedges at each end of each length and at intermittent intervals of not more than 500 mm and must overlap by not less than 75 mm in the direction of flow.
- (vi) Lead *flashings* must not be used with prepainted steel or zinc/aluminium steel or on any roof if the roof is part of a potable (drinking) water catchment area.
- (vii) Anti capillary breaks must be installed in accordance with Figure 3.5.1.6 and be—
 - (A) for flat surfaces — 10 mm/30 degree fold; and
 - (B) all other surfaces — 10 mm/90 degree or 135 degree fold.

Figure 3.5.1.6

ANTI CAPILLARY BREAKS

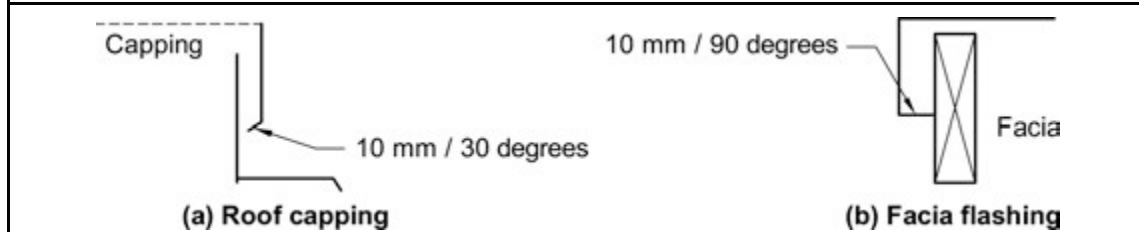

- (viii) Acceptable *flashing* configurations are shown in Figure 3.5.1.7.

ROOF AND WALL CLADDING

Figure 3.5.1.7

ACCEPTABLE FLASHING DETAILS

Diagram a. Parapet flashing

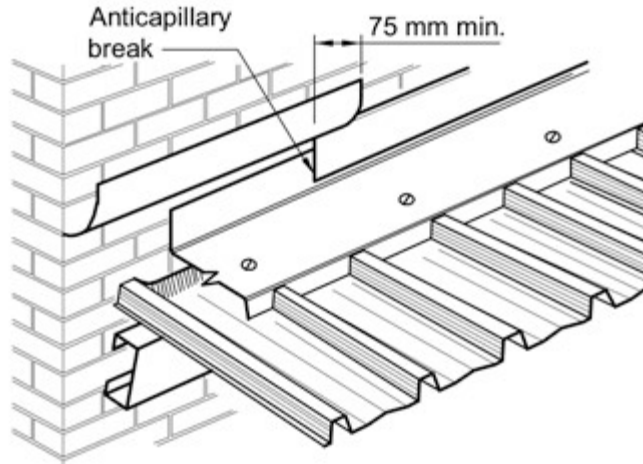
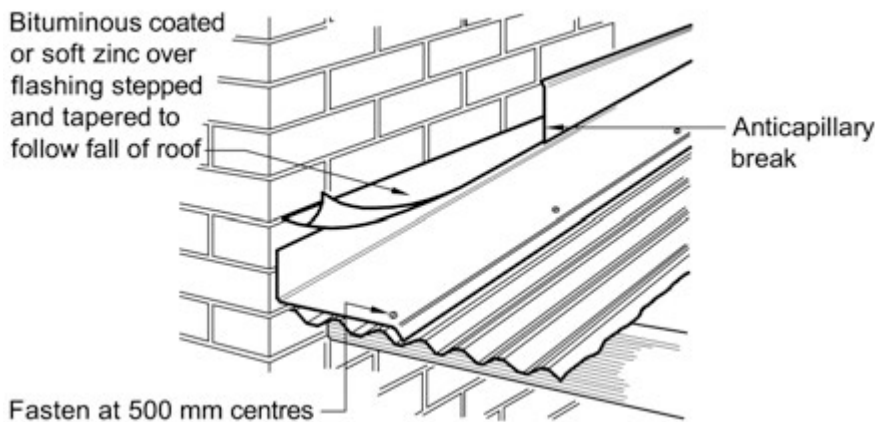

Diagram b. Parapet and end wall flashing



- (h) *Flashing* of penetrations must comply with the following:
- (i) Collar *flashings* must permit the total drainage of the area above the penetration.
 - (ii) On the completion of installation, the roof structure must be restored to its original strength by installing roof trimmers and soaker supports as necessary.
 - (iii) The type of fasteners for *flashings* and cappings must comply with [3.5.1.3\(d\)](#).
 - (iv) Lead *flashings* must not be used with prepainted steel or zinc/aluminium steel or on any roof if the roof is part of a potable water catchment area.
 - (v) Acceptable *flashings* for penetrations are shown in [Figure 3.5.1.8](#).
 - (vi) Clearance for heating appliance roof support members must be in accordance with [Part 3.7.3](#).

ROOF AND WALL CLADDING

Figure 3.5.1.8

TYPICAL ROOF PENETRATION FLASHING DETAILS

Diagram a. PVC aprons

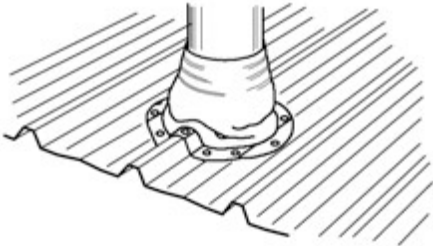

Diagram b. Collar flashings

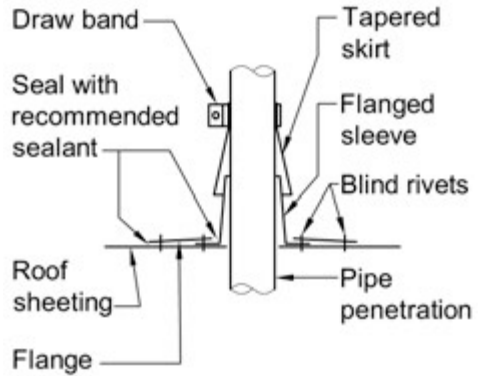
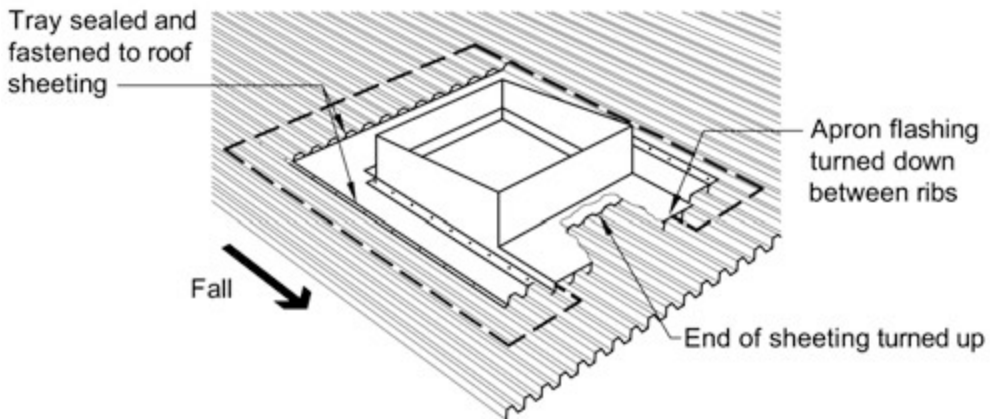

Diagram c. Large penetrations — using apron



PART 3.5.2 GUTTERS AND DOWNPIPES

Appropriate *Performance Requirements*:

Where an alternative gutter and downpipe system is proposed as an *Alternative Solution* to that described in **Part 3.5.2**, that proposal must comply with—

- (a) *Performance Requirement P2.2.1*; and
- (b) the relevant *Performance Requirements* determined in accordance with **1.0.10**.

A. Acceptable construction manuals

3.5.2.0

Performance Requirement P2.2.1 is satisfied for gutters and downpipes if they are designed and constructed in accordance with one of the following:

- (a) AS/NZS 3500.3.
- (b) Section 5 of AS/NZS 3500.5.

B. Acceptable construction practice

3.5.2.1 Application

Compliance with this acceptable construction practice satisfies *Performance Requirement P2.2.1* for gutters and downpipes provided—

- (a) the roof drainage system is connected to a stormwater drainage system that complies with **Part 3.1.2**; and
- (b) the roof drainage system is designed so that any overflow during heavy rain periods is prevented from flowing back into the building.

Explanatory information:

1. The requirement to install drainage systems from roofs and sub-soil drains should be confirmed with the *appropriate authority*. These provisions need only be applied when drainage systems are necessary.
2. Information on drainage requirements outside the allotment can be obtained from the *appropriate authority*.

3.5.2.2 Materials

Gutters, downpipes and *flashings* must—

ROOF AND WALL CLADDING

- (a) be manufactured in accordance with AS/NZS 2179.1 for metal; and
- (b) be manufactured in accordance with AS 1273 for UPVC components; and
- (c) be compatible with all upstream roofing materials in accordance with 3.5.1.3(c); and
- (d) not contain any lead if used on a roof forming part of a potable water catchment area.

3.5.2.3 Selection of guttering

The size of guttering must—

- (a) be in accordance with [Table 3.5.2.2](#); and
- (b) be suitable to remove rainwater falling at the appropriate rainfall intensity listed in [Table 3.5.2.1](#) as follows—
 - (i) for eaves gutters — 20 year *average recurrence interval*; or
 - (ii) for internal box and valley gutters — 100 year *average recurrence interval*.

3.5.2.4 Installation of gutters

- (a) Gutters must be installed with a fall of not less than—
 - (i) 1:500 for eaves gutters, unless fixed to metal fascias; and
 - (ii) 1:100 for box gutters.
- (b) Eaves gutters must be supported by brackets securely fixed at stop ends and at not more than 1.2 m centres.
- (c) Valley gutters on a roof with a pitch—
 - (i) more than 12.5 degrees — must have width of not less than 400 mm and be wide enough to allow the roof covering to overhang not less than 150 mm each side of the gutter; or
 - (ii) not more than 12.5 degrees — must be designed as a box gutter.
- (d) Where high-fronted gutters are installed, provision must be made to avoid any overflow back into the roof or building structure by incorporating overflow measures or the like.

3.5.2.5 Downpipes — size and installation

Downpipes must—

- (a) not serve more than 12 m of gutter length for each downpipe; and

Explanatory information:

A maximum 12 m gutter length served by each downpipe is to ensure effective fall and adequate capacity to discharge all water anticipated during a heavy rain period.

- (b) be located as close as possible to valley gutters and, if the downpipe is more than 1.2 m from a valley, provision for overflow must be made to the gutter; and
- (c) be selected in accordance with the appropriate eaves gutter section as shown in [Table 3.5.2.2](#).

ROOF AND WALL CLADDING

Table 3.5.2.1 RAINFALL INTENSITIES

Locality	5 minute rainfall intensity (mm/h)		Locality	5 minute rainfall intensity (mm/h)	
	<i>Average recurrence interval, once in—</i>			<i>Average recurrence interval, once in—</i>	
	20 years	100 years		20 years	100 years
<u>ACT</u>			<u>SA</u>		
Canberra	137	194	Adelaide	123	186
			Mt Gambier	108	168
<u>NSW</u>			Murray Bridge	117	181
Albury	135	191	Port Augusta	124	189
Broken Hill	130	181	Port Pirie	125	201
Goulburn	145	197	Yorke town	118	197
Kiama	224	283			
Newcastle	181	233	<u>WA</u>		
Orange	152	214	Albany	142	217
Sydney	214	273	Broome	252	343
Tweed Heads	245	303	Bunbury	148	215
Wollongong	233	294	Derby	254	343
			Geraldton	132	173
<u>VIC</u>			Kalgoorlie	116	180
Ballarat	127	184	Perth	146	214
Benalla	133	187	Port Hedland	233	332
Geelong	118	172	Tom Price	164	222
Horsham	120	174			
Lakes Entrance	124	179	<u>TAS</u>		
Melbourne	127	186	Burnie	118	191
Mildura	125	174	Flinders Island	128	184
Stawell	127	185	Hobart	99	155
			Launceston	101	150
<u>QLD</u>			Queenstown	118	183
Brisbane	251	333	St. Marys	205	266
Bundaberg	241	318			
Cairns	282	368	<u>NT</u>		
Cape York	301	388	Alice Springs	139	204
Cloncurry	172	228	Darwin	285	366

ROOF AND WALL CLADDING

Table 3.5.2.1 RAINFALL INTENSITIES— continued

Locality	5 minute rainfall intensity (mm/h)		Locality	5 minute rainfall intensity (mm/h)	
	<i>Average recurrence interval, once in—</i>			<i>Average recurrence interval, once in—</i>	
	20 years	100 years		20 years	100 years
Innisfail	254	323	Katherine	230	304
Mackay	273	363			
Mt Isa	169	223			
Noosa	253	320			
Rockhampton	248	336			
Toowoomba	189	251			
Townsville	260	346			
Weipa	293	370			

Table 3.5.2.2 GUTTER AND DOWNPIPE SELECTION

Table a. Gutter sizes for various rainfall intensities and roof catchment areas per downpipe					
Design Rainfall Intensity (mm/h) (as per Table 3.5.2.1)	Roof Catchment Area per Downpipe — m ²				
	30	40	50	60	70
	Size of gutter required to drain roof catchment area into one (1) downpipe (A, B, C, D, E and F defined in Table b.)				
90	A or C	A or C	A or C	A or C	A or C
120	A or C	A or C	A or C	A or C	A or D
140	A or C	A or C	A or C	A or D	B or E
160	A or C	A or C	A or C	A or E	B or E
175	A or C	A or C	A or D	B or E	E
200	A or C	A or C	A or D	B or E	F
225	A or C	A or C	A or B	E	F
255	A or C	A or D	B or E	E	F
275	A or C	A or D	B or E	F	F
325	A or C	B or E	F	F	F
425	A or C	E	F	F	F

ROOF AND WALL CLADDING

Gutter Type (as per Table a.)	Gutter description	Minimum Cross Sectional Area mm ²
A	Medium rectangular gutter	6500
B	Large rectangular gutter	7900
C	115 mm D gutter	5200
D	125 mm D gutter	6300
E	150 mm D gutter	9000
F	Gutter must be designed in accordance with AS/NZS 3500.3 or Section 5 of AS/NZS 3500.5	

Downpipe Section	Gutter Sections — (as per Table b.)				
	A	B	C	D	E
75 mm dia.	Yes	Yes	Yes	Yes	No
100 mm × 50 mm	Yes	Yes	Yes	Yes	Yes
90 mm dia.	Yes	Yes	Yes	Yes	Yes
100 mm × 75 mm	Yes	Yes	Yes	Yes	Yes

Legend: Yes—downpipe is suitable for the eaves gutter selection; and
No—downpipe is not suitable for the eaves gutter selection.

Explanatory information:

Stormwater drainage systems specified in the *Housing Provisions* are not designed to remove all of the water during exceptionally heavy rain, especially in tropical areas. Accordingly, it is necessary to design and install the system so that when overflowing occurs any water is directed away in a manner which ensures it does not pond against, or enter into, the building.

This may be achieved by using overflow measures, oversized gutters and downpipes, locating the gutter so that it is below the top edge of the fascia or the installation of rainwater heads with overflows.

The installation of downpipes, especially near valley gutters, are designed to ensure rainwater from areas on the roof that have concentrated water flows perform adequately. If downpipe spacings are to be increased, allowance for overflow should be considered.

Consideration needs to be given to box gutters, valley gutters etc. located above the internal areas of a building and eaves gutters where overflowing rainwater can flow over the eaves lining and back into the building. In these situations if adequate overflow controls cannot be implemented there may be a need to increase the size and capacity of drainage components to remove all water anticipated during heavy rain periods.

There are many options available to designers using the requirements of the *Housing Provisions*. The designer will need to choose an overflow system that will cope with the expected rain intensity, i.e. in heavy downpours a slotted gutter may be inadequate.

PART 3.5.3 WALL CLADDING

Appropriate *Performance Requirements*:

Where an alternative wall cladding is proposed as an *Alternative Solution* to that described in **Part 3.5.3**, that proposal must comply with—

- (a) *Performance Requirement P2.1.1*; and
- (b) *Performance Requirement P2.2.2*; and
- (c) the relevant *Performance Requirements* determined in accordance with **1.0.10**.

A. Acceptable construction manual

3.5.3.0

Performance Requirements P2.1.1 and *P2.2.2* are satisfied for metal wall cladding if it is designed and constructed in accordance with AS 1562.1.

B. Acceptable construction practice

3.5.3.1 Application

Compliance with this acceptable construction practice satisfies *Performance Requirements P2.1.1* and *P2.2.2* for wall cladding provided—

- (a) the building is located in an area with a *design wind speed* of not more than N3; and

Explanatory information:

1. Information on *design wind speeds* for particular areas may be available from the *appropriate authority*.
2. A map indicating cyclonic regions of Australia is contained in **Part 3.10.1**.
3. For wall cladding in areas with a *design wind speed* of more than N3 refer to the appropriate design manual listed in **Part 3.11**.

- (b) wall cladding is installed in accordance with—
 - (i) **3.5.3.2** for timber weatherboard cladding; and
 - (ii) **3.5.3.3** for fibre-cement and hardboard wall cladding boards; and
 - (iii) **3.5.3.4** for fibre-cement, hardboard and plywood sheet wall cladding; and
- (c) fibre-cement sheet eaves are installed in accordance with **3.5.3.5**; and
- (d) openings in cladding are flashed in accordance with **3.5.3.6**.

ROOF AND WALL CLADDING

3.5.3.2 Timber weatherboard cladding

Timber cladding must be installed as follows:

- (a) Splayed timber weatherboards must be fixed in accordance with [Figure 3.5.3.1](#) and with a lap not less than—
 - (i) 30 mm for hardwood, cypress and treated pine; and
 - (ii) 20 mm for western red cedar; and
 - (iii) 25 mm for baltic pine.
- (b) Profiled timber boards must be—
 - (i) fixed with the overlap and groove closely fitted; and
 - (ii) with tongue and groove profile, fixed tongue edge up.
- (c) Spacing of fixings must be—
 - (i) one nail per board at each stud at not more than 650 mm centres measured along the board; and
 - (ii) nailed so that they do not penetrate the tip or thinner edge of the board beneath, i.e. for 30 mm lap, nail 35 mm from the butt (see [Figure 3.5.3.1](#)).
- (d) Nails used to fix timber cladding must comply with the following:
 - (i) Where nails are punched and filled prior to painting, with standard steel bullet-head nails.
 - (ii) Uncoated copper or steel nails must not be used for western red cedar (silicon bronze, monel metal, stainless steel or hot-dipped galvanised are suitable).
 - (iii) In all other cases, nails must be hot-dipped galvanised flat head or bullet head.
- (e) Acceptable nail sizes are—
 - (i) for hardwood and cypress frames — 50×2.8 mm plain shank; and
 - (ii) for softwood frames — 50×3.15 mm annular threaded.

3.5.3.3 Wall cladding boards

Wall cladding boards must—

- (a) for 7.5 mm (minimum) thick fibre-cement — comply with AS/NZS 2908.2 or ISO 8336; and
- (b) for 9.5 mm (minimum) thick hardboard — comply with AS/NZS 1859.4; and
- (c) be fixed in accordance with [Table 3.5.3.1](#) and [Figure 3.5.3.1](#).

Table 3.5.3.1 FIXING REQUIREMENTS FOR WALL CLADDING BOARDS

Material	Maximum stud spacing (mm)	Minimum lap (mm)	Stud fixings (mm)	
			Timber	Steel
Minimum 7.5 mm thick fibre-cement	600	25	40×2.8 G	(8–18)×35 S
Minimum 9.5 mm thick hardboard	600	20	50×2.8 GC	(8–18)×35 S

ROOF AND WALL CLADDING

Table 3.5.3.1 *FIXING REQUIREMENTS FOR WALL CLADDING BOARDS— continued*

Legend:

- G = Galvanised fibre-cement nail
- GC = Galvanised clout or flathead nail
- S = Self embedding head screw

ROOF AND WALL CLADDING

Figure 3.5.3.1

FIXING OF WALL CLADDING

Diagram a. Timber Cladding

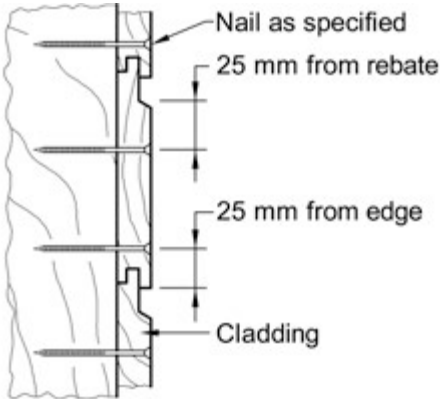

(a) (i) Shiplap weather board

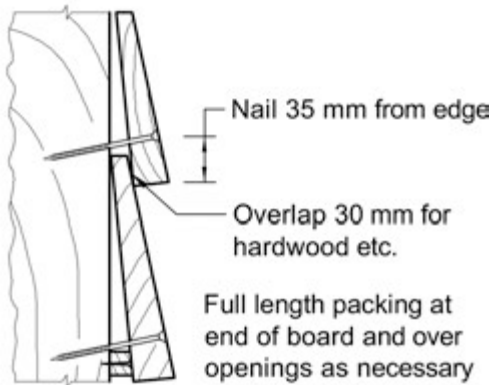

(a) (ii) Splayed weather board

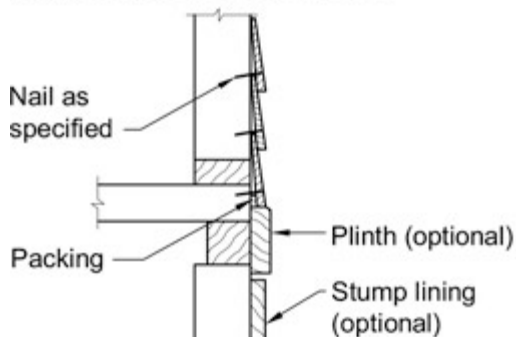

(a) (iii) Section at lower part of weatherboard building

Diagram b. Wall Cladding Boards

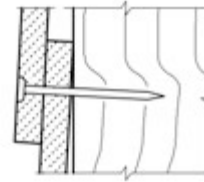

(b) (i) Timber stud nailing

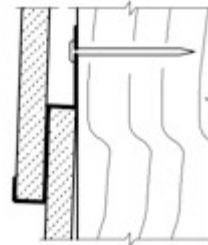

(b) (ii) Timber stud clip

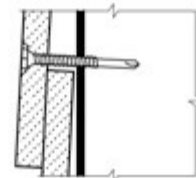

(b) (iii) Steel stud screwing

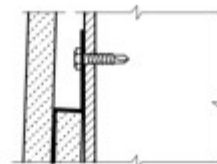

(b) (iv) Steel stud clip

3.5.3.4 Sheet wall cladding

(a) Fibre-cement sheet wall cladding must—

ROOF AND WALL CLADDING

- (i) comply with AS/NZS 2908.2 or ISO 8336; and
- (ii) be fixed in accordance with [Table 3.5.3.2](#) and [Figure 3.5.3.2](#); and
- (iii) where also acting as structural bracing, be installed using the lesser of the stud and fixing spacings for both applications.

Table 3.5.3.2 STUD AND FIXING SPACINGS FOR 6 mm FIBRE-CEMENT SHEET WALL CLADDING

<i>Design wind speed</i>	Maximum stud spacing		Maximum nail spacing (2.8 mm fibre-cement nails)			
	Within 1200 mm of the external corners of the building	Elsewhere	Within 1200 mm of the external corners of the building		Elsewhere	
			Body	Edges	Body	Edges
N1	600	600	300	200	300	200
N2	600	600	200	200	300	200
N3	450	600	200	200	200	200

Figure 3.5.3.2

SHEET FIXING DETAIL

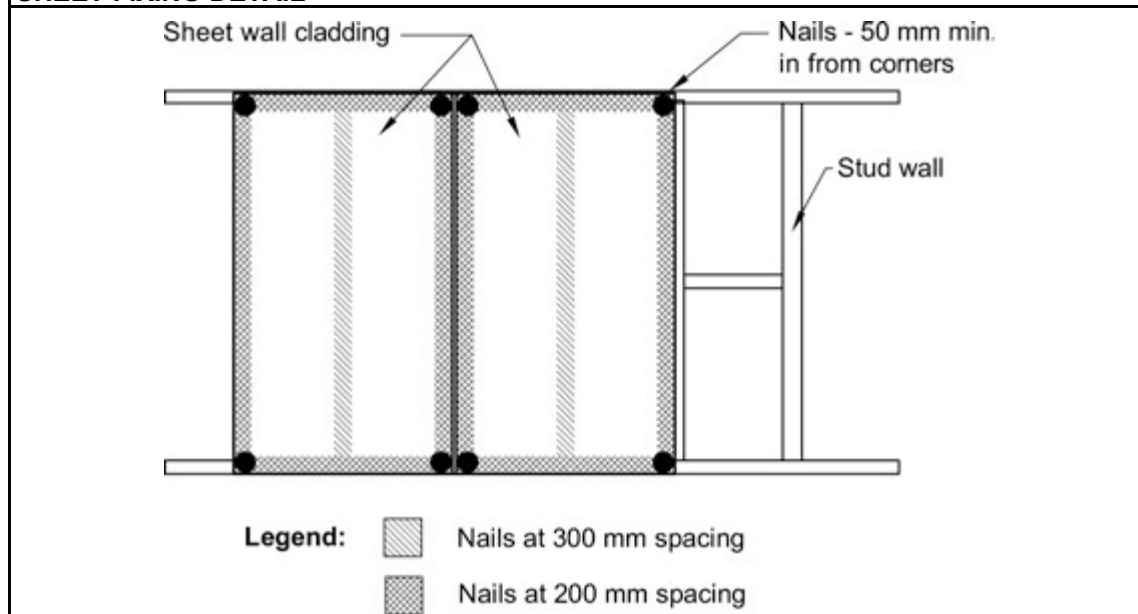

- (b) Hardboard sheet wall cladding must—
 - (i) comply with AS/NZS 1859.4; and
 - (ii) be fixed in accordance with [Table 3.5.3.3](#); and
 - (iii) where also acting as structural bracing, be installed using the lesser of the stud and fixing spacings for both applications.

ROOF AND WALL CLADDING

Table 3.5.3.3 STUD AND FIXING SPACINGS FOR 9.5 mm HARDBOARD SHEET WALL CLADDING

<i>Design wind speed</i>	Maximum stud spacing		Maximum nail spacing (2.8 mm galvanised clouts or flat head nails)			
	Within 1200 mm of the external corners of the building	Elsewhere	Within 1200 mm of the external corners of the building		Elsewhere	
			Body	Edges	Body	Edges
N1	600	600	300	150	300	150
N2	600	600	300	150	300	150
N3	600	600	300	150	300	150

Note: Fixings must be positioned a minimum of 12 mm from the edge of the sheet.

- (c) Structural plywood wall cladding must—
- (i) comply with AS/NZS 2269; and
 - (ii) be fixed in accordance with the following:
 - (A) Where structural plywood acts as combined cladding and structural bracing it must comply with [Table 3.5.3.4](#).
 - (B) Sheets not more than 9 mm thick must be fixed using 2.8 or 3.5×30 mm long galvanised clouts or flat head nails spaced at—
 - (aa) 150 mm centres along sheet edges; and
 - (bb) 300 mm for intermediate fixings.
 - (C) Sheets more than 9 mm thick must be fixed with 2.8 or 3.5 mm galvanised clouts or flat head nails with a length calculated using the following formula:
Minimum nail length (L) = plywood thickness + (10 x diameter of nail)
 - (D) The fixings must be located not less than 9 mm from the edge of the sheet.

Explanatory information:

The above formula is applied as follows:

For 12 mm plywood and 2.8 mm diameter nail.

$L = 12 + 28 \text{ mm}$; therefore the nail length must be 40 mm.

Table 3.5.3.4 MINIMUM STRUCTURAL PLYWOOD THICKNESS FOR COMBINED BRACING AND EXTERNAL CLADDING (mm)

Plywood stress grade	Stud spacing (mm)					
	Plywood face grain parallel to studs			Plywood face grain at right angles to studs		
	450	600	900	450	600	900
F8	9	12	16	7	9	12

ROOF AND WALL CLADDING

Table 3.5.3.4 MINIMUM STRUCTURAL PLYWOOD THICKNESS FOR COMBINED BRACING AND EXTERNAL CLADDING (mm)—
continued

Plywood stress grade	Stud spacing (mm)					
	Plywood face grain parallel to studs			Plywood face grain at right angles to studs		
	450	600	900	450	600	900
F11	8	12	16	6	8	12
F14	7	12	16	6	7	12

3.5.3.5 Eaves and soffit linings

External fibre-cement sheets and linings used as eaves and soffit linings must—

- (a) comply with AS/NZS 2908.2 or ISO 8336; and
- (b) be fixed in accordance with [Table 3.5.3.5](#) and [Figure 3.5.3.3](#) using—
 - (i) 2.8×30 mm fibre-cement nails; or
 - (ii) No. 8 wafer head screws (for 4.5 mm and 6 mm sheets only); or
 - (iii) No. 8 self embedding head screws (for 6 mm sheets only).

Table 3.5.3.5 TRIMMER AND FASTENER SPACINGS FOR 4.5 AND 6 mm FIBRE-CEMENT EAVES AND SOFFIT LININGS

Maximum eaves width	<i>Design wind speed</i>	Maximum trimmer spacings (mm)		Maximum fastener spacings (mm)	
		Within 1200 mm of the external corners of the building	Elsewhere	Within 1200 mm of the external corners of the building	Elsewhere
600	N1	600	900	200	300
	N2	600	800	200	300
	N3	500	700	200	300
1200	N1	600	750	200	300
	N2	600	700	200	300
	N3	500	650	200	300

ROOF AND WALL CLADDING

Figure 3.5.3.3

EAVES TRIMMER DETAIL

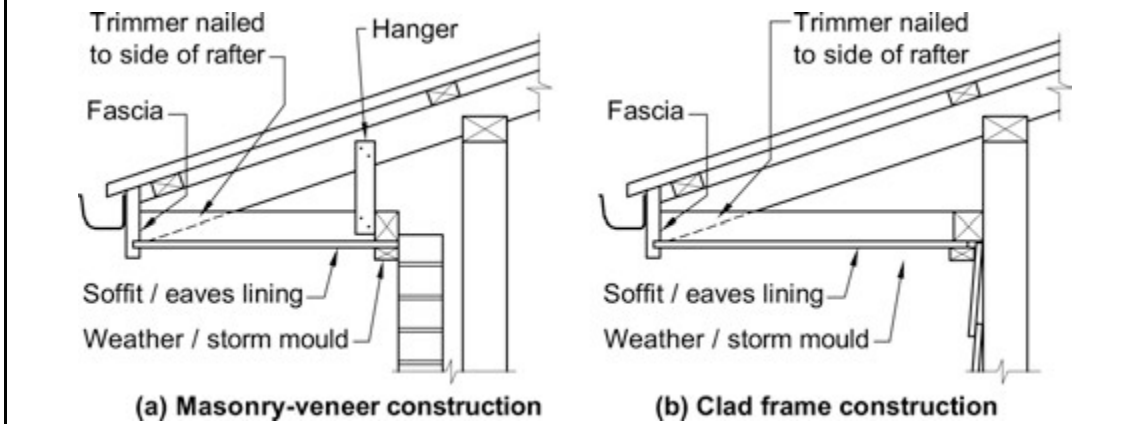

3.5.3.6 Flashings to wall openings

Openings in *external wall* cladding exposed to the weather must be flashed as follows:

- (a) All openings must be adequately flashed using materials that comply with AS/NZS 2904.
- (b) *Flashings* must be securely fixed at least 25 mm under the cladding and extend over the ends and edges of the framing of the opening (see [Figure 3.5.3.4](#)).

ROOF AND WALL CLADDING

Figure 3.5.3.4

TYPICAL WINDOW FLASHING DETAIL

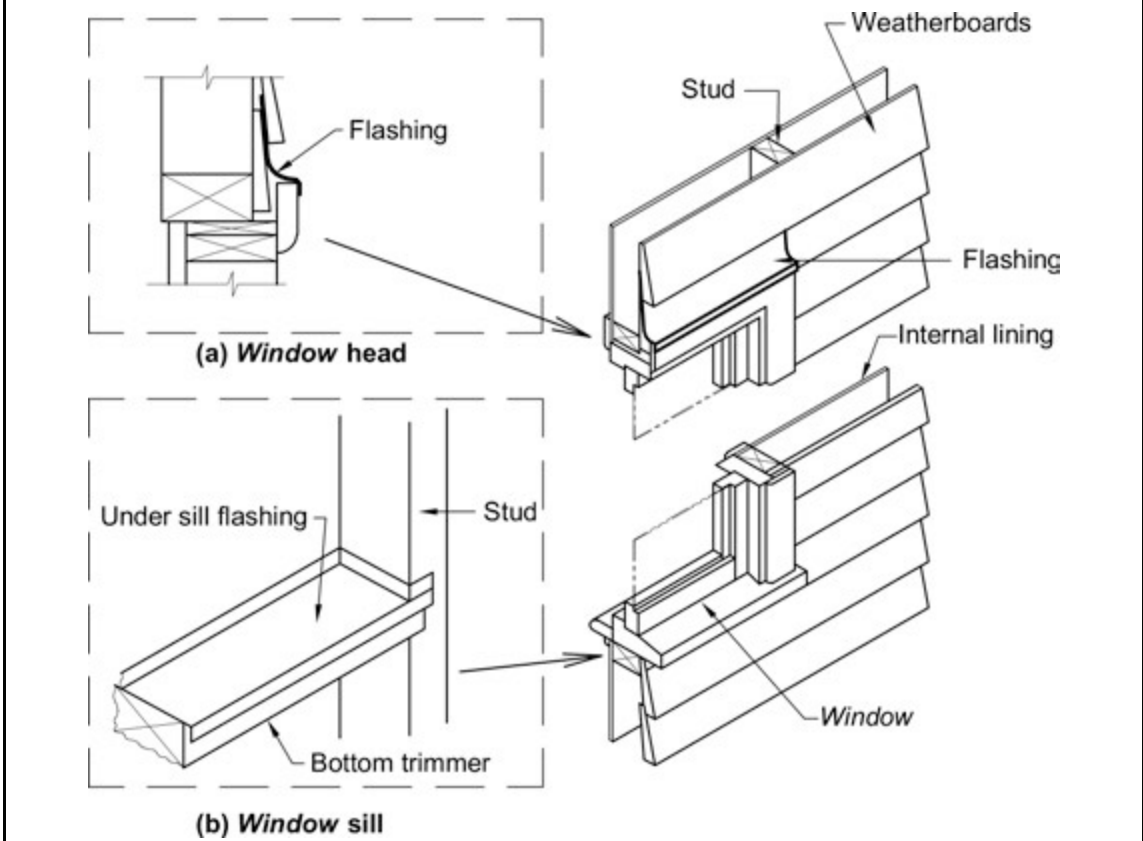

PART **3.6**

GLAZING

3.6 Glazing

PART 3.6 CONTENTS

PART 3.6 GLAZING

3.6

Glazing

3.6 Definitions

3.6.0 Acceptable construction manuals

3.6.1 Application

3.6.2 Glazing sizes and installation

3.6.3 Fully framed glazing installed in perimeter of buildings

3.6.4 Human impact safety requirements

3.6.4.1 Doors

3.6.4.2 Door side panels

3.6.4.3 Full height framed glazed panels

3.6.4.4 Glazed panels, other than doors or side panels, on the perimeter of rooms

3.6.4.5 Bathroom, ensuite and spa room glazing

3.6.4.6 Visibility of glazing

PART 3.6 GLAZING

Appropriate *Performance Requirements*:

Where an alternative glazing system is proposed as an *Alternative Solution* to that described in **Part 3.6**, that proposal must comply with—

- (a) *Performance Requirement P2.1.1*; and
- (b) *Performance Requirement P2.2.2*; and
- (c) the relevant *Performance Requirements* determined in accordance with **1.0.10**.

Definitions

3.6

The following definitions are used in this Part:

Perimeter of building means the external envelope of a building.

Unobstructed opening means a glazed area that a person could mistake for an open doorway or clearway and walk into the glazed panel.

A. Acceptable construction manuals

3.6.0

- (a) *Performance Requirements P2.1.1* and *P2.2.2* are satisfied for glazing and *windows* if designed and constructed in accordance with AS 2047 for the following glazed assemblies in an *external wall*:
 - (i) *Windows* excluding those listed in (b).
 - (ii) Sliding and swinging glazed doors with a frame, including french and bi-fold doors with a frame.
 - (iii) Adjustable louvres.
 - (iv) *Window* walls with one piece framing.
- (b) *Performance Requirement P2.1.1* is satisfied for glazing if designed and constructed in accordance with AS 1288 for all glazed assemblies not covered by (a) and the following glazed assemblies:
 - (i) All glazed assemblies not in an *external wall*.
 - (ii) Revolving doors.
 - (iii) Fixed louvres.

GLAZING

- (iv) Skylights, roof lights and *windows* in other than the vertical plane.
- (v) Sliding and swinging doors without a frame.
- (vi) *Windows* constructed on site and architectural one-off *windows*, which are not design tested in accordance with AS 2047.
- (vii) Second-hand *windows*, re-used *windows* and recycled *windows*.
- (viii) Heritage *windows*.
- (ix) Glazing used in balustrades and sloping overhead glazing.

Explanatory information:

1. The reference to heritage *windows* in **3.6.0(b)(viii)** is intended to apply to *windows* in heritage buildings. The method of determining a heritage building is normally covered by the relevant State or Territory authority.
2. When satisfying *Performance Requirement P2.2.2* "Weatherproofing", **Part 3.6** only contains the acceptable construction manual AS 2047 for *windows*. If AS 1288 is used as an acceptable construction manual for glazing in an *external wall*, it is still necessary to satisfy **P2.2.2**.

B. Acceptable construction practice

3.6.1 Application

Compliance with this acceptable construction practice satisfies *Performance Requirement P2.1.1* for glazing, provided—

- (a) the building is located in an area with a *design wind speed* of not more than N3; and

Explanatory information:

1. Information on *design wind speeds* for particular areas may be available from the *appropriate authority*.
 2. For glazing in *high wind areas* refer to **Part 3.10.1**.
- (b) glass is of a type recognised by AS 1288; and
 - (c) safety glazing is legibly marked in accordance with AS 1288; and
 - (d) glazing used in barriers complies with AS 1288; and
 - (e) safety glazing is made visible in accordance with **3.6.4.6**; and
 - (f) the glazing is not for the following assemblies in an *external wall*:
 - (i) *Windows* excluding those listed in **(g)**.
 - (ii) Sliding and swinging doors with a frame, including french and bi-fold doors with a frame.
 - (iii) Adjustable louvres.
 - (iv) *Window* walls with one piece framing; and
 - (g) the glazing is for all assemblies not covered by **(f)** and the following glazed assemblies:

GLAZING

- (i) All glazed assemblies not in an *external wall*.
- (ii) Revolving doors.
- (iii) Fixed louvres.
- (iv) Skylights, roof lights and *windows* in other than the vertical plane.
- (v) Sliding and swinging doors without a frame.
- (vi) *Windows* constructed on site and architectural one-off *windows*, which are not design tested in accordance with AS 2047.
- (vii) Second-hand *windows*, re-used *windows* and recycled *windows*.
- (viii) Heritage *windows*.

Explanatory information:

This acceptable construction practice applies to the selection of glass only and does not include the installation of *windows* or framed glazed doors. This is due to *window* systems relying on the design and testing of structural system members to withstand wind loads (eg; mullions, transoms, and meeting rails and stiles) and the perimeter frame design, sealants and gaskets to resist water penetration.

3.6.2 Glazing sizes and installation

Glazing used in buildings must comply with the following:

- (a) Glazing used in the *perimeter of buildings* and supported on all sides must comply with the appropriate provisions listed in **3.6.3**.
- (b) Glazing used in areas where the potential for human impact could occur must comply with the appropriate provisions listed in **3.6.4**.
- (c) For 3 mm monolithic annealed glass, the maximum area must not be more than 0.85 m².
- (d) For 3 mm annealed glass used in Insulated Glass Units (IGU), the maximum area must not be more than 1.36 m².

Explanatory information:

An Insulated Glass Unit consists of two or more panes of glass spaced apart and factory sealed with dry air or special gases in the cavity. The term is often abbreviated to IGU.

- (e) All exposed edges must have sharp edges removed.

Explanatory information:

The selection of glass thickness relies not just on limit state wind loads but on a number of geometric criteria that include the influence of aspect ratio and slenderness factors. These factors are taken into account in **Tables 3.6.1** to **3.6.3**.

3.6.3 Fully framed glazing installed in perimeter of buildings

Fully framed (supported on all sides) ordinary annealed glass (including annealed patterned glass) installed in the *perimeter of buildings* must comply with—

- (a) if the building is located in an area with a wind class not exceeding N1 – **Table 3.6.1**; or

GLAZING

- (b) if the building is located in an area with a wind class not exceeding N2 – [Table 3.6.2](#); or
- (c) if the building is located in an area with a wind class not exceeding N3 – [Table 3.6.3](#).

Explanatory information:

1. For other types of perimeter glazing including toughened, wired, laminated and unframed glazing refer to AS 1288.
2. For ordinary annealed patterned glass thickness measurement refer to AS 1288.

Table 3.6.1 GLASS THICKNESS FOR WIND CLASS NOT EXCEEDING N1: ORDINARY ANNEALED GLASS

		EDGE 1 (mm)										
		300	450	600	750	900	1050	1200	1350	1500	1650	
EDGE 2 (mm)	300	3	3	3	3	3	3	3	3	3	3	3
	450	3	3	3	3	3	3	3	3	3	3	3
	600	3	3	3	3	3	3	3	3	3	4	4
	750	3	3	3	3	3	3	3	4	4	4	4
	900	3	3	3	3	3	3	4	4	4	4	4
	1050	3	3	3	3	4	4	4	4	4	4	4
	1200	3	3	3	4	4	4	4	4	4	4	4
	1350	3	3	3	4	4	4	4	4	4	4	4
	1500	3	3	4	4	4	4	4	4	4	4	4
	1650	3	3	4	4	4	4	4	4	4	4	4
	1800	3	3	4	4	4	4	4	4	4	4	4
	1950	3	4	4	4	4	4	4	4	4	4	4
	2100	3	4	4	4	4	4	4	4	4	4	4
	2250	3	4	4	4	4	4	4	4	4	4	4
	2400	3	4	4	4	4	4	4	4	4	4	4
2550	3	4	4	4	4	4	4	4	4	4	4	
2700	3	4	4	4	4	4	4	4	4	4	4	

GLAZING

Table 3.6.2 GLASS THICKNESS FOR WIND CLASS NOT EXCEEDING N2: ORDINARY ANNEALED GLASS

		EDGE 1 (mm)										
		300	450	600	750	900	1050	1200	1350	1500	1650	
EDGE 2 (mm)	300	3	3	3	3	3	3	3	3	3	3	3
	450	3	3	3	3	3	3	3	3	3	3	3
	600	3	3	3	3	3	3	3	3	3	4	4
	750	3	3	3	3	3	3	3	4	4	4	4
	900	3	3	3	3	3	3	4	4	4	4	4
	1050	3	3	3	3	4	4	4	4	4	4	4
	1200	3	3	3	4	4	4	4	4	4	4	4
	1350	3	3	3	4	4	4	4	4	4	4	4
	1500	3	3	4	4	4	4	4	4	4	4	4
	1650	3	3	4	4	4	4	4	4	4	4	4
	1800	3	3	4	4	4	4	4	4	4	4	4
	1950	3	4	4	4	4	4	4	4	4	4	4
	2100	3	4	4	4	4	4	4	4	4	4	5
	2250	3	4	4	4	4	4	4	4	4	4	5
	2400	3	4	4	4	4	4	4	4	4	4	5
2550	3	4	4	4	4	4	4	4	4	5	5	
2700	3	4	4	4	4	4	4	4	4	5	5	

GLAZING

Table 3.6.3 GLASS THICKNESS FOR WIND CLASS NOT EXCEEDING N3: ORDINARY ANNEALED GLASS

		EDGE 1 (mm)										
		300	450	600	750	900	1050	1200	1350	1500	1650	
EDGE 2 (mm)	300	3	3	3	3	3	3	3	3	3	3	3
	450	3	3	3	3	3	3	3	3	3	3	3
	600	3	3	3	3	3	3	3	3	3	4	4
	750	3	3	3	3	3	3	3	4	4	4	4
	900	3	3	3	3	3	3	4	4	4	4	4
	1050	3	3	3	3	3	4	4	4	4	4	4
	1200	3	3	3	4	4	4	4	4	4	4	4
	1350	3	3	3	4	4	4	4	4	4	4	5
	1500	3	3	4	4	4	4	4	4	4	5	5
	1650	3	3	4	4	4	4	4	4	5	5	5
	1800	3	3	4	4	4	4	4	4	5	5	5
	1950	3	4	4	4	4	4	4	5	5	5	5
	2100	3	4	4	4	4	4	4	5	5	5	6
	2250	3	4	4	4	4	4	4	5	5	5	6
	2400	3	4	4	4	4	4	4	5	5	6	6
2550	3	4	4	4	4	5	5	5	5	6	6	
2700	3	4	4	4	4	5	5	5	5	6	6	

3.6.4 Human impact safety requirements

The thickness and type of glazing installed in areas of a building that have a high potential for human impact (an area of a building frequented by the occupants during everyday activities in which a person could fall into or against the glazed panel) must comply as follows:

- Doors — in accordance with [3.6.4.1](#).
- Door side panels — in accordance with [3.6.4.2](#).
- Full height glass panels — in accordance with [3.6.4.3](#).
- Glazed panels, other than doors or side panels, on the perimeter of rooms — in accordance with [3.6.4.4](#).
- Bathrooms, ensuite and spa room glazing — in accordance with [3.6.4.5](#).
- Visibility of glazing — in accordance with [3.6.4.6](#).

3.6.4.1 Doors

Glass in doors must be Grade A safety glazing material in accordance with [Table 3.6.5](#) and [Figure 3.6.1](#), except that—

GLAZING

- (a) unframed doors, other than those incorporated in shower screens or bath enclosures, must be glazed with toughened safety glass with a minimum nominal thickness of 10 mm or laminated toughened safety glass with a minimum total thickness of 10 mm; and
- (b) individual pieces of ordinary annealed glass incorporated in leadlights may be used, to a maximum area of 0.05 m² with a minimum nominal thickness of 3 mm; and

Explanatory information:

Larger areas of ordinary annealed glass in leadlights are not permitted regardless of glass thickness.

- (c) for annealed and annealed decorated glass panels in doors—
 - (i) for 3 mm and 4 mm annealed glass, the maximum area must not be more than 0.1 m² with a maximum panel width of 125 mm; and
 - (ii) for 5 mm and 6 mm annealed glass, the maximum area must not be more than 0.26 m² with a maximum panel width of 300 mm; and
- (d) for annealed glass in fully framed panels with a thickness of 10 mm or more, with or without bevelled edges, the maximum area must not be more than 0.5 m²; and
- (e) doors in bathrooms, ensuites and spa rooms must be glazed in accordance with [3.6.4.5](#).

3.6.4.2 Door side panels

- (a) All framed glass (except leadlight panels) in side panels with their nearest vertical sight line less than 300 mm from the nearest edge of the doorway opening must be Grade A safety glazing material in accordance with [Table 3.6.5](#) and [Figure 3.6.1](#), except that—
 - (i) where the lowest visible sight line is 1.2 m or more above the highest abutting finished floor level, ordinary annealed glass in accordance with [Table 3.6.4](#) may be used; or
 - (ii) where the lowest visible sight line is less than 1.2 m above the highest abutting finished floor level, ordinary annealed glass in accordance with [Table 3.6.4](#), with an area of not more than 0.5 m², may be used; or
 - (iii) where the side panel consists of glass louvres with exposed edges or where the louvres are installed less than 500 mm above the highest abutting finished floor level—
 - (A) for blade widths not more than 230 mm with blade lengths not more than 1 m, Grade A toughened safety glazing not less than 5 mm thick must be used; and
 - (B) for blade widths more than 230 mm, Grade A toughened safety glazing not less than 10 mm thick must be used.
- (b) Framed glass panels with the nearest vertical sight line not less than 300 mm from the nearest edge of the door opening are not considered to be side panels for the purposes of (a).

Table 3.6.4 MAXIMUM AREAS OF ORDINARY ANNEALED GLASS IN SIDE PANELS

Minimum nominal thickness (mm)	Maximum area of pane (m ²)
3	0.8
4	1.4

GLAZING

Table 3.6.4 MAXIMUM AREAS OF ORDINARY ANNEALED GLASS IN SIDE PANELS — continued

Minimum nominal thickness (mm)	Maximum area of pane (m ²)
5	2.2
6	3.3

3.6.4.3 Full height framed glazed panels

- (a) A glazed panel located in a building so that it is capable of being mistaken for an *unobstructed opening* must be glazed with—
- Grade A safety glazing material in accordance with **Table 3.6.5**; or
 - ordinary annealed glass complying with **Table 3.6.5** provided the glazed area is not more than 0.9 m².
- (b) Glazed panels are not considered an *unobstructed opening* where any of the following apply:
- The clear opening width is not more than 500 mm.
 - The lowest sight line of the opening is not less than 500 mm above the highest abutting finished floor level.
 - The glass is made apparent by means of transoms, colonial bars, other components of the glazing system, permanent motifs or other decorative treatment on or etched into the glass, of sufficient magnitude to be readily apparent, or the glass is opaquely coloured or patterned to indicate its presence.
 - A chair rail or handrail not less than 40 mm thick, or the like, is provided at a height of 865 mm above the adjoining ground level.
 - The difference in floor level on either side of the panel is greater than 500 mm.

Figure 3.6.1

IDENTIFICATION OF GLAZING REQUIREMENTS FOR DOORS AND SIDE PANELS

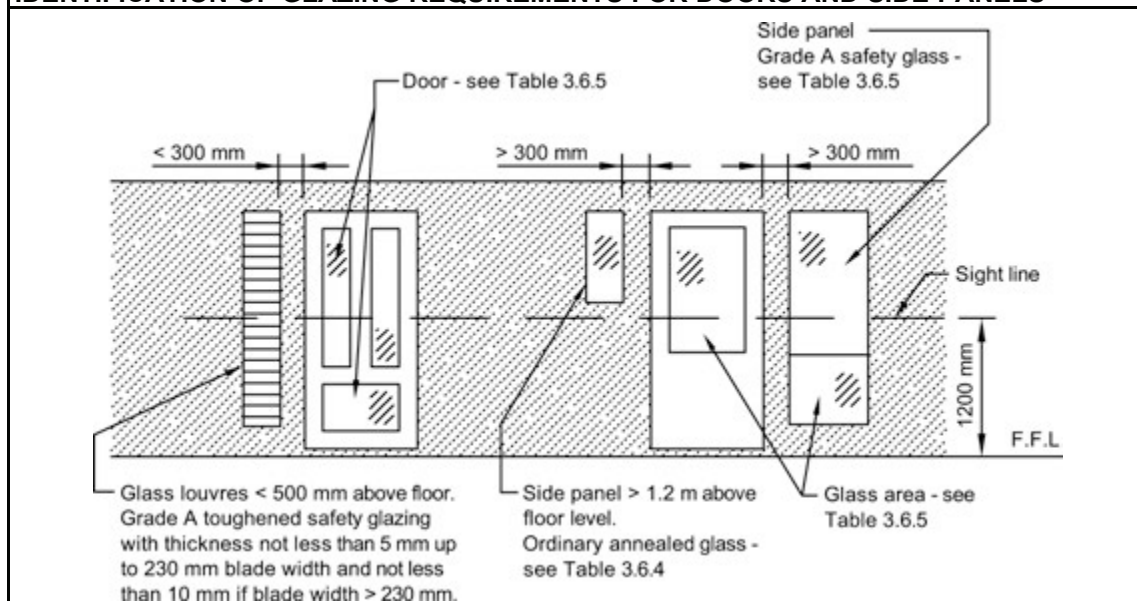

GLAZING

Table 3.6.5 MAXIMUM AREAS OF GLAZING MATERIAL FOR FRAMED GLASS DOORS, FRAMED GLASS SIDE PANELS, AND OTHER FRAMED GLAZED PANELS

Type of glass	Minimum nominal thickness (mm)	Maximum area of pane (m ²)
Patterned or clear ordinary annealed glass	5	0.3
	6	0.9
Grade A Toughened and toughened laminated safety glass	3	1
	4	2
	5	3
	6	4
Grade A laminated safety glass	5.38	2.2
	6.38	3
	8.38	5

3.6.4.4 Glazed panels, other than doors or side panels, on the perimeter of rooms

All framed glazing where the lowest sight line of the glazing panel is less than 500 mm from the highest abutting finished floor level (see [Figure 3.6.2](#)) must be—

- Grade A safety glazing material in accordance with [Table 3.6.5](#); or
- ordinary annealed glass not less than 5 mm nominal thickness provided that the area of the glazing panel is not more than 1.2 m².

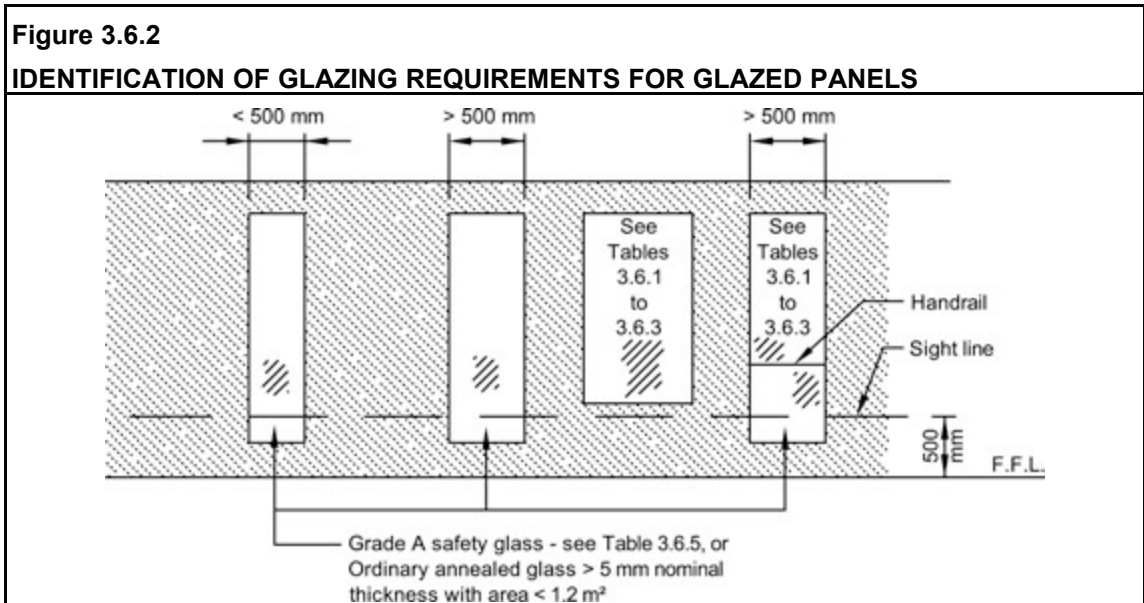

GLAZING

3.6.4.5 Bathroom, ensuite and spa room glazing

- (a) All glazing in bathrooms, ensuites, spa rooms or the like, including shower doors, shower screens, bath enclosures, and associated *windows*, where the lowest sight line is less than 2.0 m above the highest abutting finished level of the floor, bottom of the bath, or shower base, must—
- (i) for framed panels, be glazed with—
 - (A) Grade A safety glazing material in accordance with **Table 3.6.5**; or
 - (B) Grade B safety glazing material in accordance with **Table 3.6.6** (see also **Figure 3.6.3**); or
 - (ii) for panels or doors with any edge exposed, be toughened safety glass in accordance with **Table 3.6.5** with a minimum nominal thickness of 6 mm.
- (b) *Windows* referred to in (a), may incorporate annealed glass panels of not less than 4 mm thickness, provided that they are not more than 0.1 m² in area.
- (c) Ordinary annealed glass, including mirror, may be used provided a fixed vanity or bench with a height of not less than 760 mm, depth of not less than 300 mm and extending the full width of the glass or mirror is located in front of the glass or mirror.

Explanatory information:

Care should be taken when using showers fitted with safety wired glass, safety organic-coated glass, and laminated safety glass products that are liable to damage from thermal shock. Thermal shock occurs from hot water from the shower hitting the shower screen during cold weather.

Table 3.6.6 MAXIMUM AREAS OF GRADE B SAFETY GLAZING MATERIALS FOR SHOWER DOORS, SHOWER SCREENS AND BATH ENCLOSURES

Type of glass	Standard nominal thickness (mm)	Maximum area of pane (m ²)	Area (Fig. 3.6.3)
Safety wired glass	Greater than or equal to 6	2.5	A, B, C
Safety organic coated glass	3	1	A, B, C, D
	4	1.5	
	5	2	
	Greater than or equal to 6	3	

GLAZING

Figure 3.6.3

IDENTIFICATION OF GLAZING REQUIREMENTS FOR BATHROOMS, ENSUITES AND SPA ROOMS

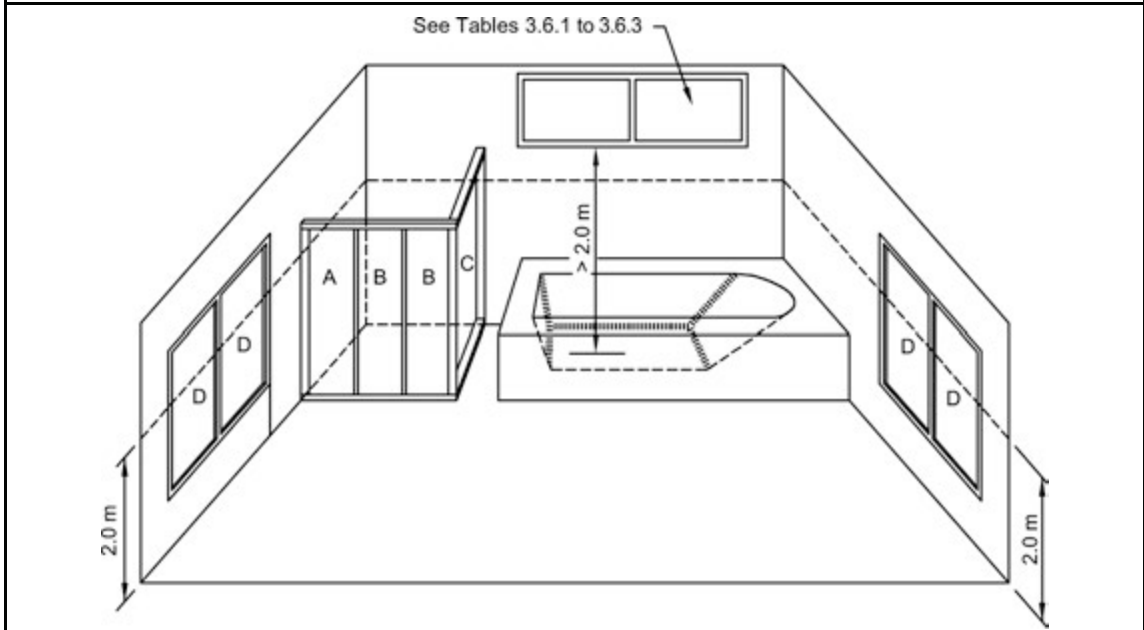

3.6.4.6 Visibility of glazing

- (a) If the presence of glazing in a door, side panel or panel capable of being mistaken for a doorway or opening is not made apparent in accordance with 3.6.4.3(b)(iii), the glass must be marked to make it readily visible in accordance with (b).
- (b) Marking must be in the form of an opaque band not less than 20 mm in height located so that—
 - (i) the upper edge is not less than 700 mm above the floor; and
 - (ii) the lower edge is not more than 1.2 m above the floor.

Explanatory information:

1. Making the glass visible by marking is not a substitute for the use of safety glazing in accordance with this Part.
 2. A broken line or patterns may be an acceptable form of marking provided it meets the criteria set out in 3.6.4.6(b).
- (c) A band or marking is not *required* where any of the following applies:
- (i) The height of the glazing is not more than 1 m in any part.
 - (ii) The width of the glazing panel is not more than 500 mm in any part.
 - (iii) There is no glazing within 700 mm of the floor.
 - (iv) The glazing is provided with not less than one fixed glazing bar which must—
 - (A) be firmly attached to the styles to locate and protect each face of the glass; and

GLAZING

- (B) be located with its upper edge not less than 500 mm and its bottom edge not more than 1 m above the floor; and
- (C) have a face width not less than 40 mm.

PART **3.7**

FIRE SAFETY

- 3.7.1 Fire Separation**
- 3.7.2 Smoke Alarms**
- 3.7.3 Heating Appliances**
- 3.7.4 Bushfire Areas**
- 3.7.5 Alpine Areas**

PART 3.7 CONTENTS

PART 3.7 FIRE SAFETY

3.7.1 Fire separation

- 3.7.1.1 Application
- 3.7.1.2 General concession — non-combustible materials
- 3.7.1.3 External walls of Class 1 buildings
- 3.7.1.4 Measurement of distances
- 3.7.1.5 Construction of external walls
- 3.7.1.6 Class 10a buildings
- 3.7.1.7 Allowable encroachments
- 3.7.1.8 Separating walls
- 3.7.1.9 Fire hazard properties
- 3.7.1.10 Roof lights

3.7.2 Smoke alarms

- 3.7.2.1 Application
- 3.7.2.2 Requirements for smoke alarms
- 3.7.2.3 Location — Class 1a buildings
- 3.7.2.4 Location — Class 1b buildings
- 3.7.2.5 Lighting to assist evacuation — Class 1b buildings

3.7.3 Heating appliances

- 3.7.3.0 Acceptable construction manuals
- 3.7.3.1 Application
- 3.7.3.2 Open fireplace construction
- 3.7.3.3 Chimney construction
- 3.7.3.4 Installation of insert fireplaces and flues
- 3.7.3.5 Installation of free standing heating appliances

3.7.4 Bushfire areas

- 3.7.4.0 Acceptable construction manual

3.7.5 Alpine areas

- 3.7.5.1 Application
- 3.7.5.2 External doorways
- 3.7.5.3 External ramps
- 3.7.5.4 Discharge of external doorways providing a means of egress
- 3.7.5.5 External trafficable structures

PART 3.7.1 FIRE SEPARATION

Appropriate *Performance Requirements*:

Where an alternative fire separation design is proposed as an *Alternative Solution* to that described in **Part 3.7.1**, that proposal must comply with—

- (a) *Performance Requirement P2.3.1*; and
- (b) the relevant *Performance Requirements* determined in accordance with **1.0.10**.

Acceptable construction practice

3.7.1.1 Application

Compliance with this acceptable construction practice satisfies *Performance Requirement P2.3.1* for fire separation.

3.7.1.2 General concession — non-combustible materials

The following materials, though *combustible* or containing *combustible* fibres, may be used wherever a *non-combustible* material is *required* in the *Housing Provisions*—

- (a) plasterboard; and
- (b) perforated gypsum lath with a normal paper finish; and
- (c) fibrous-plaster sheet; and
- (d) fibre-reinforced cement sheeting; and
- (e) pre-finished metal sheeting having a *combustible* surface finish not exceeding 1 mm thick and where the *Spread-of-Flame Index* of the product is not more than 0; and
- (f) bonded laminated materials where—
 - (i) each laminate is *non-combustible*; and
 - (ii) each adhesive layer is not more than 1 mm thick; and
 - (iii) the total thickness of adhesive layers is not more than 2 mm; and
 - (iv) the *Spread-of-Flame Index* and the *Smoke-Developed Index* of the laminated material as a whole does not exceed 0 and 3 respectively.

3.7.1.3 External walls of Class 1 buildings

An *external wall* of a Class 1 building, and any openings in that wall, must comply with **3.7.1.5** if the wall is less than—

- (a) 900 mm from an allotment boundary other than the boundary adjoining a road alignment or other public space; or

FIRE SAFETY

- (b) 1.8 m from another building on the same allotment other than an appurtenant Class 10 building or a detached part of the same Class 1 building.

STATE AND TERRITORY VARIATIONS

In South Australia delete 3.7.1.3(b) and insert SA 3.7.1.3(b) and (c) as follows:

- (b) 1.8 m from another building on the same allotment other than an appurtenant Class 10 building or a detached part of the same Class 1 building; or
- (c) 3 m from a *brush fence*.

3.7.1.4 Measurement of distances

- (a) The distance from any point on an *external wall* of a building to an allotment boundary or another building is the distance to that point measured along a line at right angles from the allotment boundary or *external wall* of the other building which intersects that point without being obstructed by a wall complying with 3.7.1.5.
- (b) Where a wall within a specified distance is *required* to be constructed in a certain manner, only that part of the wall (including any openings) within the specified distance need be constructed in that manner.

(see [Figure 3.7.1.1](#) and [3.7.1.2a](#))

- (c) Where the distance measured is between buildings of different heights, the distance must be taken from the *external wall* with the highest elevation measured at right angles to a point that intersects a vertical projection above the adjacent wall (see [Figure 3.7.1.2b](#)).

STATE AND TERRITORY VARIATIONS

In South Australia after 3.7.1.4(c) insert SA 3.7.1.4(d) as follows:

- (d) The distance from any point on an *external wall* of a building to a *brush fence* is measured in any direction from the *external wall*.

FIRE SAFETY

Figure 3.7.1.1

WALLS AT RIGHT ANGLES TO THE BOUNDARY

Notes:

1. No protection *required* for the wall at right angles or more to the boundary.
2. For protection of encroachments refer [3.7.1.7](#).

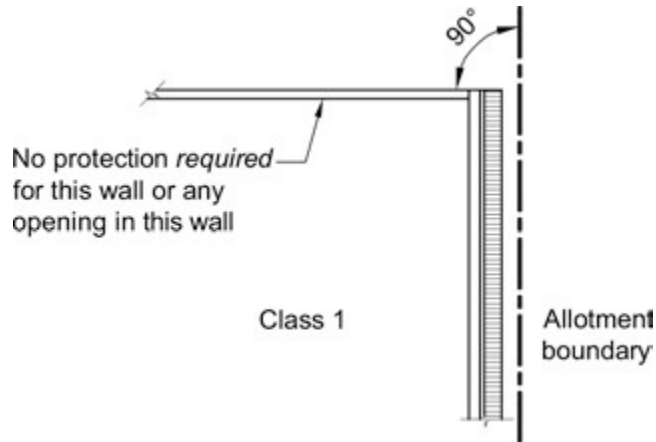
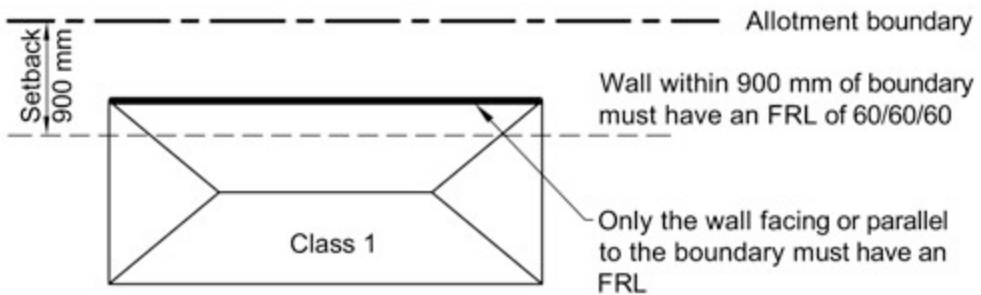

Figure 3.7.1.2a

MEASUREMENT OF DISTANCES (Plan view)

Diagram a. Full wall protection



FIRE SAFETY

Figure 3.7.1.2a

MEASUREMENT OF DISTANCES (Plan view)

Diagram b. Part walls protection

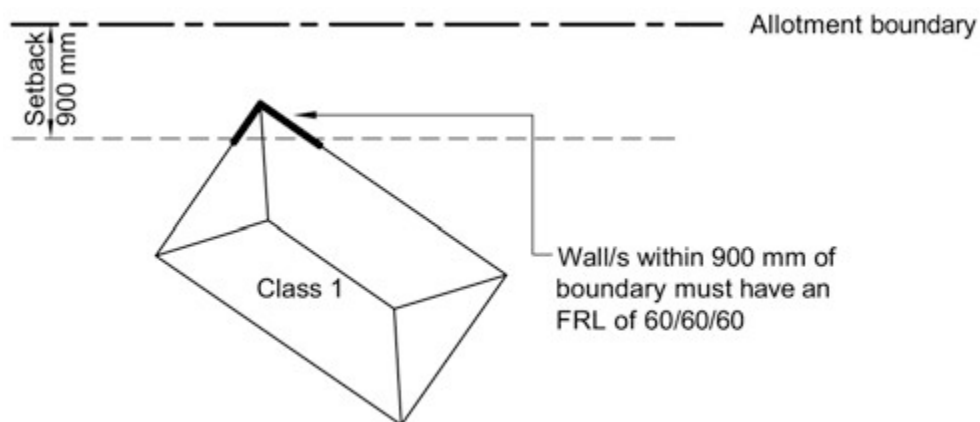

Note: Setback distance is measured at right angles to the boundary.

Figure 3.7.1.2b

MEASUREMENT OF DISTANCE — BUILDINGS OF DIFFERENT HEIGHTS

Class 1 buildings on same allotment

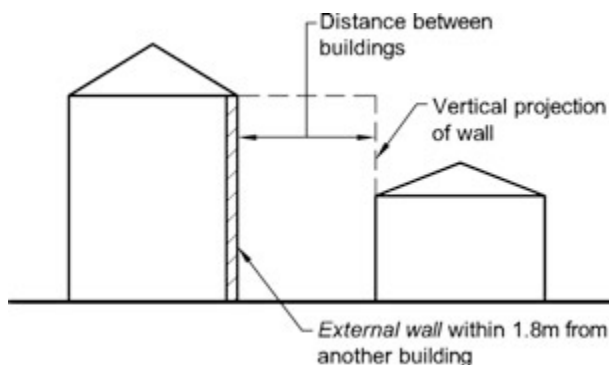

3.7.1.5 Construction of external walls

- (a) *External walls* (including gables) *required* to be *fire-resisting* (referred to in 3.7.1.3 or 3.7.1.6) must extend to the underside of a *non-combustible* roof covering or *non-combustible* eaves lining (See Figure 3.7.1.3) and must—
- (i) have an FRL of not less than 60/60/60 when tested from the outside; or
 - (ii) be of masonry-veneer construction in which the external masonry veneer is not less than 90 mm thick; or
 - (iii) be of masonry construction not less than 90 mm thick.

FIRE SAFETY

Explanatory information:

The intent of the typical construction details shown in **Figure 3.7.1.3** is to ensure that combustible materials (external or internal) are not directly exposed to fire at the junction of the wall and non-combustible roof, eaves lining, guttering and the like. Other forms of construction may also be acceptable provided that they achieve this intent.

See **Figure 3.7.1.10** and **3.8.6.3** for internal *separating wall* construction under one common roof.

- (b) Openings in *external walls required* to be *fire-resisting* (referred to in **3.7.1.3** or **3.7.1.6**) must be protected by—
 - (i) non-openable fire *windows* or other construction with an FRL of not less than *-/60/-*; or
 - (ii) *self-closing* solid core doors not less than 35 mm thick.
- (c) Sub-floor vents, roof vents, weepholes, control joints, construction joints and penetrations for pipes, conduits and the like need not comply with **(b)**.
- (d) Concessions for non-*habitable room windows*.

Despite the requirements in **(b)**, in a non-*habitable room*, a *window* that faces the boundary of an adjoining allotment may be not less than 600 mm from that boundary or, where the *window* faces another building on the same allotment, not less than 1200 mm from that building provided that—

- (i) in a bathroom, laundry or toilet, the opening has an area of not more than 1.2 m²; or
- (ii) in a room other than referred to in **(i)**, the opening has an area of not more than 0.54 m² and—
 - (A) the *window* is steel-framed, there are no opening sashes and it is glazed in wired glass; or
 - (B) the opening is enclosed with translucent hollow glass blocks.

FIRE SAFETY

Figure 3.7.1.3

TYPICAL CONSTRUCTION OF EXTERNAL WALLS

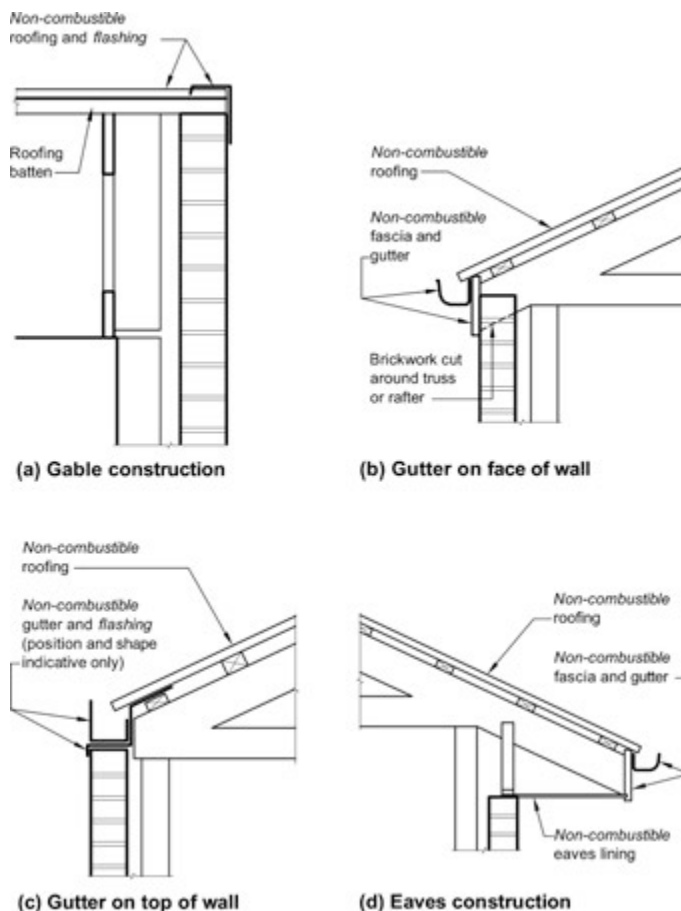

Notes:

1. The *external wall* is deemed to extend to the underside of *non-combustible* roof covering, or *non-combustible* eaves lining, when constructed as shown.
2. Where sarking is installed it must be located so that ponding of water is avoided between the fascia and the first roofing batten.
3. The location of flashing and framing is indicative only.

3.7.1.6 Class 10a buildings

- (a) Where a Class 10a building is located between a Class 1 building and the allotment boundary, other than the boundary adjoining a road alignment or other public space, the Class 1 building must be protected by one of the following methods shown in [Figure 3.7.1.4](#).
- (b) Where a Class 10a building is located between a Class 1 building to which it is appurtenant and another building on the same allotment, the Class 1 building must be protected by one of the methods shown in [Figure 3.7.1.5](#).

FIRE SAFETY

- (c) Where two or more Class 10a buildings on the same allotment are appurtenant to different Class 1 buildings, the Class 10a buildings must be separated in accordance with one of the methods shown in [Figure 3.7.1.6](#).

Figure 3.7.1.4

PROTECTION OF CLASS 1 BUILDINGS — CLASS 10a BETWEEN CLASS 1 AND THE ALLOTMENT BOUNDARY

Legend:



Wall with an FRL of
60/60/60



Allotment boundary

a. 900 mm from allotment boundary

The Class 10a building is not less than 900 mm from the allotment boundary, other than the boundary adjoining a road alignment or other public space.

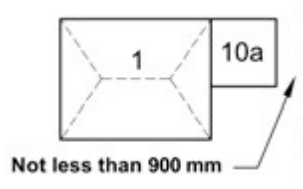
b. *External wall* to Class 10a building with FRL

An *external wall* of the Class 10a building which is less than 900 mm from an allotment boundary, other than the boundary adjoining a road alignment or other public space, complies with [3.7.1.5](#).

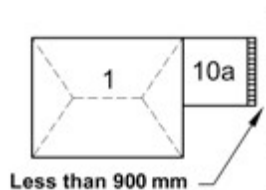
c. *External wall* to Class 10a building with FRL

An *external wall* of the Class 10a building which is less than 900 mm from the Class 1 building complies with [3.7.1.5](#).

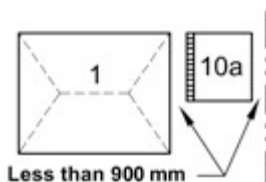

d. 900 mm separation between buildings

The Class 1 building is not less than 900 mm from the Class 10a building.

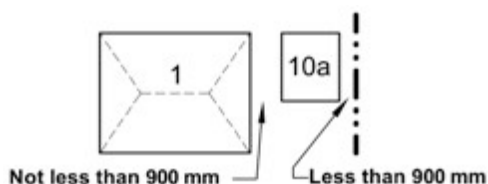

FIRE SAFETY

Figure 3.7.1.4

PROTECTION OF CLASS 1 BUILDINGS — CLASS 10a BETWEEN CLASS 1 AND THE ALLOTMENT BOUNDARY

Legend:

Wall with an FRL of
60/60/60

Allotment boundary

e. Class 1 building with FRL to *external wall*

An *external wall* of the Class 1 building which is less than 900 mm from the Class 10a building complies with 3.7.1.5.

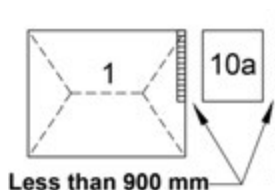

Figure 3.7.1.5

PROTECTION OF CLASS 1 BUILDINGS — CLASS 10a BETWEEN CLASS 1 AND OTHER BUILDINGS ON ALLOTMENT

Legend:

Wall with a FRL of
60/60/60Other Class of
building on
allotment

a. 1.8 m from other building on allotment

The Class 10a building is not less than 1.8 m from the other building.

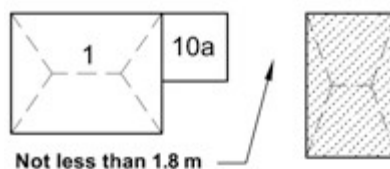
b. *External wall* to Class 10a building with FRL

An *external wall* of the Class 10a building which is less than 1.8 m from the other building complies with 3.7.1.5.

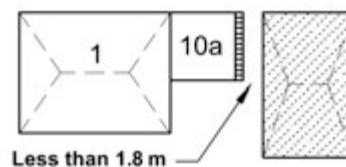
c. *External wall* to Class 10a building with FRL

An *external wall* of the Class 10a building which is less than 1.8 m from the Class 1 building complies with 3.7.1.5.

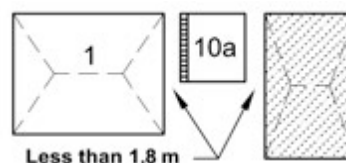

FIRE SAFETY

Figure 3.7.1.5

PROTECTION OF CLASS 1 BUILDINGS — CLASS 10a BETWEEN CLASS 1 AND OTHER BUILDINGS ON ALLOTMENT

Legend:



Wall with a FRL of 60/60/60



Other Class of building on allotment

d. 1.8 m separation between Class 1 and 10a

The Class 1 building is not less than 1.8 m from the Class 10a building.

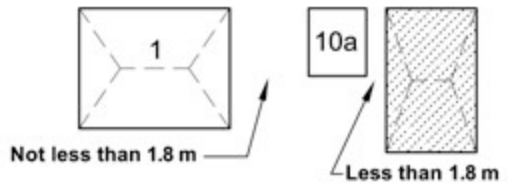

e. Class 1 building with FRL to external wall

An external wall of the Class 1 building which is less than 1.8 m from the Class 10a building complies with 3.7.1.5.

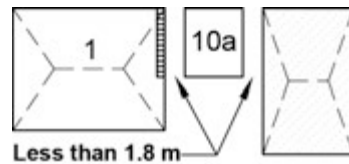

Figure 3.7.1.6

PROTECTION OF CLASS 1 BUILDINGS — SEPARATION OF CLASS 10a BUILDINGS ON AN ALLOTMENT

Legend:



Wall with a FRL of 60/60/60

a. 1.8 m between Class 10a buildings

Each 10a must be separated from each other by a distance of not less than 1.8 m.

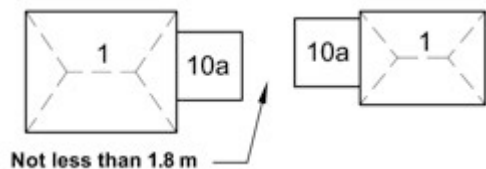

b. External wall to Class 10a building with FRL

Each 10a must be separated from each other by external walls complying with 3.7.1.5.

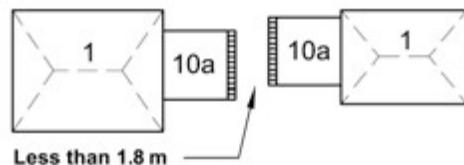

FIRE SAFETY

Figure 3.7.1.6

PROTECTION OF CLASS 1 BUILDINGS — SEPARATION OF CLASS 10a BUILDINGS ON AN ALLOTMENT

Legend:



Wall with a FRL of 60/60/60

c. 900 mm separation between Class 10a and Class 1 buildings

Each 10a must be separated from each Class 1 building by a distance of not less than 900 mm.

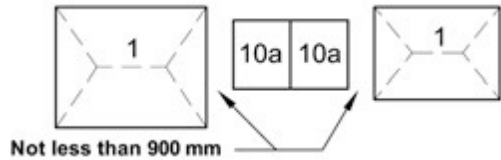
d. *External wall* to Class 10a buildings with FRL

Each 10a must be separated from each Class 1 building by *external walls* complying with 3.7.1.5.

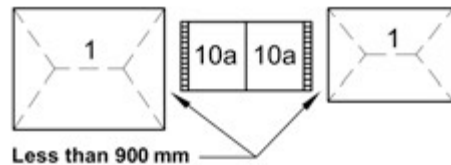

e. Class 10a buildings with FRL to separating wall

Each 10a must be separated by a wall complying with 3.7.1.8.

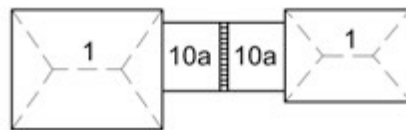

- (d) A carport is exempt from (a), (b) and (c) if—
- (i) it has two or more sides open and not less than one third of its perimeter open and, for the purposes of this clause, a side is considered to be open if the roof covering adjacent to that side is not less than 500 mm from another building or allotment boundary; and
 - (ii) it has a polycarbonate or *non-combustible* roof covering and any ceiling lining and wall cladding, including gables, is also *non-combustible* (see Figure 3.7.1.7); and

FIRE SAFETY

Figure 3.7.1.7

IDENTIFYING AN OPEN CARPORT

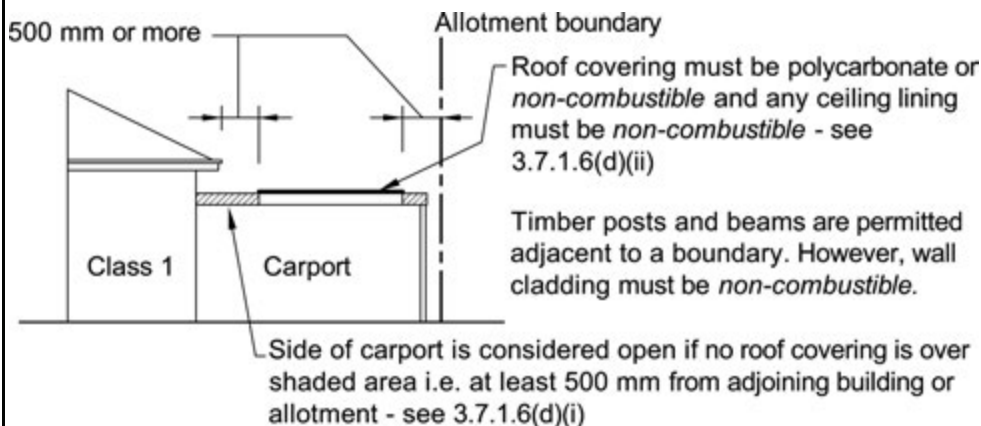

(a) Example A

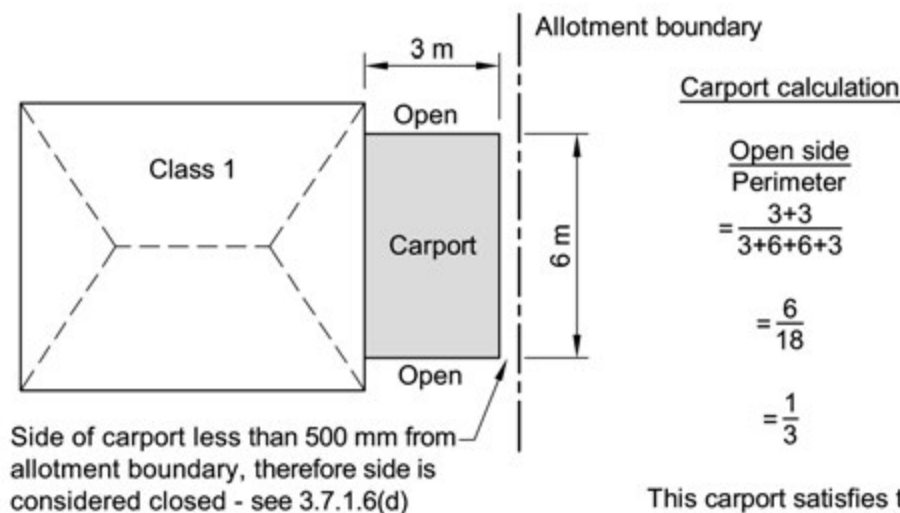

(b) Example B

- (iii) it does not provide direct vertical support to any part of the Class 1 building; and
- (iv) in the case where it has a common roof structure with the Class 1 building and the carport does not have a ceiling (see [Figure 3.7.1.8](#)), the opening between the top of the wall of the Class 1 building and the underside of the roof covering is infilled with—
 - (A) a *non-combustible* material; or
 - (B) construction clad with *non-combustible* material on the carport side.

FIRE SAFETY

STATE AND TERRITORY VARIATIONS

In South Australia delete 3.7.1.6(d) and insert SA 3.7.1.6(d) as follows:

- (d) A carport or verandah is exempt from (a), (b) and (c) if—
- (i) it has—
 - (A) two or more sides open and not less than one third of its perimeter open and, for the purpose of this clause, a side is considered to be open if the roof covering adjacent to that side is not less than 500 mm from another building or allotment boundary; or
 - (B) any part of the *external wall* of the Class 1 building located less than 2 m from the allotment boundary or less than 4 m from another Class 1 building on the same allotment is *fire-resisting* to the underside of a *non-combustible* roof covering or to the underside of a *non-combustible* ceiling lining (see **Figures SA 3.7.1.7a**, **SA 3.7.1.7b** and **SA 3.7.1.7c**); and
 - (ii) it has polycarbonate or *non-combustible* roof covering and any ceiling lining and wall cladding, including gables, is also *non-combustible* (see **Figure 3.7.1.7**); and
 - (iii) it does not provide direct vertical support to any part of the Class 1 building; and
 - (iv) in the case where it has a common roof structure with the Class 1 building and the carport or verandah does not have a ceiling (see **Figure 3.7.1.8**), the opening between the top of the wall of the Class 1 building and the underside of the roof covering is infilled with—
 - (A) a *non-combustible* material; or
 - (B) construction clad with *non-combustible* material on the carport or verandah side; and
 - (v) in the case where two carports or verandahs have a common roof structure with two different Class 1 buildings and the carports or verandahs have a ceiling, the roof space or ceiling space between the top of the ceiling and the underside of the roof covering is infilled as follows—
 - (A) vertically between the two Class 1 buildings and between the two appurtenant carports or verandahs in accordance with **SA 3.7.1.6(d)(iv)** (see **Figure SA 3.7.1.7d**); or
 - (B) vertically between the two Class 1 buildings and between the two appurtenant carports or verandahs in accordance with **SA 3.7.1.6(d)(iv)**, except that the construction must be clad with *non-combustible* materials on both sides and must not be crossed by timber or other *combustible* building elements except for roof battens with dimensions of 75 × 50 mm or less, roof *sarking-type material* or a timber gutter board not less than 20 mm thick.

FIRE SAFETY

Figure SA 3.7.1.7a

Fire-resisting requirements for carports or verandahs without a ceiling

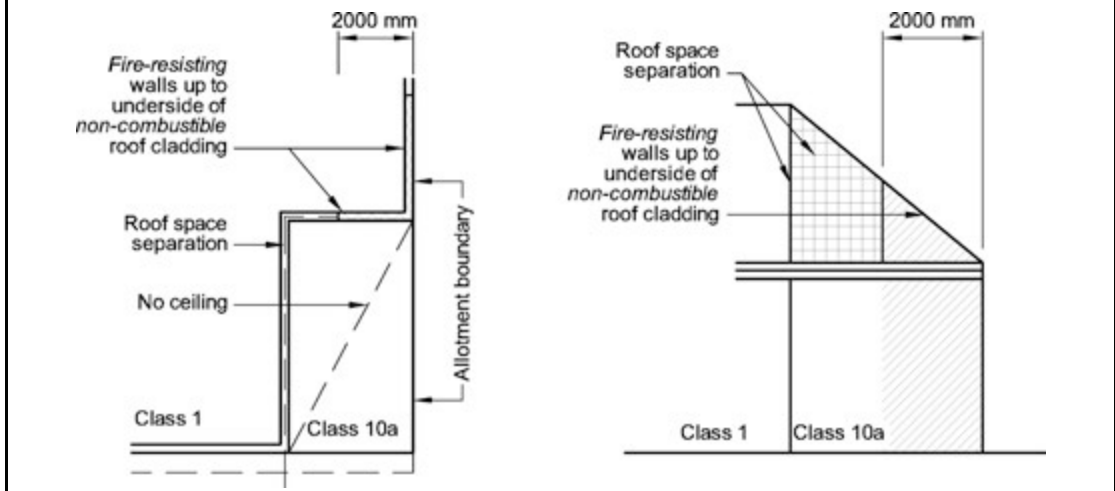
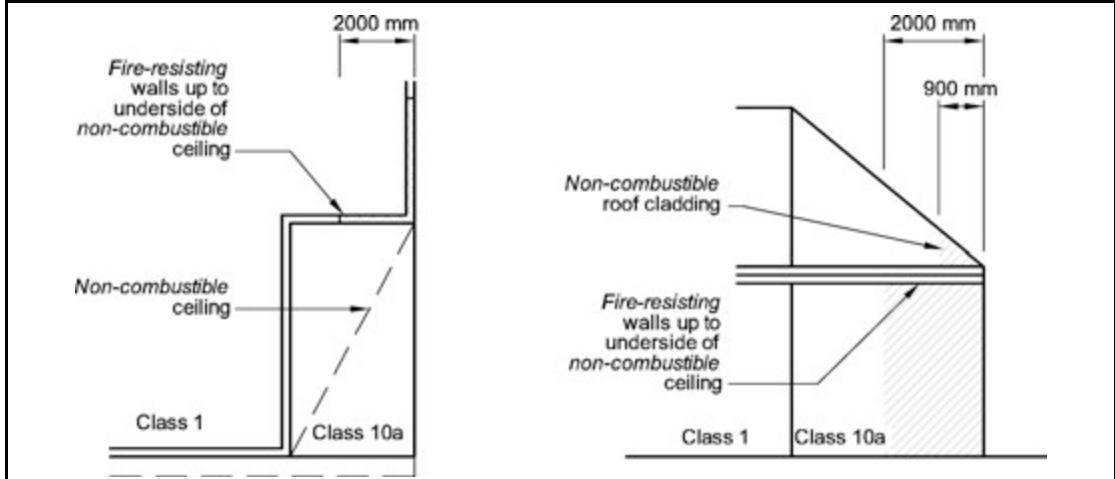

Figure SA 3.7.1.7b

Fire-resisting requirements for carports or verandahs with a non-combustible ceiling



FIRE SAFETY

Figure SA 3.7.1.7c

Fire-resisting requirements for external walls in carports and verandahs that share a common roof space

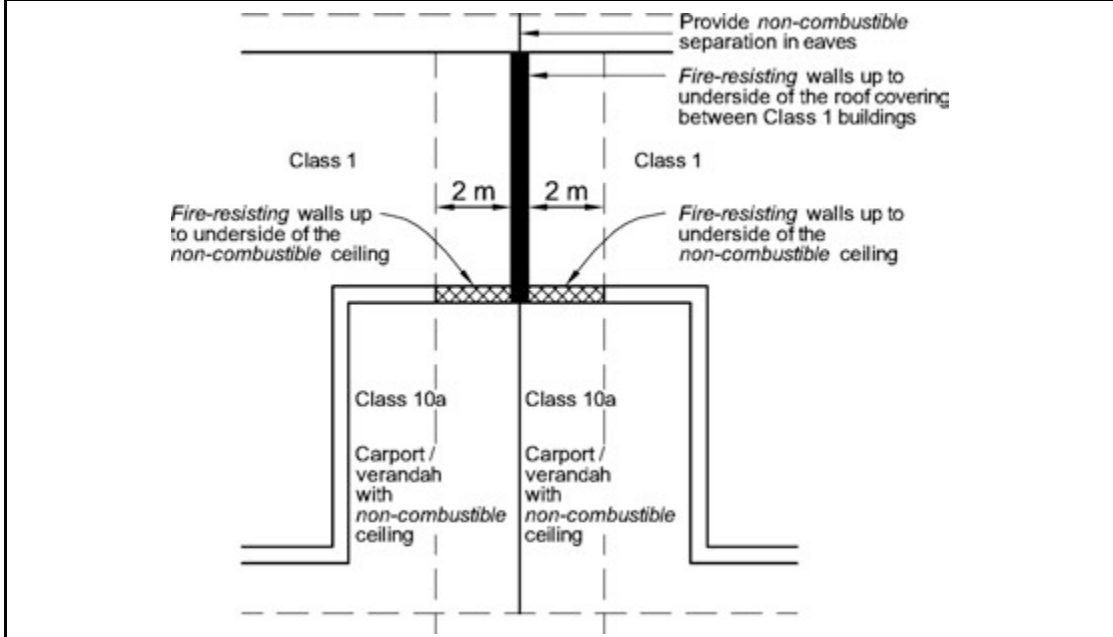
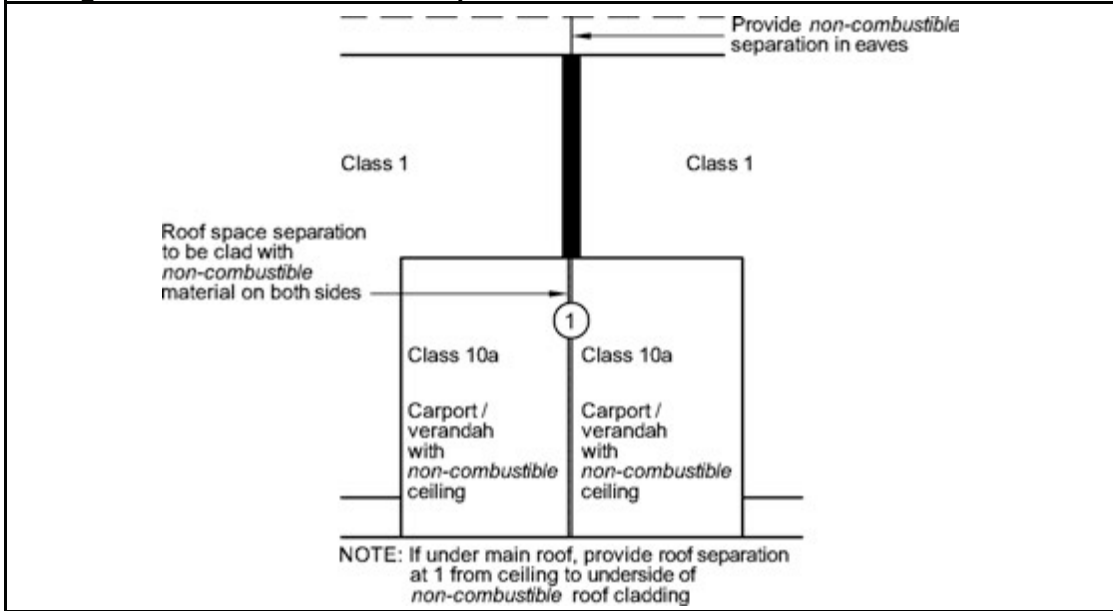

Figure SA 3.7.1.7d

Fire-resisting requirements for roof space openings in carports and verandahs with a ceiling that share a common roof space



FIRE SAFETY

Figure 3.7.1.8

REQUIREMENTS FOR NON-COMBUSTIBLE INFILL PANELS TO CARPORT

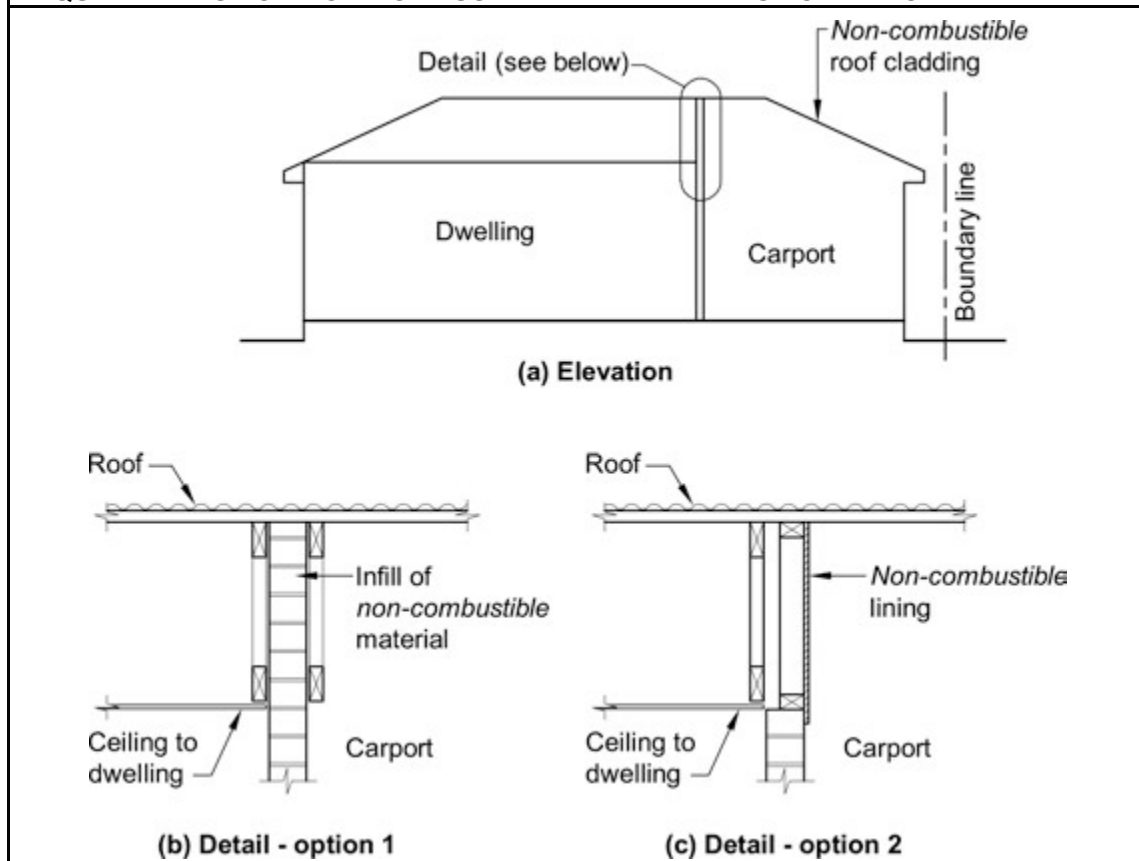

- (e) Class 10a buildings must not significantly increase the risk of spread of fire between Class 2 to 9 buildings.

STATE AND TERRITORY VARIATIONS

In South Australia after 3.7.1.6(e) insert SA 3.7.1.6(f) and (g) as follows:

- (f) A carport or verandah may have timber posts and timber roof support beams regardless of the distance from the boundary.
- (g) A Class 10b *brush fence* must not be constructed within 3 m of a Class 1 building unless any part of the building within 3 m of the *brush fence* complies with the *fire-resisting* requirements of 3.7.1.3, 3.7.1.4, 3.7.1.5 and 3.7.1.7.

3.7.1.7 Allowable encroachments

- (a) An encroachment is any construction between the *external wall* of the building and the allotment boundary other than a boundary adjoining a road or other public space, or the *external walls* of two buildings on the same allotment and relates to any *external wall* of—
- a Class 10a building *required* to comply with 3.7.1.5; or
 - a Class 1 building.

FIRE SAFETY

- (b) The encroachments allowed within 900 mm of an allotment boundary or within 1.8 m of another building on the same allotment are—
- (i) fascias, gutters and downpipes; and
 - (ii) eaves with *non-combustible* roof cladding and *non-combustible* lining; and
 - (iii) flues, chimneys, pipes, domestic fuel tanks, cooling or heating appliances or other services; and
 - (iv) light fittings, electricity or gas meters, aerials or antennas; and
 - (v) pergolas, sun blinds or water tanks; and
 - (vi) unroofed terraces, landings, steps and ramps, not more than 1 m in height.
- (c) Encroachments listed in (b)(i), if *combustible*, (b)(ii) and (b)(iii) must not be built within 450 mm of an allotment boundary nor be built within 900 mm of the *external wall* or associated encroachments of another building on the same allotment (see **Figure 3.7.1.9**).

Explanatory information:

A deck is not considered an unroofed terrace and is therefore not permitted as an allowable encroachment under **3.7.1.7(b)** whether *combustible* or not.

The term pergola is a reference to an unroofed structure.

STATE AND TERRITORY VARIATIONS

In South Australia delete 3.7.1.7 and insert SA 3.7.1.7 and Figure SA 3.7.1.9a as follows:

- (a) An encroachment is any construction between the *external wall* of the building and the allotment boundary other than a boundary adjoining a road or other public space, between the *external wall* of the building and a *brush fence*, or between the *external walls* of two buildings on the same allotment and relates to any *external wall* of—
- (i) a Class 10a building *required* to comply with **3.7.1.5**; or
 - (ii) a Class 1 building.
- (b) The encroachments allowed within 900 mm of an allotment boundary, within 1.8 m of another building on the same allotment or within 3 m of a *brush fence* are—
- (i) fascias, gutters, downpipes; and
 - (ii) eaves with *non-combustible* roof cladding and *non-combustible* lining; and
 - (iii) flues, chimneys, pipes, domestic fuel tanks, cooling or heating appliances or other services; and
 - (iv) light fittings, electricity or gas meters, aerials or antennas; and
 - (v) pergolas, sun blinds or water tanks; and

FIRE SAFETY

- (vi) unroofed terraces, landings, steps and ramps, not more than 1 m in height.
- (c) Except as permitted by (d) encroachments listed in (b)(i), if *combustible*, (b)(ii) and (b)(iii) must not be built within 450 mm of an allotment boundary nor be built within 900 mm of the *external wall* or associated encroachments of another building on the same allotment (see Figure 3.7.1.9).
- (d) Eaves with *non-combustible* roof cladding and *non-combustible* soffit or lining may encroach within 450 mm of the allotment boundary where the *external walls* of a building are located not less than 900 mm from the allotment boundary and the walls are positioned at an angle of not less than 20 degrees and not more than 70 degrees to the allotment boundary or other building and the eaves only encroach at the corner of the roof (see SA Figure 3.7.1.9a).
- (e) Fascias listed in (b)(i), if combustible, must not be built within 3 m of a *brush fence*.

Figure SA 3.7.1.9a

Concession for encroachment of eaves

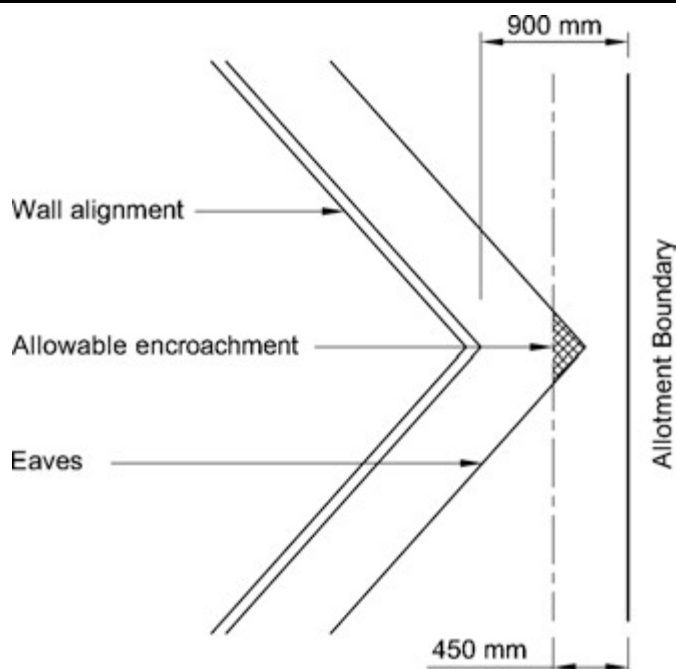

FIRE SAFETY

Figure 3.7.1.9

ALLOWABLE ENCROACHMENTS FOR NON-COMBUSTIBLE CONSTRUCTION

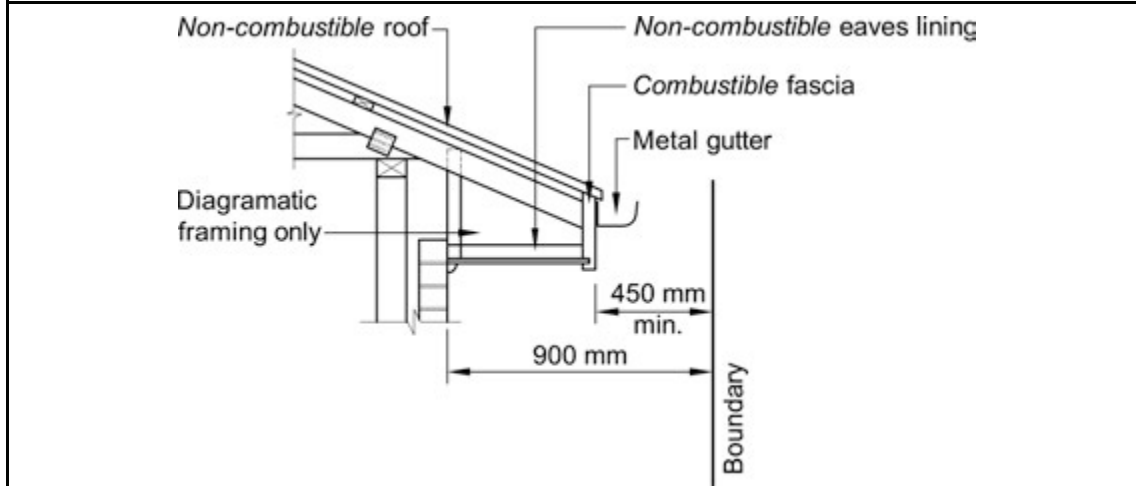

3.7.1.8 Separating walls

- (a) A *separating wall* between Class 1 buildings, or a wall that separates a Class 1 building from a Class 10a building which is not appurtenant to that Class 1 building must have an FRL of not less than 60/60/60 and—
- (i) commence at the footings or ground slab (see [Figure 3.7.1.10](#)); and
 - (ii) extend—
 - (A) if the building has a *non-combustible* roof covering, to the underside of the roof covering (see [Figure 3.7.1.10](#) and [Figure 3.7.1.11](#)); or
 - (B) if the building has a *combustible* roof covering, to not less than 450 mm above the roof covering (see [Figure 3.7.1.10](#)).
- (b) A *separating wall* of *lightweight construction* must be tested in accordance with [Specification C1.8](#) of the BCA Volume One.

FIRE SAFETY

Figure 3.7.1.10

SEPARATING WALL CONSTRUCTION

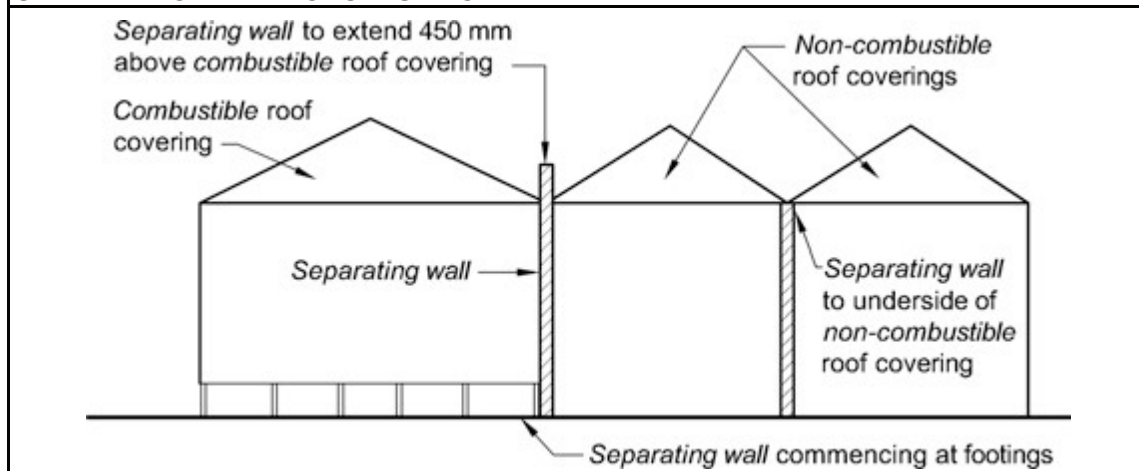

- (c) A *separating wall* complying with (a)(ii)(A)—
- (i) must not be crossed by timber or other *combustible* building elements except for roof battens with dimensions of 75x50 mm or less, or roof sarking; and
 - (ii) must have any gap between the top of the wall and the underside of the roof covering packed with mineral fibre or other suitable *fire-resisting* material.
- (d) Where a building has a masonry veneer *external wall*, any gap between the *separating wall* and the external masonry veneer must be—
- (i) not more than 50 mm; and
 - (ii) packed with a mineral fibre or other suitable fire resistant material with the packing arranged to maintain any weatherproofing requirements of Part 3.3.4.
- (e) Eaves, verandahs and similar spaces that are open to the roof space and are common to more than one Class 1 dwelling must be separated by a *non-combustible* vertical lining (see Figure 3.7.1.11 Diagram b).
- (f) Any service opening, other than those listed in (g), (h) and (i), in a *separating wall* must have construction with an FRL of not less than -/60/60.
- (g) If an electrical wire or cable penetrates a *separating wall*—
- (i) the service and building element at the penetration must be identical with a prototype assembly which has been tested in accordance with AS 4072.1 and AS 1530.4 and achieved an FRL of not less than -/60/60; or
 - (ii) the service must be installed so that—
 - (A) the opening is neatly formed, cut or drilled and no closer than 50 mm to any other service; and
 - (B) the opening is no larger in cross-section than—
 - (aa) 2000 mm² if only a single cable is accommodated and the gap between the cable and the wall is no wider than 15 mm; or
 - (bb) 500 mm² in any other case; and

FIRE SAFETY

- (C) any gap between the service and the wall is packed with mineral fibre or other suitable fire resistant material.
- (h) If an electrical switch, outlet, socket or the like is accommodated in a *separating wall*—
 - (i) the service and building element at the penetration must be identical with a prototype assembly which has been tested in accordance with AS 4072.1 and AS 1530.4 and achieved an FRL of not less than -/60/60; or
 - (ii) the service must be installed so that—
 - (A) the opening or recess must not—
 - (aa) be located opposite any point within 300 mm horizontally or 600 mm vertically of any opening or recess on the opposite side of the wall; or
 - (bb) extend beyond half the thickness of the wall; and
 - (B) any gap between the service and the wall is packed with mineral fibre or other suitable fire resistant material.
 - (i) Other than where a tested system is used in accordance with (h)(i), if an electrical switch, socket, outlet or the like is accommodated in a hollow *separating wall* (such as a stud wall, masonry *cavity* wall or a wall of hollow blockwork), the *cavity* immediately behind the service must be framed and packed with mineral fibre or other suitable fire resistant material (see **Figure 3.7.1.11** Diagram c).

Explanatory information:

It is important that any opening in a *separating wall* between Class 1 buildings not allow the free passage of fire between the buildings. On the other hand, many designs would require the installation of openings for electrical cables and outlets in these walls. **3.7.1.8(f)** therefore allows such openings provided they have an FRL of at least -/60/60 or comply with the details set out in **3.7.1.8(g)**, **(h)** and **(i)**.

3.7.1.9 Fire hazard properties

The fire hazard properties of materials used in a Class 1 building, including common floor or ceiling spaces with a Class 10 building, must comply with the following:

- (a) *Sarking-type materials* used in the roof must have a *flammability index* not greater than 5.
- (b) Flexible ductwork used for the transfer of products initiating from a heat source that contains a flame must comply with the fire hazard properties set out in AS 4254 Parts 1 and 2.

3.7.1.10 Roof lights

Combustible roof lights, skylights or the like installed in a roof or part of a roof *required* to have a *non-combustible* covering must—

- (a) have an aggregate area not more than 20% of the roof or part of the roof; and
- (b) be not less than—
 - (i) 900 mm from—
 - (A) the allotment boundary other than the boundary adjoining a road alignment or other public space; and

FIRE SAFETY

- (B) the vertical projection of a *separating wall* extending to the underside of the roof covering; and
- (ii) 1.8 m from any roof light or the like in another building on the allotment other than an appurtenant building or a detached part of the same building. (See [Figure 3.7.1.12](#)).

Figure 3.7.1.11

SEPARATING WALL CONSTRUCTION—UNDERSIDE OF NON-COMBUSTIBLE ROOF CLADDING

Diagram a.

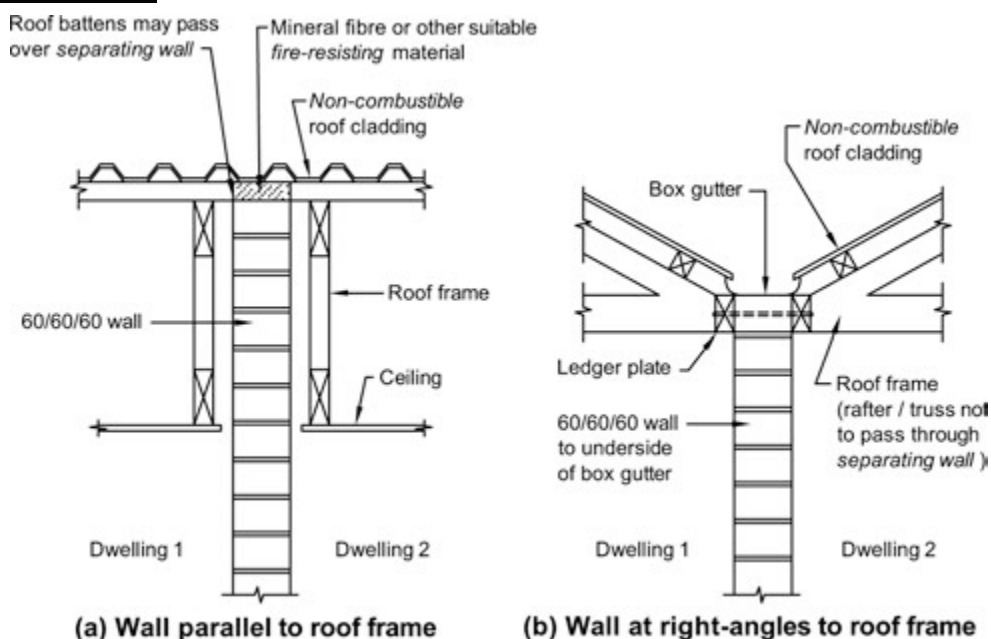

FIRE SAFETY

Figure 3.7.1.11

SEPARATING WALL CONSTRUCTION—UNDERSIDE OF NON-COMBUSTIBLE ROOF CLADDING

Diagram b.

OPTION 1 *Non-combustible* vertical lining installed between roof space of one Class 1 and the common eaves or verandah space

Elements crossing the *non-combustible* vertical lining must comply with Clause 3.7.1.8(c)(i)

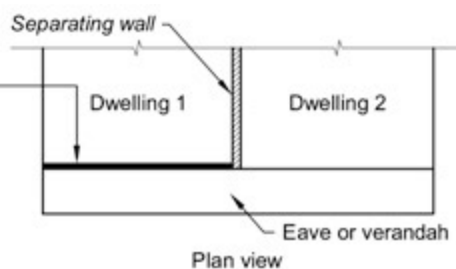

(c) Separation of dwelling and eaves / verandahs

OPTION 2 *Non-combustible* vertical lining installed in common eaves or verandah space

Elements crossing the *non-combustible* vertical lining must comply with Clause 3.7.1.8(c)(i)

Note: The *non-combustible* vertical lining need only be installed on one side of a rafter, truss or supporting framework, provided that it forms a continuous barrier with the *separating wall*

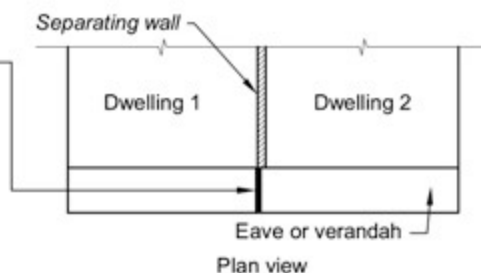

(d) Separation of eave / verandah

Diagram c.

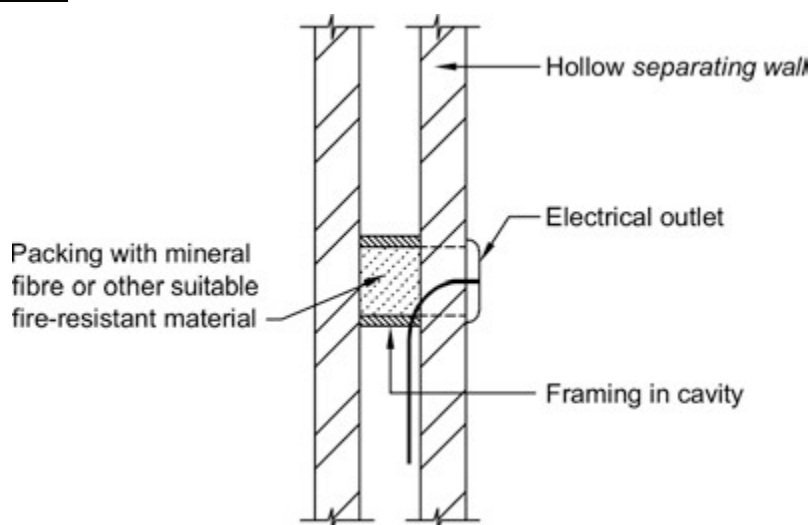

FIRE SAFETY

Figure 3.7.1.12

LOCATION OF COMBUSTIBLE ROOF LIGHTS

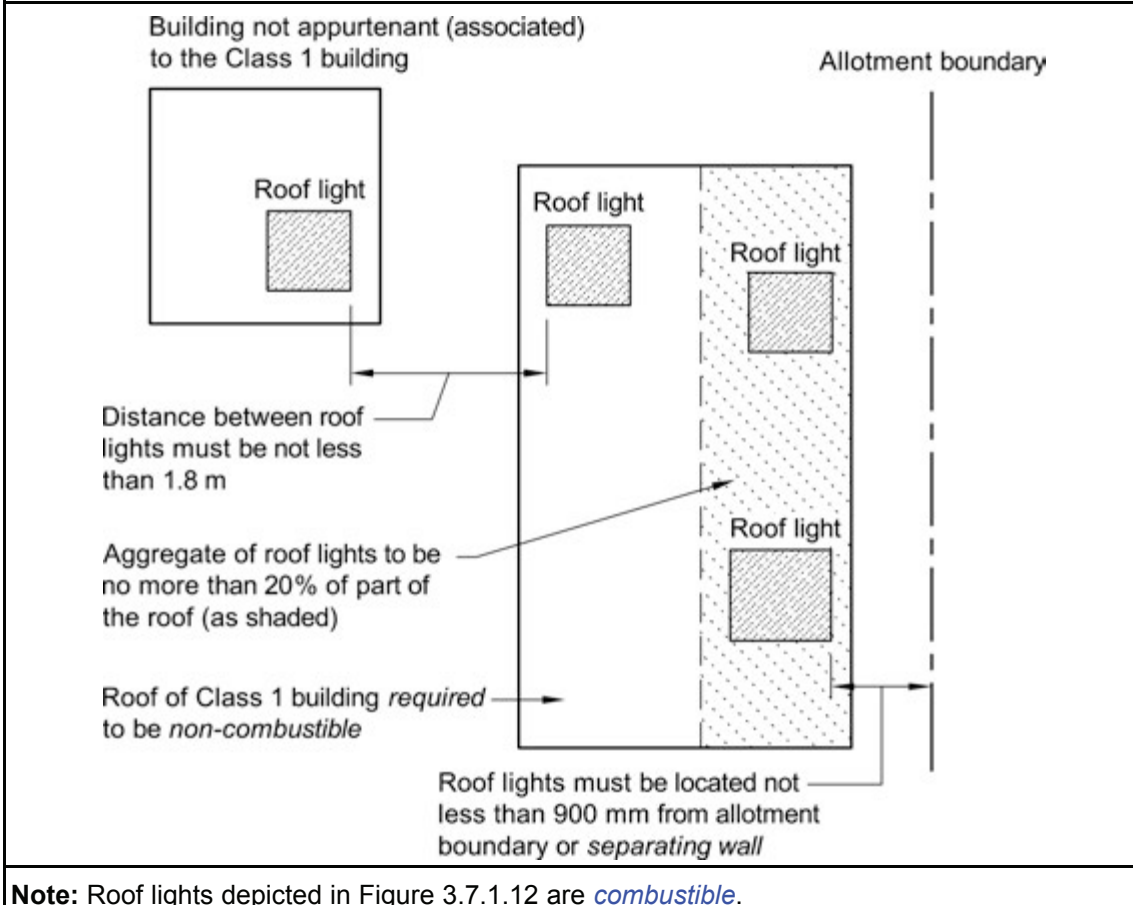

PART 3.7.2 SMOKE ALARMS

Appropriate *Performance Requirements*

Where an alternative smoke alarm system is proposed as an *Alternative Solution* to that described in **Part 3.7.2**, that proposal must comply with—

- (a) *Performance Requirement P2.3.2*; and
- (b) the relevant *Performance Requirements* determined in accordance with **1.0.10**.

Acceptable construction practice

3.7.2.1 Application

Compliance with this acceptable construction practice satisfies *Performance Requirement P2.3.2* for smoke alarms.

3.7.2.2 Requirements for smoke alarms

Smoke alarms must be—

- (a) located in—
 - (i) Class 1a buildings in accordance with **3.7.2.3**; and
 - (ii) Class 1b buildings in accordance with **3.7.2.4** and **3.7.2.5**; and
- (b) comply with AS 3786; and
- (c) connected to the consumer mains power where consumer power is supplied to the building; and
- (d) interconnected where there is more than one alarm.

3.7.2.3 Location — Class 1a buildings

Smoke alarms must be installed in a Class 1a building on or near the ceiling in—

- (a) any storey containing bedrooms—
 - (i) between each part of the dwelling containing bedrooms and the remainder of the dwelling; and
 - (ii) where bedrooms are served by a hallway, in that hallway; and
- (b) any other storey not containing bedrooms.
(see **Figure 3.7.2.1**, Diagram a and **Figure 3.7.2.2**)

3.7.2.4 Location — Class 1b buildings

In a Class 1b building, smoke alarms must be installed on or near the ceiling—

FIRE SAFETY

- (a) in every bedroom; and
- (b) in every corridor or hallway associated with a bedroom, or if there is no corridor or hallway, in an area between the bedrooms and the remainder of the building; and
- (c) on each other storey.

(see [Figure 3.7.2.1](#), Diagram b and [Figure 3.7.2.2](#))

3.7.2.5 Lighting to assist evacuation — Class 1b buildings

In a Class 1b building, a system of lighting must be installed to assist evacuation of occupants in the event of a fire, and—

- (a) be activated by the smoke alarm *required* by [3.7.2.4\(b\)](#); and
- (b) consist of—
 - (i) a light incorporated within the smoke alarm; or
 - (ii) the lighting located in the corridor, hallway or area served by the smoke alarm.

Explanatory information:

The lighting *required* by [3.7.2.5](#) may consist of the artificial lighting which may already be installed in a corridor, hallway or area, provided that lighting is activated by the smoke alarm.

Figure 3.7.2.1

LOCATION OF SMOKE ALARM

Legend: ● Smoke alarm

◻ Smoke alarm with evacuation lighting (as *required* by [3.7.2.5\(b\)\(i\)](#))

Diagram a. Class 1a buildings

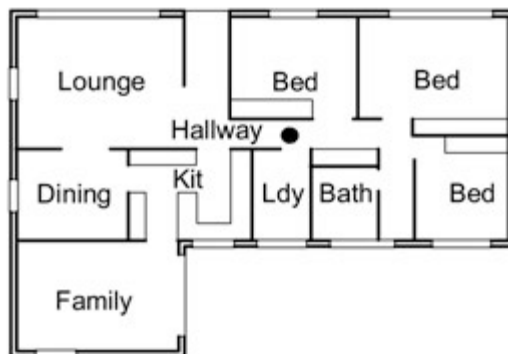

FIRE SAFETY

Figure 3.7.2.1

LOCATION OF SMOKE ALARM

Legend: ● Smoke alarm

◻ Smoke alarm with evacuation lighting (as *required* by 3.7.2.5(b)(i))

Diagram b. Class 1b buildings

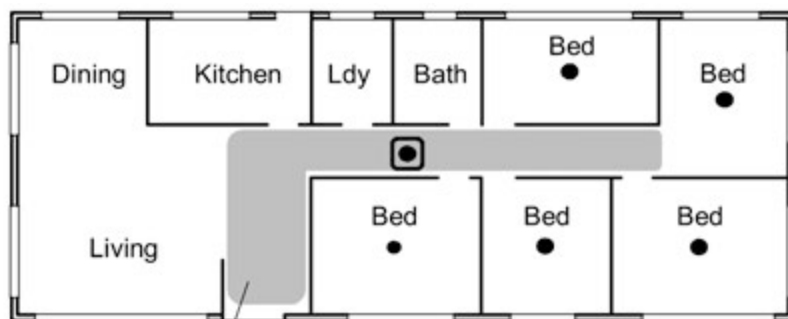

Lights in this area to be activated by smoke alarm if using 3.7.2.5(b)(ii)

Figure 3.7.2.2

LOCATION OF SMOKE ALARMS ON DIFFERENT STOREYS

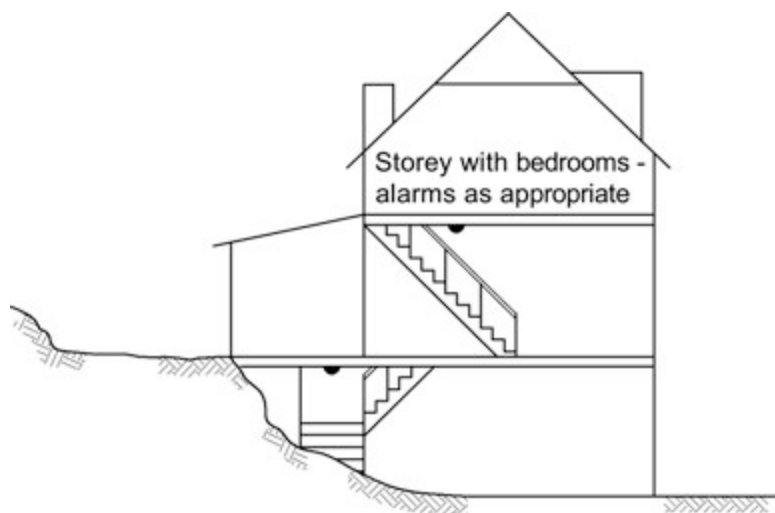

(a) Smoke alarms installed on each storey not containing bedrooms — located in the area of the stairway

Explanatory information:

1. HOW DOES A SMOKE ALARM WORK ?

There are two types of smoke alarms.

1.1 Photoelectric:

This type of smoke alarm uses a light source and photocell. As the smoke enters the detection chamber it interferes with the light beam which in turn causes the alarm to sound.

FIRE SAFETY

1.2 Ionisation:

A small amount of radioactive material is used to create an electrical current which travels through ionised air. When smoke enters the detection chamber it impedes the flow of current and causes the alarm to sound.

2. LOCATION OF SMOKE ALARMS

When deciding on the position of smoke alarms it is important to remember that they are intended to detect smoke before it reaches the sleeping occupants of a building.

The ensuing alarm is designed to wake the occupants and give them time to evacuate the building.

2.1 Added flexibility when considering detector location

As mentioned earlier, the introduction of the *Performance Requirement* gives the *appropriate authority* flexibility when considering the location of smoke alarms.

For instance, in Class 1a buildings if the *Deemed-to-Satisfy Provision* states that the smoke alarm should be located in the hallway, and there is a bathroom adjacent this location (that will potentially cause nuisance alarms) the *appropriate authority* could accept the alarm being installed in the bedroom as a suitable option using the performance clause.

This approach should also be adopted when considering sleep-outs or similar type residential buildings that are not connected to the remainder of the building by a hallway or other enclosed structure. In these situations the alarm could be located in the room itself.

2.2 Protection of sleeping areas in Class 1a buildings

The *deemed-to-satisfy provisions* require that a smoke alarm be located “between each area containing bedrooms and the remainder of the dwelling”.

In some dwellings the bedrooms are located in a common area and connected by a hallway. In this instance the alarm should be located as shown in **Figure 3.7.2.1**, Diagram a.

2.3 Location of the smoke alarm on other storeys

A smoke alarm is also required on each other storey that is not already provided with a smoke alarm. It should be noted that smoke alarms are required to be installed in other storeys even if those storeys consist of only carparking, bathrooms, laundries and the like. “Storey” in this context differs from the definition contained in BCA Volume One which excludes such spaces from being considered as storeys.

The favoured location for this alarm will be in the path of travel people will most likely take to evacuate the building. This will ensure an alarm will be raised before smoke makes the common exit path impassable. For example, if the bedrooms are on the first floor, then an alarm should be positioned near the area of the inter-connecting stair at ground level.

If the other storey is not connected to the remainder of the building (for instance a ground floor garage) then the alarm should be centrally located in the lower area. However, it may be reasonable, using a performance approach, not to install smoke alarms where the storey is predominantly open, such as the basement level of a highset house on stumps that is used for carparking or laundry purposes.

FIRE SAFETY

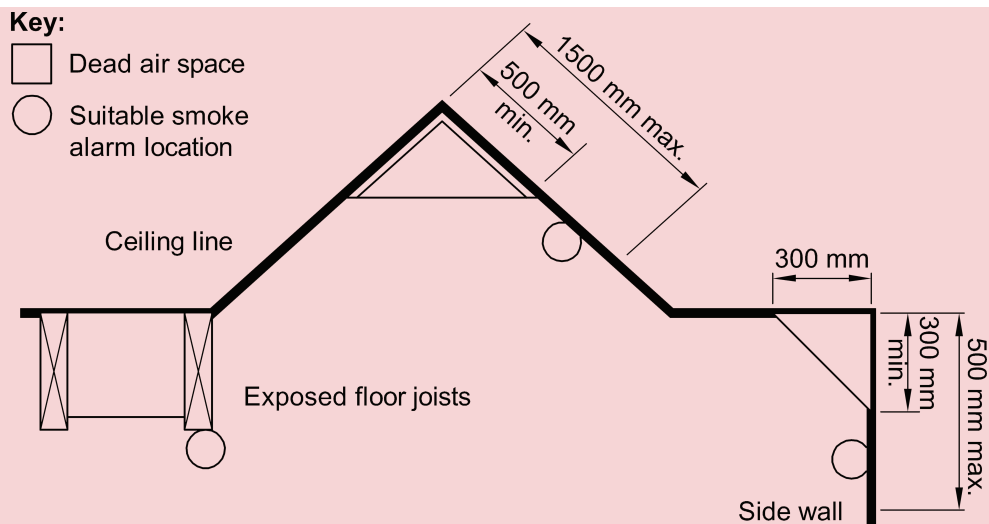

Diagram 1 — DEAD AIRSPACE AND PROPER MOUNTING OF SMOKE ALARMS ON SIDE WALLS

2.4 Installation of smoke alarms

Smoke alarms should be installed on or near the ceiling with special care being taken to avoid dead air spaces.

A dead air space is an area in which trapped hot air will prevent smoke from reaching the alarm. This space generally occurs at the apex of cathedral ceilings, the corner junction of walls and ceilings, between exposed floor joists etc. (see Diagram 1).

If it is impractical to mount the smoke alarm on the ceiling then it may be located on the wall. The recommended position is between 300 mm and 500 mm off the ceiling (see Diagram 1).

The distance from the apex of a cathedral ceiling to the top of the alarm should be between 500 mm and 1500 mm.

3. NUISANCE ALARMS

Smoke alarms are extremely sensitive and may detect smoke and moisture created by common household activities (such as burnt toast or steam from a bathroom).

Accordingly, to reduce the likelihood of nuisance alarms, the smoke alarm should not be located near cooking appliances and bathrooms. However, if it is necessary to locate alarms in these positions, an ionisation type alarm is more suitable near bathrooms, while a photoelectric alarm may be used near cooking appliances.

4. INTERCONNECTION OF SMOKE ALARMS

Alarms need to be interconnected to provide a common alarm so that if one alarm in the dwelling activates then other alarms automatically activate, which will increase the likelihood of sleeping occupants becoming aware of the detection of smoke.

PART 3.7.3 HEATING APPLIANCES

Appropriate *Performance Requirements*

Where an alternative heating appliance is proposed as an *Alternative Solution* to that described in **Part 3.7.3**, that proposal must comply with—

- (a) *Performance Requirement P2.3.3*; and
- (b) the relevant *Performance Requirements* determined in accordance with **1.0.10**.

A. Acceptable construction manuals

3.7.3.0

Performance Requirement P2.3.3 is satisfied for a heating appliance if it is installed in accordance with one of the following:

- (a) * * * * *
- (b) Domestic solid-fuel burning appliances: AS/NZS 2918.
- (c) Boilers and pressure vessels: AS/NZS 1200.

B. Acceptable construction practice

3.7.3.1 Application

Compliance with this acceptable construction practice satisfies *Performance Requirement P2.3.3* for heating appliances.

3.7.3.2 Open fireplace construction

An open fireplace must be constructed as follows (also see **Figure 3.7.3.1**):

- (a) All masonry must be constructed in accordance with **Part 3.3**.
- (b) The front hearth must be constructed of stone, concrete, masonry or similar material so that—
 - (i) it extends not less than 300 mm beyond the front of the fireplace opening and not less than 150 mm beyond each side of that opening; and
 - (ii) its upper surface does not slope away from the back hearth.
- (c) The base of the back hearth must be constructed of stone, concrete, masonry or similar material and any *combustible* flooring or framing members must be situated not less than 150 mm from its upper surface.

FIRE SAFETY

- (d) The fireplace rear and side walls up to a height of 300 mm above the underside of the arch or lintel—
- (i) must be constructed in 2 separate leaves of solid masonry with an overall thickness not less than 180 mm thick, excluding any *cavity*; and
 - (ii) must not consist of concrete block masonry in the construction of the inner leaf; and
 - (iii) must be constructed of masonry units with a net volume, excluding cored and similar holes, not less than 75% of their gross volume, measured on the overall rectangular shape of the units, and with an actual thickness of not less than 100 mm.
- (e) The fireplace must be constructed on footings complying with **3.2.5.5**.

FIRE SAFETY

Figure 3.7.3.1

FIRE PLACE CLEARANCE FROM COMBUSTIBLE MATERIALS

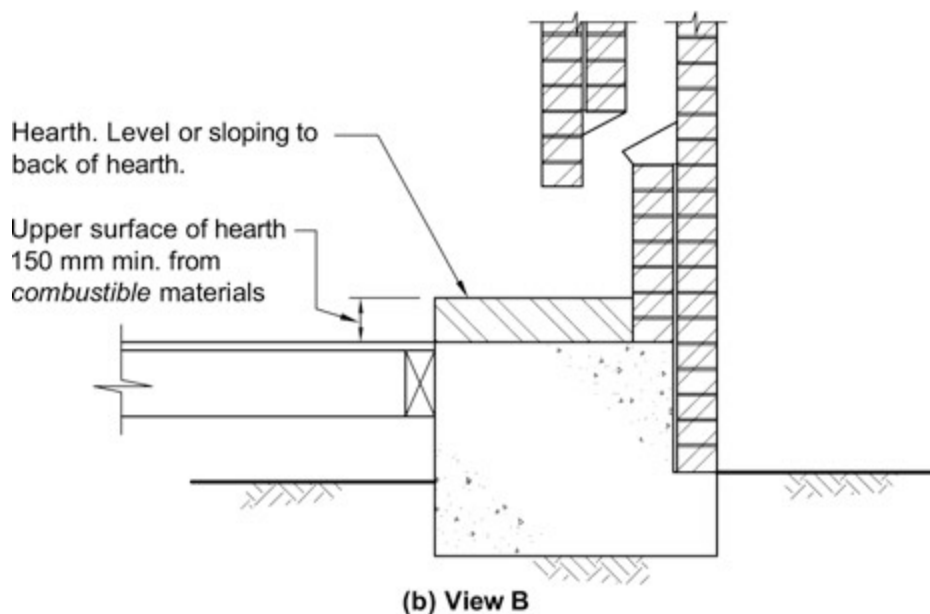
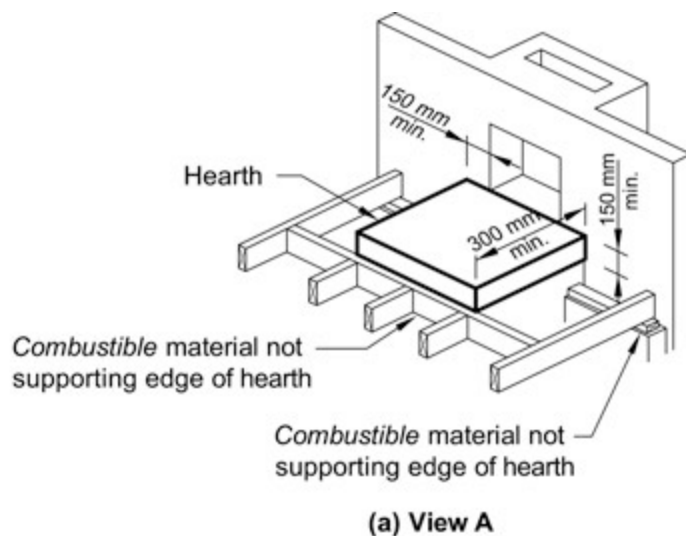

3.7.3.3 Chimney construction

The construction of a chimney must comply with [Part 3.3](#) and the following:

- The walls of the chimney above the level referred to in [3.7.3.2\(d\)](#) must be lined internally to a thickness of not less than 10 mm with composition mortar parging.
- The chimney or flue must terminate not less than 300 mm above the highest part of the building within a horizontal distance of 3.6 m of the chimney or flue (see [Figure 3.7.3.2](#)).

FIRE SAFETY

Explanatory information:

The requirements of this Part are to be read in conjunction with the building sealing requirements in [Part 3.12.3](#). However, it should be noted that [Part 3.12.3](#) does not apply in all States and Territories.

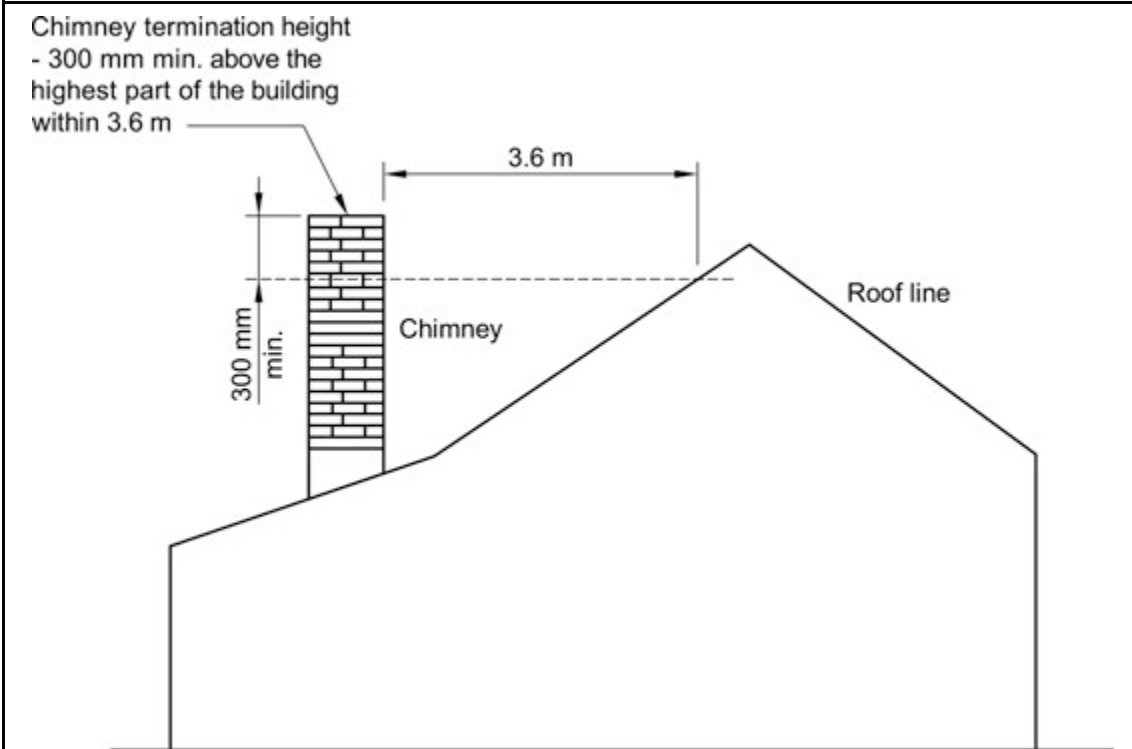
Figure 3.7.3.2**SECTION SHOWING HEIGHT AND POSITION OF CHIMNEY****3.7.3.4 Installation of insert fireplaces and flues**

An insert fireplace and flue must comply with the following:

- The insert fireplace must be tested and passed the tests required by AS/NZS 2918.
- The insert fireplace must be fitted into a masonry fireplace (including chimney) constructed in accordance with [Part 3.3](#).
- The flue must be double skin and have been tested and pass the tests required by AS/NZS 2918.

FIRE SAFETY

Figure 3.7.3.3

TYPICAL INSTALLATION OF FIRE PLACE FLUE INSERTS

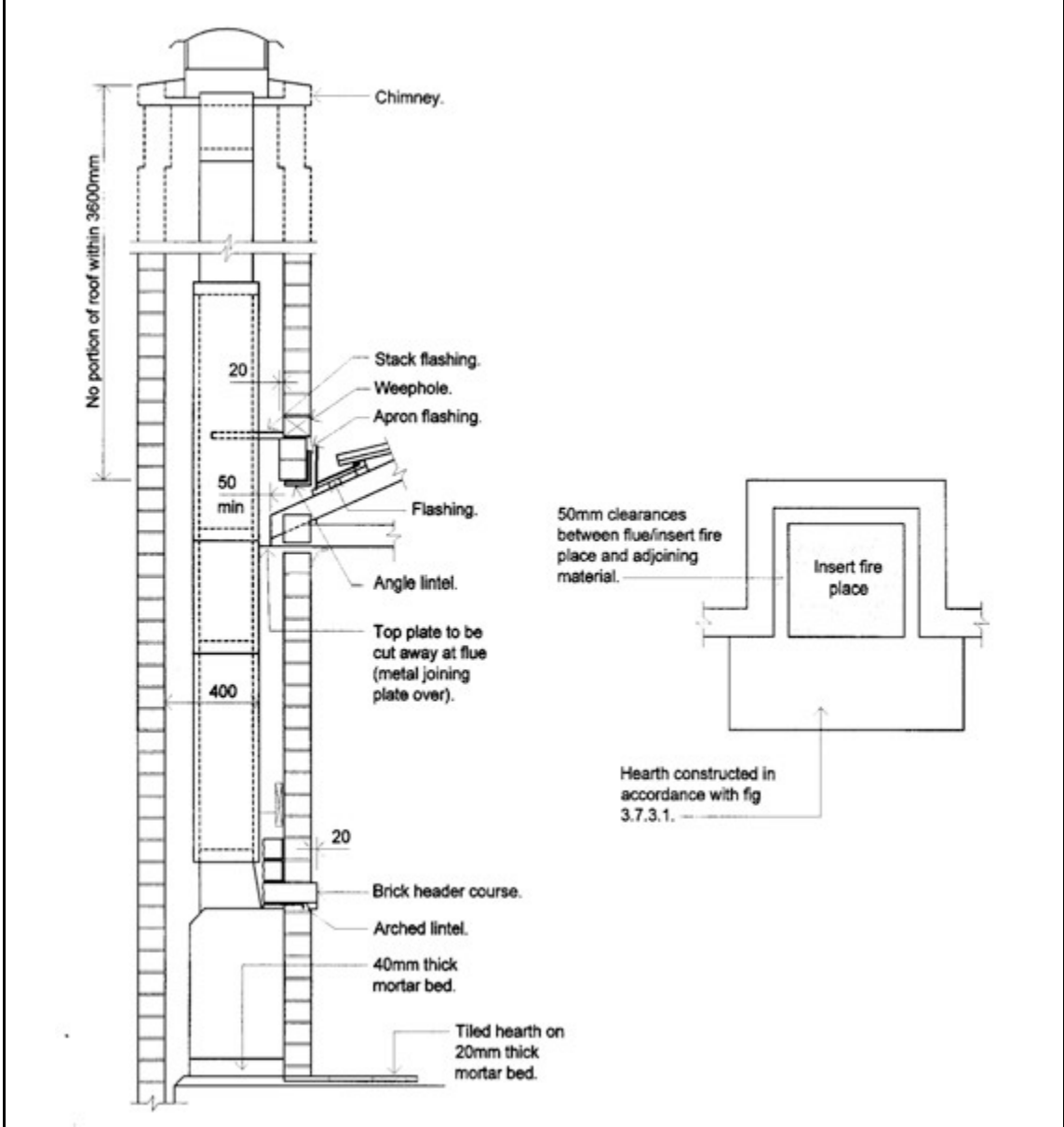

- (d) There must be a clearance of 50 mm between the outer flue and adjacent materials.
- (e) The flue must terminate in accordance with [Figure 3.7.3.2](#).
- (f) The hearth must be constructed in accordance with [3.7.3.2\(b\)](#), [\(c\)](#) and [\(e\)](#).

3.7.3.5 Installation of free standing heating appliances

The installation of a free standing heating appliance must comply with the following:

- (a) The appliance must—

FIRE SAFETY

- (i) be installed with safety clearances determined by testing in accordance with AS/NZS 2918; or
 - (ii) be located not less than 1.2 m from adjoining walls (other than a masonry wall); or
 - (iii) have a heat shield between the adjoining wall (other than a masonry wall) and the heating appliance in accordance with [Figure 3.7.3.4](#).
- (b) Where a heat shield is used, it must be installed in accordance with [Figure 3.7.3.4](#) and it must be not less than 90 mm thick masonry constructed in accordance with [Part 3.3](#).
- (c) The heating appliance must be installed on a hearth—
- (i) complying with [3.7.3.2\(b\)](#) and [\(c\)](#), except that the hearth must extend 400 mm from the appliance in accordance with [Figure 3.7.3.4](#); or
 - (ii) where a heat shield is installed, in accordance with [Figure 3.7.3.4](#).
- (d) The flue must—
- (i) have been tested and passed the tests required by AS/NZS 2918; and
 - (ii) be installed in accordance with [Figure 3.7.3.5](#); and
 - (iii) terminate in accordance with [Figure 3.7.3.2](#).
- (e) Flue types or installation of flues in areas not specifically covered by [Figures 3.7.3.4](#) and [3.7.3.5](#) must be installed in accordance with AS/NZS 2918.

Figure 3.7.3.4

ACCEPTABLE LOCATION OF FREE STANDING HEATING APPLIANCES

Diagram a.

ELEVATION

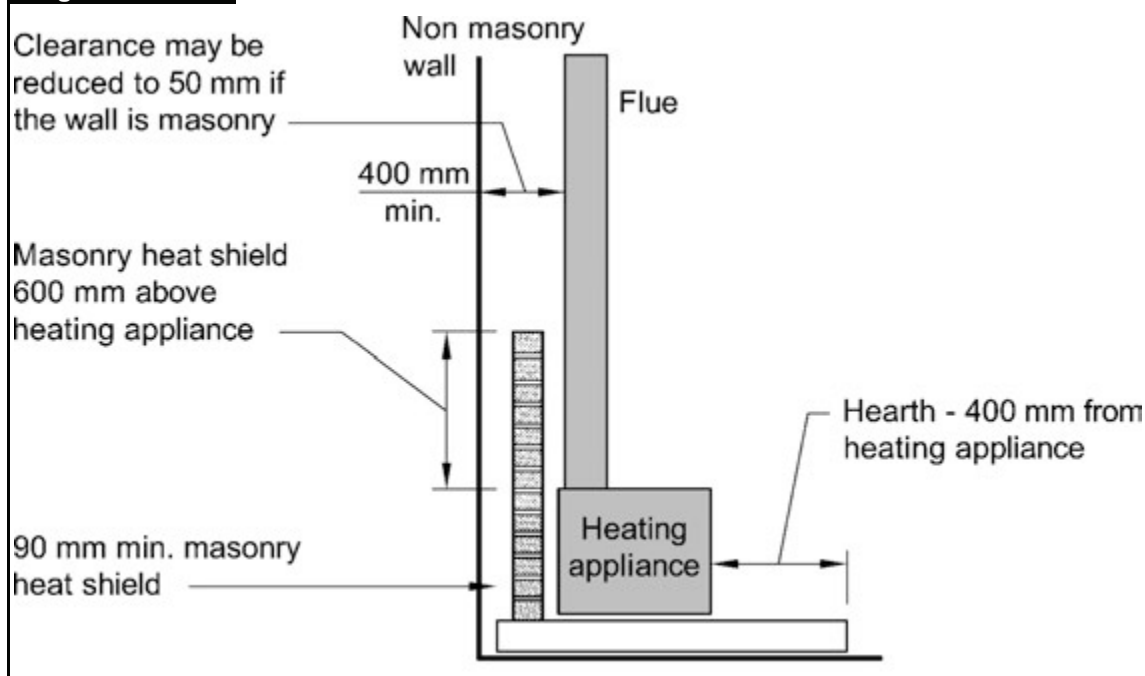

FIRE SAFETY

Figure 3.7.3.4

ACCEPTABLE LOCATION OF FREE STANDING HEATING APPLIANCES

Diagram b. PLAN VIEW

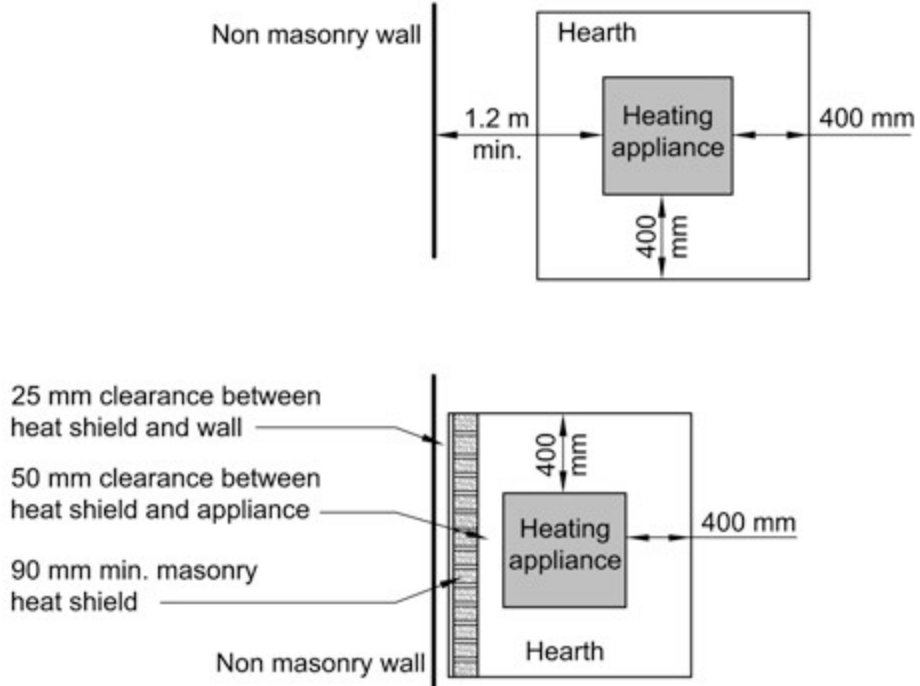

FIRE SAFETY

Figure 3.7.3.5

ACCEPTABLE FLUE INSTALLATION DETAILS

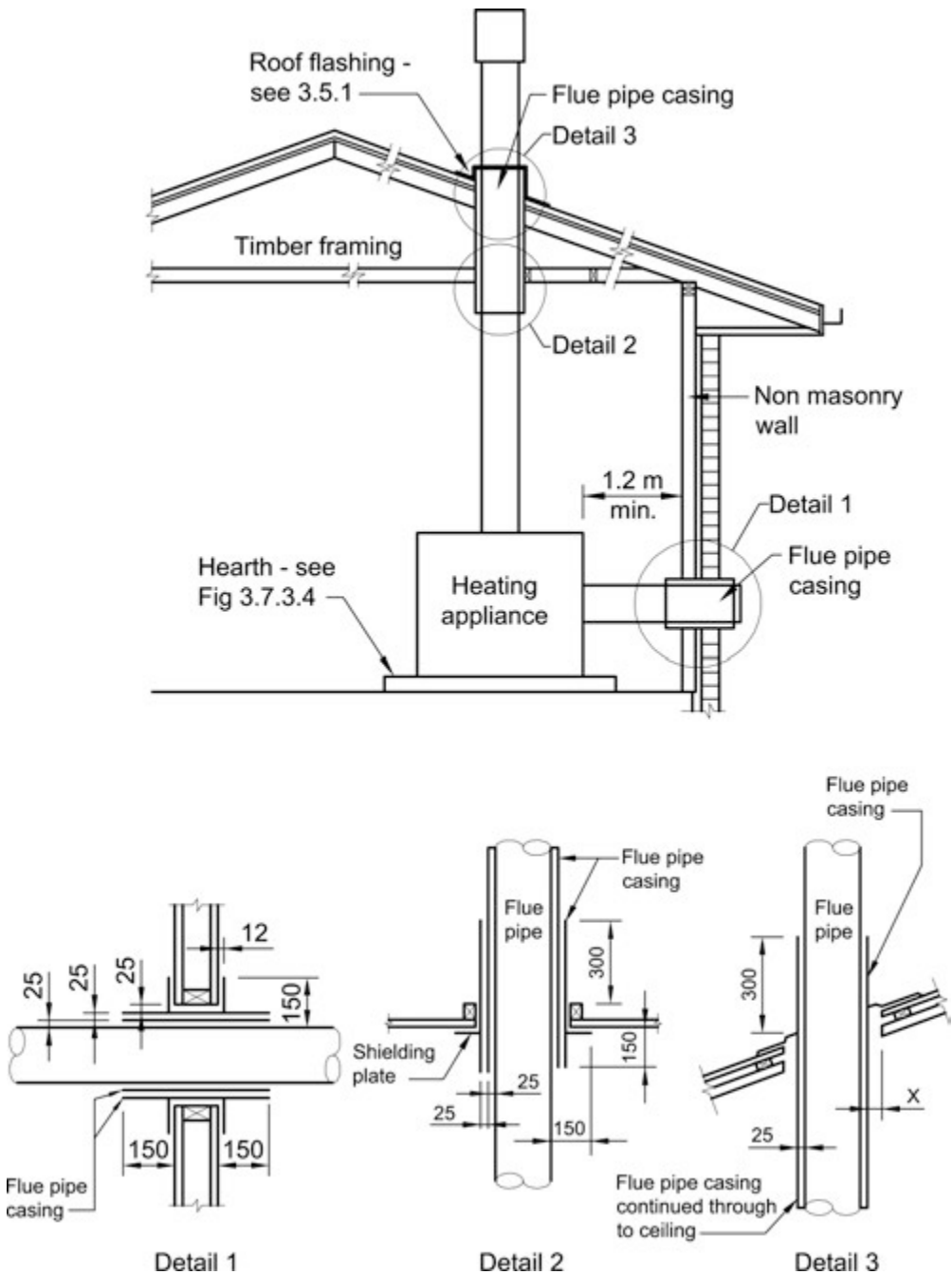

Note: Flue pipe size — 150 mm maximum (for other sizes see AS/NZS 2918).

PART 3.7.4 BUSHFIRE AREAS

Appropriate *Performance Requirements*

Where an alternative bushfire protection design is proposed as an *Alternative Solution* to that described in **Part 3.7.4**, that proposal must comply with—

- (a) *Performance Requirement P2.3.4*; and
- (b) the relevant *Performance Requirements* determined in accordance with **1.0.10**.

A. Acceptable construction manual

3.7.4.0

Performance Requirement P2.3.4 is satisfied for—

- (a) a Class 1 building; or
- (b) a Class 10a building or deck associated with a Class 1 building, located in a *designated bushfire prone area* if it is constructed in accordance with—
- (c) AS 3959; or
- (d) NASH Standard 'Steel Framed Construction in Bushfire Areas'.

STATE AND TERRITORY VARIATIONS

3.7.4.0 is replaced with the following clause in New South Wales:

Performance Requirement P2.3.4 is satisfied, in a *designated bushfire prone area*, for—

- (a) a Class 1 building; or
- (b) a Class 10a building or deck associated with a Class 1 building, if it is constructed in accordance with the following:
 - (c) AS 3959, except for Section 9 Construction for Bushfire Attack Level FZ (BAL-FZ); or
 - (d) NASH Standard 'Steel Framed Construction in Bushfire Areas'; except for buildings subject to Bushfire Attack Level FZ (BAL-FZ); or
 - (e) the requirements of (c) or (d) above as modified by the development consent following consultation with the NSW Rural Fire Service under section 79BA of the Environmental Planning and Assessment Act 1979; or
 - (f) the requirements of (c) or (d) above as modified by development consent with a bushfire safety authority issued under section 100B of the Rural Fires Act 1997 for the purposes of integrated development.

FIRE SAFETY

Explanatory information:

In New South Wales, buildings subject to BAL-FZ must comply with specific conditions of development consent for construction at this level.

3.7.4.0 is replaced with the following clause in Queensland:

- (a) Subject to (b), *Performance Requirement P2.3.4* is satisfied for—
- (i) a Class 1 building; or
 - (ii) a Class 10a building or deck associated with a Class 1 building, located in a *designated bushfire prone area* if it is constructed in accordance with AS 3959.
- (b) The requirements of (a) do not apply when the classified vegetation is Group F rainforest (excluding wet sclerophyll forest types), mangrove communities and grasslands under 300 mm high.

3.7.4.0 does not apply in South Australia.**3.7.4.0 is replaced with the following clause in Tasmania:**

Performance Requirement P2.3.4 is satisfied for a Class 1 building or a Class 10a building or deck associated with a Class 1 building located in a *designated bushfire prone area* if—

- (a) it is constructed in accordance with—
- (i) AS 3959; or
 - (ii) NASH Standard 'Steel Framed Construction in Bushfire Areas'; except for buildings subject to Bushfire Attack Level FZ (BAL-FZ); and
- (b) vehicle access is provided to the building in accordance with **Tas 3.7.4.1**; and
- (c) a water supply is provided to the building in accordance with **Tas 3.7.4.2**.

B. Acceptable construction practice**STATE AND TERRITORY VARIATIONS**

In South Australia insert SA 3.7.4.1, SA 3.7.4.2, SA 3.7.4.3 and Table SA 3.7.4.1 as follows:

SA 3.7.4.1 Application

Compliance with this acceptable construction practice satisfies *Performance Requirement P2.3.4* for:

- (a) a Class 1 building; or
- (b) a Class 10a building or deck located within 6 m of a Class 1 building that is *required* to comply with this Part, constructed in a *designated bushfire prone area*.

SA 3.7.4.2 Bushfire attack levels

Where a *site* is located in a *designated bushfire prone area*, the bushfire attack level that applies to the *site* is—

- (a) for areas identified as General Bushfire Risk areas in South Australian Development Plans, the BAL - Low bushfire attack level; and
- (b) for areas identified as Medium Bushfire Risk areas in South Australian Development Plans, the BAL - 12.5 bushfire attack level; and
- (c) for areas identified as High Bushfire Risk areas in South Australian Development Plans, the bushfire attack level assessed for the *site* in accordance with the requirements of AS 3959; and
- (d) for Excluded Areas within 500 m of a High Bushfire Risk area, as identified in South Australian Development Plans, the BAL - Low bushfire attack level; and
- (e) for Excluded Areas within 100 m of a High Bushfire Risk area, as identified in South Australian Development Plans, the bushfire attack level assessed for the *site* in accordance with AS 3959.

SA 3.7.4.3 Construction requirements

- (a) A Class 1 building, or a Class 10a building or deck *required* to comply with this Part, must be constructed in accordance with **Table SA 3.7.4.1** for the bushfire attack level for the *site*.
- (b) A Class 10a building or deck is not *required* to comply with **SA 3.7.4.3(a)** if it is separated from a Class 1 building by—
 - (i) for a Class 10a building or deck attached to or sharing a common roof space with a Class 1 building, a wall that extends from the footings or concrete slab to the underside of a *non-combustible* roof covering and complies with one of the following:
 - (A) The wall has an FRL of not less than 60/60/60 for *loadbearing* walls, and -/60/60 for non-*loadbearing* walls when tested from the Class 10 side.
 - (B) The wall is of masonry, earth wall or masonry-veneer construction where the masonry leaf is not less than 90 mm in thickness.
 - (ii) for a Class 10a building or deck located below a Class 1 building, separating floor and/or wall construction complying with one of the following:
 - (A) The floor and/or wall has an FRL of not less than 60/60/60 for *loadbearing* construction, and -/60/60 for non-*loadbearing* construction when tested from the Class 10 side.
 - (B) Where part or all of the separating construction is a wall, the wall need not comply with **(A)** if it complies with **SA 3.7.4.3(b)(i)(B)**.
 - (iii) for a Class 10a building or deck located within 6 m of a Class 1 building, comply with **SA 3.7.4.3(b)(i)**.
- (c) Openings in separating construction referred to in **SA 3.7.4.3(b)(i)** and **(ii)** must comply with the following:
 - (i) Doorways must be protected by -/60/30 self-closing fire doors.
 - (ii) *Windows* must be protected by -/60/- fire *windows* permanently fixed in the closed position.
 - (iii) Other openings (excluding control and construction joints, sub-floor vents, weepholes and penetrations for pipes and conduits) must be protected by construction with an FRL of not less than -/60/-.

- (d) For the purposes of **Table SA 3.7.4.1** bushfire-resisting timber is timber that is in solid, laminated or reconstituted form that meets the criteria specified in Appendix F of AS 3959.
- (e) Where any material, element of construction or system satisfies the test criteria of either AS 1530.8.1, for BAL — 12.5, BAL — 29 and BAL — 40 and AS 1530.8.2 for BAL — FZ, it satisfies the requirements of that BAL.
- (f) If any material, element of construction or system satisfies the test criteria without screening for ember protection, the requirements for screening of openable parts of *windows* must still apply.
- (g) Polycarbonate may be used as roof sheeting for Class 10a buildings located within 6 m of a Class 1 building for BAL – Low, BAL – 12.5, BAL – 19 and BAL – 29 *sites*.

Table SA 3.7.4.1 CONSTRUCTION REQUIREMENTS FOR BAL – LOW, BAL – 12.5, BAL – 19, BAL – 29, BAL – 40 and BAL – FZ SITES

FLOOR SYSTEMS	
1.	BAL — Low
<p>A flooring system must comply with one or a combination of the following:</p> <ul style="list-style-type: none"> (a) A concrete slab-on-ground. (b) A suspended concrete floor. (c) A framed floor where, if the underside is greater than 600 mm above finished ground or paving level, the sub-floor space is enclosed with— <ul style="list-style-type: none"> (i) a <i>non-combustible</i> sheet material. If fibre-reinforced cement sheets are used for this purpose, the sheets must have a minimum thickness of 6 mm; or (ii) a wall that extends around the perimeter of the floor from the underside of the lowest framing member to finished ground or paving level and is constructed in accordance with clauses 7.4.1 and 7.4.2 of the BAL – 29 requirements of AS 3959. <i>Sarking-type material</i> must have a <i>Flammability Index</i> of not more than 5; or (iii) a vertical <i>non-combustible</i> sheet material that extends around the perimeter of the floor from the underside of the lowest framing member to finished ground or paving level. If fibre-reinforced cement sheets are used for this purpose, the sheets must have a minimum thickness of 6 mm. (d) A framed floor where, if any joist and/or bearer is less than 600 mm above finished ground or paving level, the sub-floor space is— <ul style="list-style-type: none"> (i) if unenclosed, constructed from flooring materials, including bearers, joists and flooring that comply with clause 7.3.2.2 (a) and (b) of the BAL — 29 requirements of AS 3959; or (ii) enclosed with a wall complying with (c)(ii); or (iii) enclosed with <i>non-combustible</i> sheet material that extends not less than 400 mm above finished ground or paving level and to the bottom of the wall sheeting material. If fibre reinforced cement sheets are used for this purpose, the sheets must have a minimum thickness of 6 mm. <p>A flooring system complying with (c) or (d)(ii) or (iii) must have all of the joints in the external surface of walls covered, sealed, overlapped, backed or butt-jointed to prevent gaps greater than 3 mm. Alternatively, <i>sarking-type material</i> can be applied over the frame prior to fixing any external sheeting.</p>	

FIRE SAFETY

Table SA 3.7.4.1 CONSTRUCTION REQUIREMENTS FOR BAL – Low, BAL – 12.5, BAL – 19, BAL – 29, BAL – 40 and BAL – FZ SITES — continued

2. BAL — 12.5
As per BAL — Low requirements of this table, with the following variation—
(a) Aluminium mesh or aluminium perforated sheet must not be used to enclose a subfloor space.
3. BAL — 19
As per BAL — Low requirements of this table, with the following variation—
(a) Aluminium mesh or aluminium perforated sheet must not be used to enclose a subfloor space.
4. BAL — 29
As per BAL — Low requirements of this table, with the following variation—
(a) Aluminium mesh or aluminium perforated sheet must not be used to enclose a subfloor space.
5. BAL — 40
A flooring system must comply with clause 8.3 of the BAL — 40 requirements of AS 3959 with the following variation:
(a) Where a wall is used to enclose the sub-floor space, any <i>required sarking-type material</i> must have a <i>Flammability Index</i> of not more than 5.
(b) The sub-floor space of a framed floor must not be enclosed with mesh or perforated sheet made from corrosion-resistant steel, bronze or aluminium.
6. BAL — FZ
A flooring system must comply with clause 9.3 of the BAL – FZ requirements of AS 3959 with the following variation—
(a) Where a wall is used to enclose the sub-floor space, any <i>required sarking-type material</i> must have a <i>Flammability Index</i> of not more than 5.
(b) The sub-floor space of a framed floor must not be enclosed with mesh or perforated sheet made from corrosion-resistant steel, bronze or aluminium.
SUPPORTING POSTS, COLUMNS, STUMPS, PIERS AND POLES (except in sub-floor spaces enclosed by aluminium mesh or aluminium perforated sheet as described in FLOORING SYSTEMS 1 BAL Low (d))
1. BAL — Low
Supporting posts, columns, stumps, piers and poles must comply with one or a combination of the following:
(a) A <i>non-combustible</i> material.
(b) Bushfire-resisting timber for not less than 400 mm above finished ground or paving level.
(c) Timber mounted on metal stirrups with a clearance of not less than 75 mm above finished ground or paving level.
2. BAL — 12.5
As per BAL — Low requirements in this table.

FIRE SAFETY

Table SA 3.7.4.1 CONSTRUCTION REQUIREMENTS FOR BAL – LOW, BAL – 12.5, BAL – 19, BAL – 29, BAL – 40 and BAL – FZ SITES — continued

3. BAL — 19
As per BAL — Low requirements in this table.
4. BAL — 29
Supporting posts, columns, stumps, piers and poles must comply with clause 7.2 of the BAL — 29 requirements of AS 3959.
5. BAL — 40
Supporting posts, columns, stumps, piers and poles must comply with clause 8.2 of the BAL — 40 requirements of AS 3959.
6. BAL — FZ
Supporting posts, columns, stumps, piers and poles must comply with clause 9.2 of the BAL — FZ requirements of AS 3959.
EXTERNAL WALLS
1. BAL — Low
No requirements.
2. BAL — 12.5
The exposed components of <i>external walls</i> must comply with one or a combination of the following:
(a) Clauses 7.4.1(a) and 7.4.2 of the BAL – 29 requirements of AS 3959 and any <i>sarking-type material</i> must have a <i>Flammability Index</i> of not more than 5.
(b) A timber or steel-framed wall that—
(i) is sarked on the outside of the frame with <i>sarking-type material</i> having a <i>Flammability Index</i> of not more than 5; and
(ii) complies with clauses 5.4.1 and 5.4.2 of the BAL — 12.5 requirements of AS 3959.
3. BAL — 19
The exposed components of <i>external walls</i> must comply with one or a combination of the following:
(a) Clauses 7.4.1(a) and 7.4.2 of the BAL — 29 requirements of AS 3959 and any <i>sarking-type material</i> must have a <i>Flammability Index</i> of not more than 5.
(b) A timber or steel-framed wall that—
(i) is sarked on the outside of the frame with <i>sarking-type material</i> having a <i>Flammability Index</i> of not more than 5; and
(ii) complies with clauses 6.4.1 and 6.4.2 of the BAL — 19 requirements of AS 3959.
4. BAL — 29
The exposed components of <i>external walls</i> must comply with clauses 7.4.1 and 7.4.2 of the BAL — 29 requirements of AS 3959 and any <i>sarking-type material</i> must have a <i>Flammability Index</i> of not more than 5.

FIRE SAFETY

Table SA 3.7.4.1 CONSTRUCTION REQUIREMENTS FOR BAL – LOW, BAL – 12.5, BAL – 19, BAL – 29, BAL – 40 and BAL – FZ SITES — continued

5. BAL — 40
The exposed components of <i>external walls</i> must comply with clauses 8.4.1 and 8.4.2 of the BAL — 40 requirements of AS 3959 and any <i>sarking-type material</i> must have a <i>Flammability Index</i> of not more than 5.
6. BAL — FZ
The exposed components of <i>external walls</i> must comply with clauses 9.4.1 and 9.4.2 of the BAL — FZ requirements of AS 3959 and any <i>sarking-type material</i> must have a <i>Flammability Index</i> of not more than 5.
WINDOWS
1. BAL — Low
No requirements.
2. BAL — 12.5
<i>Window</i> assemblies, and shutters and screens where fitted, must comply with clauses 5.5.1, 5.5.1A and 5.5.2 of the BAL — 12.5 requirements of AS 3959.
3. BAL — 19
<i>Window</i> assemblies, and shutters and screens where fitted, must comply with clauses 6.5.1, 6.5.1A and 6.5.2 of the BAL — 19 requirements of AS 3959 with the following variations:
(a) Aluminium mesh must not be used in the <i>window</i> screens.
(b) Where leadlight <i>windows</i> are installed they must be protected by <i>non-combustible</i> shutters or toughened glass.
(c) Where timber is used, it must be bushfire-resisting timber.
4. BAL — 29
<i>Window</i> assemblies, and shutters and screens where fitted, must comply with clauses 7.5.1, 7.5.1A and 7.5.2(a) or (b)(i), (ii), (iii) and (v) of the BAL — 29 requirements of AS 3959 with the following variation:
(a) Aluminium mesh must not be used in the <i>window</i> screens.
5. BAL — 40
<i>Window</i> assemblies, and shutters and screens where fitted, must comply with clauses 8.5.1, 8.5.1A and 8.5.2 of the BAL — 40 requirements of AS 3959.
6. BAL — FZ
<i>Window</i> assemblies, and shutters and screens where fitted, must comply with clauses 9.5.1, 9.5.1A and 9.5.2 of the BAL — FZ requirements of AS 3959.
EXTERNAL DOORS
(including side-hung external doors such as French doors, panel fold and bi-fold doors, sliding doors and garage doors)
1. BAL — Low
No requirements.
2. BAL — 12.5

FIRE SAFETY

Table SA 3.7.4.1 CONSTRUCTION REQUIREMENTS FOR BAL – LOW, BAL – 12.5, BAL – 19, BAL – 29, BAL – 40 and BAL – FZ SITES — continued

Doors and door frames, and shutters and screens where fitted, must comply with clauses 5.5.1, 5.5.1A and 5.5.3, 5.5.4 and 5.5.5 of the BAL — 12.5 requirements of AS 3959.	
3.	BAL — 19
Doors and door frames, and shutters and screens where fitted, must comply with clauses 6.5.1, 6.5.1A and 6.5.3, 6.5.4 and 6.5.5 of the BAL — 19 requirements of AS 3959, with the following variation:	
(a) Aluminium mesh must not be used in the door screens.	
4.	BAL — 29
Doors and door frames, and shutters and screens where fitted, must comply with clauses 7.5.1, 7.5.1A and 7.5.3(a) or (b) or (c)(i)(A), (C) or (D), (ii), (iii), (iv), (v), (vi) and (vii), 7.5.4 and 7.5.5 of the BAL — 29 requirements of AS 3959, with the following variations:	
(a) Aluminium mesh must not be used in the door screens.	
(b) If shutters are used for side-hung or sliding doors, they must be <i>non-combustible</i> .	
(c) Side-hung doors must be solid-core with a minimum thickness of 35 mm.	
5.	BAL — 40
Doors and door frames, and shutters and screens where fitted, must comply with clauses 8.5.1, 8.5.1A and 8.5.3(a) or (b)(i)(A), (ii), (iii), (v), (vi), (vii) and (viii), 8.5.4 and 8.5.5 of the BAL — 40 requirements of AS 3959.	
6.	BAL — FZ
Doors and door frames, and shutters and screens where fitted, must comply with clauses 9.5.1, 9.5.1A and 9.5.3, 9.5.4 and 9.5.5 of the BAL — FZ requirements of AS 3959.	
VENTS AND WEEPHOLES	
(including vents and weepholes located in external walls and sub-floor spaces)	
1.	BAL — Low
Vents to sub-floor spaces and weepholes must be fitted with ember guards made from corrosion-resistant steel, bronze or aluminium mesh or perforated sheet with a maximum aperture size of 2 mm.	
2.	BAL — 12.5
As per the BAL — Low requirements of this table.	
3.	BAL — 19
As per the BAL — Low requirements of this table with the following variation:	
(a) Aluminium mesh or aluminium perforated sheet must not be used for the ember guards.	
4.	BAL — 29
As per the BAL — 19 requirements of this table.	
5.	BAL — 40
As per the BAL — 19 requirements of this table.	
6.	BAL — FZ

FIRE SAFETY

Table SA 3.7.4.1 CONSTRUCTION REQUIREMENTS FOR BAL – LOW, BAL – 12.5, BAL – 19, BAL – 29, BAL – 40 and BAL – FZ SITES — continued

As per the BAL – 19 requirements of this table.	
ROOFS	
(including verandahs and attached carport roofs, eaves linings, fascias, gables)	
1. BAL — Low	
No requirements.	
2. BAL — 12.5	
Roofs must comply with clauses 5.6.1, 5.6.2, 5.6.3, 5.6.4 and 5.6.6 of the BAL — 12.5 requirements of AS 3959 with the following variations:	
(a)	Aluminium mesh or aluminium perforated sheet must not be used for screening purposes.
(b)	Any <i>sarking-type material</i> must have a <i>Flammability Index</i> of not more than 5.
3. BAL — 19	
Roofs must comply with clauses 6.6.1, 6.6.2, 6.6.3, 6.6.4 and 6.6.6 of the BAL — 19 requirements of AS 3959 with the following variations:	
(a)	Aluminium mesh or aluminium perforated sheet must not be used for screening purposes.
(b)	Any <i>sarking-type material</i> must have a <i>Flammability Index</i> of not more than 5.
(c)	Fascias and bargeboards must be—
(i)	<i>non-combustible</i> ; or
(ii)	bushfire-resisting timber; or
(iii)	a combination of (i) and (ii).
(d)	Timber eaves lining and joining strips in linings, fascias and gables must be of bushfire-resisting timber.
4. BAL — 29	
Roofs must comply with clauses 7.6.1, 7.6.2, 7.6.3, 7.6.4 and 7.6.6 of the BAL — 29 requirements of AS 3959 with the following variations:	
(a)	Aluminium mesh or aluminium perforated sheet must not be used for screening purposes.
(b)	Any <i>sarking-type material</i> must have a <i>Flammability Index</i> of not more than 5.
(c)	Fascias and bargeboards must be—
(i)	<i>non-combustible</i> ; or
(ii)	bushfire-resisting timber; or
(iii)	a combination of (i) and (ii).
(d)	Joining strips in lining, fascias and gables must be of bushfire-resisting timber.
(e)	Fibre-reinforced cement or aluminium must not be used for roof sheeting or fascias.
(f)	Aluminium must not be used for eaves lining.
5. BAL — 40	

FIRE SAFETY

Table SA 3.7.4.1 CONSTRUCTION REQUIREMENTS FOR BAL – LOW, BAL – 12.5, BAL – 19, BAL – 29, BAL – 40 and BAL – FZ SITES — continued

<p>Roofs must comply with clauses 8.6.1, 8.6.2, 8.6.3, 8.6.4 and 8.6.6 of the BAL — 40 requirements of AS 3959 with the following variations:</p> <ul style="list-style-type: none"> (a) Sheet roofs (metal or fibre-cement sheet) must be fully sarked with a <i>sarking-type material</i> having a <i>Flammability Index</i> of not more than 5. (b) Joining strips in eaves lining, fascias and gables must be of bushfire-resisting timber. (c) Fibre-reinforced cement or aluminium must not be used for roof sheeting or fascias. (d) Aluminium must not be used for eaves lining.
<p>6. BAL — FZ</p>
<p>Roofs must comply with clauses 9.6.1, 9.6.2, 9.6.3 and 9.6.4 of the BAL — FZ requirements of AS 3959 with the following variation:</p> <ul style="list-style-type: none"> (a) Joining strips in eaves linings, fascias and gables must be of bushfire-resisting timber.
<p>ROOF LIGHTS (including vented roof lights and skylights)</p>
<p>1. BAL — Low</p>
<p>No requirements.</p>
<p>2. BAL — 12.5</p>
<p>Roof lights must comply with clause 5.6.5 of the BAL — 12.5 requirements of AS 3959 with the following variations:</p> <ul style="list-style-type: none"> (a) Aluminium mesh or perforated sheet must not be used for screening purposes. (b) Roof lights and associated shafts through the roof space must be sealed with a <i>non-combustible</i> sleeve or lining.
<p>3. BAL — 19</p>
<p>Roof lights must comply with clause 6.6.5 of the BAL — 19 requirements of AS 3959 with the following variations:</p> <ul style="list-style-type: none"> (a) Aluminium mesh or perforated sheet must not be used for screening purposes. (b) Roof lights and associated shafts through the roof space must be sealed with a <i>non-combustible</i> sleeve or lining.
<p>4. BAL — 29</p>
<p>Roof lights must comply with clause 7.6.5 of the BAL — 29 requirements of AS 3959 with the following variations:</p> <ul style="list-style-type: none"> (a) Aluminium mesh or perforated sheet must not be used for screening purposes. (b) Roof lights and associated shafts through the roof space must be sealed with a <i>non-combustible</i> sleeve or lining.
<p>5. BAL — 40</p>
<p>Roof lights must comply with clause 8.6.5 of the BAL — 40 requirements of AS 3959 with the following variation:</p>

FIRE SAFETY

Table SA 3.7.4.1 CONSTRUCTION REQUIREMENTS FOR BAL – LOW, BAL – 12.5, BAL – 19, BAL – 29, BAL – 40 and BAL – FZ SITES — continued

(a)	Roof lights and associated shafts through the roof space must be sealed with a <i>non-combustible</i> sleeve or lining.
6.	BAL — FZ
Roof lights must comply with clause 9.6.3 of the BAL — FZ requirements of AS 3959.	
ROOF-MOUNTED EVAPORATIVE COOLING UNITS	
1.	BAL — Low
No requirements.	
2.	BAL — 12.5
Evaporative coolers must comply with clause 5.6.5 of the BAL — 12.5 requirements of AS 3959 with the following variation:	
(a)	Aluminium mesh or aluminium perforated sheet must not be used for screening purposes.
3.	BAL — 19
Evaporative coolers must comply with clause 6.6.5 of the BAL — 19 requirements of AS 3959 with the following variation:	
(a)	Aluminium mesh or aluminium perforated sheet must not be used for screening purposes.
4.	BAL — 29
Evaporative coolers must comply with clause 7.6.5 of the BAL — 29 requirements of AS 3959 with the following variation:	
(a)	Aluminium mesh or aluminium perforated sheet must not be used for screening purposes.
5.	BAL — 40
Evaporative coolers must not be installed where the <i>site</i> has been classified as BAL — 40.	
6.	BAL — FZ
Evaporative coolers must not be installed where the <i>site</i> has been classified as BAL — FZ.	
OTHER ROOF PENETRATIONS	
(including roof ventilators, aerials, vent pipes and supports for solar collectors)	
1.	BAL — Low
No requirements.	
2.	BAL — 12.5
Roof penetrations must comply with clause 5.6.5 of the BAL — 12.5 requirements of AS 3959 with the following variations:	
(a)	Aluminium mesh or aluminium perforated sheet must not be used for screening purposes.
(b)	All components of roof ventilators (including rotary ventilators), aerials, vent pipes and supports for solar collectors must be of <i>non-combustible</i> material.
3.	BAL — 19

FIRE SAFETY

Table SA 3.7.4.1 CONSTRUCTION REQUIREMENTS FOR BAL – LOW, BAL – 12.5, BAL – 19, BAL – 29, BAL – 40 and BAL – FZ SITES — continued

Roof penetrations must comply with clause 6.6.5 of the BAL — 19 requirements of AS 3959 with the following variations:	
(a)	Aluminium mesh or aluminium perforated sheet must not be used for screening purposes.
(b)	All components of roof ventilators (including rotary ventilators), aerials, vent pipes and supports for solar collectors must be of <i>non-combustible</i> material.
4. BAL — 29	
Roof penetrations must comply with clause 7.6.5 of the BAL — 29 requirements of AS 3959 with the following variations:	
(a)	Aluminium mesh or aluminium perforated sheet must not be used for screening purposes.
(b)	All components of roof ventilators (including rotary ventilators), aerials, vent pipes and supports for solar collectors must be of <i>non-combustible</i> material.
5. BAL — 40	
Roof penetrations must comply with clause 8.6.5 of the BAL — 40 requirements of AS 3959 with the following variation:	
(a)	All components of roof ventilators (including rotary ventilators), aerials, vent pipes and supports for solar collectors must be of <i>non-combustible</i> material.
6. BAL — FZ	
Roof penetrations must comply with clause 9.6.3 of the BAL — FZ requirements of AS 3959 with the following variation:	
(a)	All components of aerials, vent pipes and supports for solar collectors must be of <i>non-combustible</i> material.
GUTTERS AND DOWNPIPES	
1. BAL — Low	
No requirements.	
2. BAL — 12.5	
Gutters and downpipes must comply with clause 5.6.7 of the BAL — 12.5 requirements of AS 3959.	
3. BAL — 19	
Gutters and downpipes must comply with clause 6.6.7 of the BAL — 19 requirements of AS 3959.	
4. BAL — 29	
Gutters and downpipes must comply with clause 7.6.7 of the BAL — 29 requirements of AS 3959.	
5. BAL — 40	
Gutters and downpipes must comply with clause 8.6.7 of the BAL — 40 requirements of AS 3959.	
6. BAL — FZ	

FIRE SAFETY

Table SA 3.7.4.1 CONSTRUCTION REQUIREMENTS FOR BAL – LOW, BAL – 12.5, BAL – 19, BAL – 29, BAL – 40 and BAL – FZ SITES — continued

Gutters and downpipes must comply with clause 9.6.5 of the BAL — FZ requirements of AS 3959.	
WATER AND GAS SUPPLY PIPES	
1. BAL — Low	No requirements.
2. BAL — 12.5	Water and gas supply pipes must comply with clause 5.8 of the BAL — 12.5 requirements of AS 3959.
3. BAL — 19	Water and gas supply pipes must comply with clause 6.8 of the BAL — 19 requirements of AS 3959.
4. BAL — 29	Water and gas supply pipes must comply with clause 7.8 of the BAL — 29 requirements of AS 3959.
5. BAL — 40	Water and gas supply pipes must comply with clause 8.8 of the BAL — 40 requirements of AS 3959.
6. BAL — FZ	Water and gas supply pipes must comply with clause 9.8 of the BAL — FZ requirements of AS 3959.
VERANDAHS, DECKS, STEPS, RAMPS AND LANDINGS (including balustrades, handrails or other barriers)	
1. BAL — Low	VerandaHS, decks, steps and trafficable surfaces of ramps and landings must comply with one or a combination of the following: <ul style="list-style-type: none"> (a) A concrete slab-on-ground. (b) A suspended concrete slab. (c) Any supporting posts or columns must comply with the BAL — Low requirements of this table for supporting posts, columns, stumps, piers and poles. (d) Any supporting walls must comply with the BAL — 12.5 requirements of this table for <i>external walls</i>. (e) Where sheeted or tongued and grooved solid flooring is used, the flooring system must comply with the BAL — Low requirements of this table for flooring systems. (f) Where a timber deck is used— <ul style="list-style-type: none"> (i) the gap between the timber decking must not be less than 5 mm; and (ii) to facilitate access for extinguishment, the perimeter of the deck must not be enclosed or access to the space beneath the deck impeded; and

FIRE SAFETY

Table SA 3.7.4.1 CONSTRUCTION REQUIREMENTS FOR BAL – LOW, BAL – 12.5, BAL – 19, BAL – 29, BAL – 40 and BAL – FZ SITES — continued

(iii)	the timber decking and flooring must be separated from the remainder of the building in a manner that will not spread the fire into the building.
2. BAL — 12.5	
Verandahs, decks, steps and trafficable surfaces of ramps and landings must comply with the BAL — Low requirements of this table with the following variations:	
(a)	Any supporting posts or columns must comply with the BAL — 12.5 requirements of this table for supporting posts, column stumps, piers and poles.
(b)	Where sheeted or tongued and grooved solid flooring is used, the flooring system must comply with the BAL — 12.5 requirements of this table for flooring systems.
3. BAL — 19	
Verandahs, decks, steps and trafficable surfaces of ramps and landings must comply with the BAL — Low requirements of this table with the following variations:	
(a)	Any supporting posts or columns must comply with the BAL — 19 requirements of this table for supporting posts, column stumps, piers and poles.
(b)	Any supporting walls must comply with the BAL — 19 requirements of this table for <i>external walls</i> .
(c)	Where sheeted or tongued and grooved solid flooring is used, the flooring system must comply with the BAL — 19 requirements of this table for flooring systems.
(d)	Where spaced timber deck flooring is used, bushfire-resisting timber must be used for the decking material.
4. BAL — 29	
Verandahs, decks, steps and trafficable surfaces of ramps and landings must comply with the BAL — Low requirements of this table with the following variations:	
(a)	Any supporting posts or columns must comply with the BAL — 29 requirements of this table for supporting posts, column stumps, piers and poles.
(b)	Any supporting walls must comply with the BAL — 29 requirements of this table for <i>external walls</i> .
(c)	Where sheeted or tongued and grooved solid flooring is used, the flooring system must comply with the BAL — 29 requirements of this table for flooring systems.
(d)	Where spaced timber deck flooring is used, bushfire-resisting timber must be used for the decking material.
(e)	Balustrades and handrails must be <i>non-combustible</i> , or if timber is used, it must be bushfire-resisting timber.
5. BAL — 40	
Verandahs, decks, steps and trafficable surfaces of ramps and landings must comply with the BAL — 40 requirements of AS 3959 with the following variation:	
(a)	Balustrades and handrails must be <i>non-combustible</i> .
6. BAL — FZ	
Verandahs, decks, steps and trafficable surfaces of ramps and landings must comply with BAL — FZ requirements of AS 3959 with the following variation:	

FIRE SAFETY

Table SA 3.7.4.1 CONSTRUCTION REQUIREMENTS FOR BAL – LOW, BAL – 12.5, BAL – 19, BAL – 29, BAL – 40 and BAL – FZ SITES — continued

- (a) Balustrades and handrails must be *non-combustible*.

In Tasmania insert Tas 3.7.4.1 and Tas 3.7.4.2 as follows:

Tas 3.7.4.1 Vehicular access

- (a) A Class 1 building in a *designated bushfire prone area* and the fire fighting water supply access point must be accessible by a private access road which is designed, constructed and maintained to a standard not less than a Modified 4C Access Road.
- (b) **A Modified 4C Access Road** is an all weather road which complies with the Australian Road Research Board "Unsealed Roads Manual – Guidelines to Good Practice", 3rd Edition, March 2009 as a classification 4C Access Road and the following modified requirements:
- Single lane private access roads less than 6 m carriageway width must have 20 m long passing bays of 6 m carriageway width not more than 100 m apart.
 - A private access road longer than 100 m must be provided with a driveway encircling the building, or a hammerhead "T" or "Y" turning head 4 m wide and 8 m long, or a trafficable circular turning area of 10 m radius.
 - Culverts and bridges must be designed for a minimum vehicle load of 20 tonnes.
 - Vegetation must be cleared for a height of 4 m, above the carriageway, and 2 m each side of the carriageway.

Tas 3.7.4.2 Water Supply

- (a) The exterior elements of a Class 1 building in a *designated bushfire prone area* must be within reach of a 120 m long hose connected to—
- a fire hydrant; or
 - a stored water supply in a water tank, *swimming pool*, dam or lake available for fire fighting at all times which has a capacity of at least 10,000 L for each separate building.
- (b) A water tank and above ground pipes and fittings used for a stored water supply must be made of non-rusting, *non-combustible*, non-heat-deforming materials and must be situated more than 6 m from a building.
- (c) The water tank must have an opening in the top of not less than 250 mm diameter or be fitted with a DIN or NEN standard forged Storz 65 mm adaptor fitted with a suction washer.

PART 3.7.5 ALPINE AREAS

Appropriate *Performance Requirements*:

Where an alternative *alpine area* egress design is proposed as an *Alternative Solution* to that described in **Part 3.7.5**, that proposal must comply with—

- (a) *Performance Requirement P2.3.6*; and
- (b) the relevant *Performance Requirements* determined in accordance with **1.0.10**.

Acceptable construction practice

3.7.5.1 Application

Compliance with this acceptable construction practice for buildings which are located in *alpine areas* (see **Figure 3.7.5.2**) satisfies *Performance Requirement P2.3.6*.

3.7.5.2 External doorways

An external door in a building constructed in an *alpine area*, which may be subject to a build-up of snow must—

- (a) open inwards; and
- (b) be marked “OPEN INWARDS” on the inside face of the door in letters not less than 75 mm high and in a colour contrasting with that of the background; and
- (c) if it serves a corridor or stairway, be positioned in an alcove or recess with—
 - (A) no horizontal dimension of the alcove or recess less than twice the width of the door; and
 - (B) the door positioned to open against a wall such that the distance from any part of its swing to the nearest point of entry of the stairway or corridor is not less than the width of the door.

3.7.5.3 External ramps

An external ramp serving an external doorway must have a gradient not steeper than 1:12.

3.7.5.4 Discharge of external doorways providing a means of egress

A building in an *alpine area* must be constructed so that—

- (a) for any *external walls* more than 3.6 m above the natural ground level, the distance of that part of the building from the allotment boundary (other than a road alignment) must be not less than 2.5 m plus 100 mm for each 300 mm or part by which that part of the *external wall* exceeds a height of 3.6 m; and

FIRE SAFETY

- (b) an external doorway may discharge into a court between wings of a building provided the wings are at least 6 m apart; and
- (c) where an external doorway discharges opposite a barrier or embankment which is more than 900 mm above the threshold of that doorway, the distance between the threshold and the barrier is not less than twice the height of the barrier or 6 m, whichever is the lesser (see [Figure 3.7.5.3](#)).

3.7.5.5 External trafficable structures

External stairways, ramps, access bridges or other trafficable structures serving the building must have—

- (a) a floor surface that consists of steel mesh or other suitable material if it is used as a means of egress; and
- (b) any *required* barrier constructed so that its sides are not less than 75% open.

Figure 3.7.5.1

DESIGN FOR SAFE EGRESS IN ALPINE AREAS — MINIMUM DIMENSIONS OF ALCOVE OR RECESS AT EXTERNAL DOORWAY

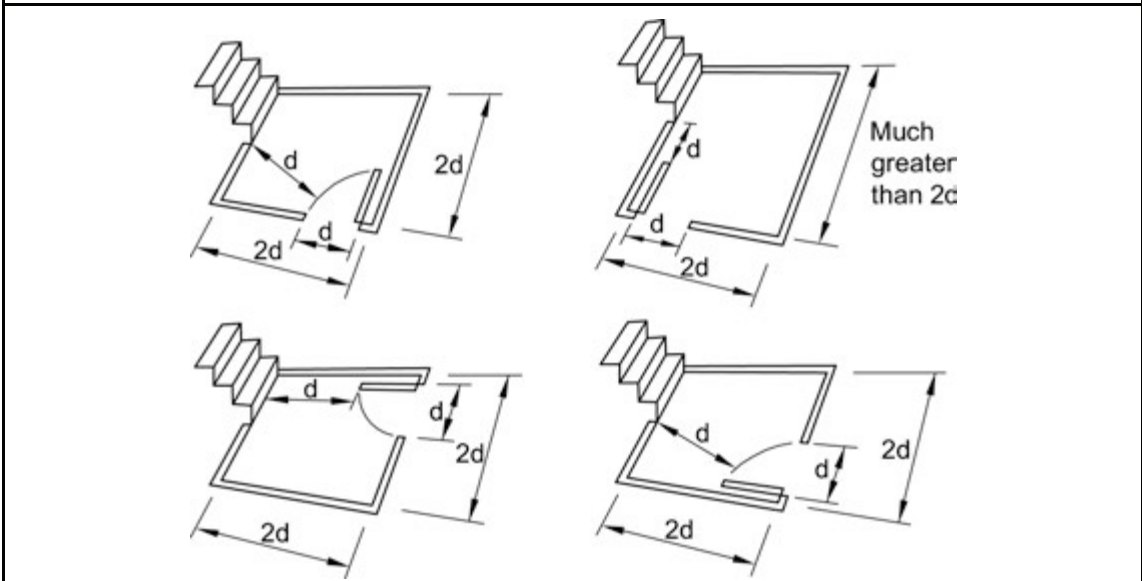

FIRE SAFETY

Figure 3.7.5.2
ALPINE AREAS

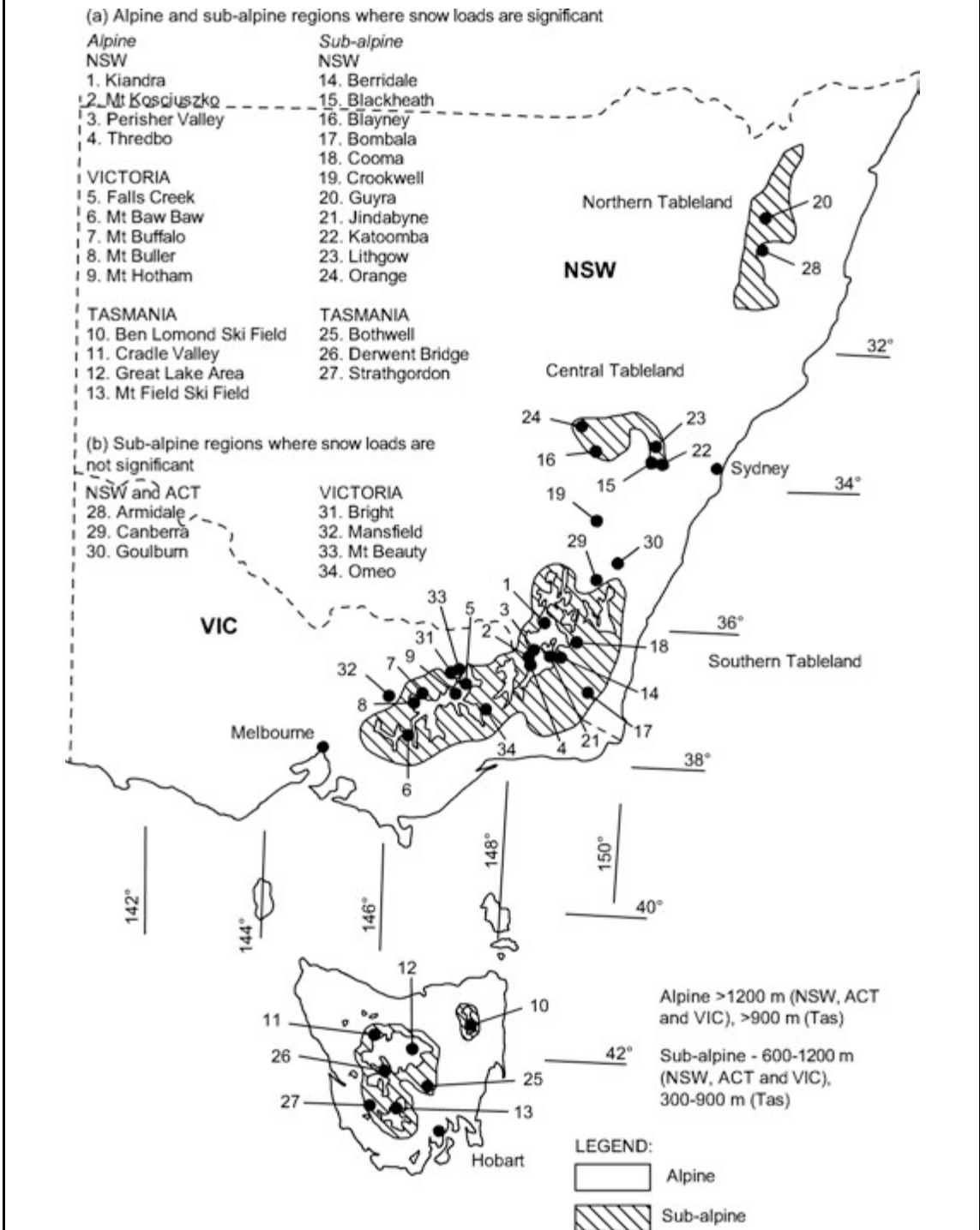

FIRE SAFETY

Explanatory information:

Alpine and sub-*alpine areas* are located in ACT, NSW, Victoria and Tasmania.

Alpine areas are areas 1200 m or more above Australian Height Datum (AHD) for NSW, ACT and Victoria, and 900 m or more above AHD for Tasmania, as shown in [Figure 3.7.5.2](#).

Significant snowfalls (snowfalls which result in an average snow accumulation on the ground of 175 mm or greater) may occur in the sub-*alpine areas* shown in [Figure 3.7.5.2](#). [Part 3.7.5](#) does not apply to those areas because, unlike *alpine areas*, successive snowfalls are not likely to accumulate.

It is noted that in the ACT, the Canberra area is designated as a sub-alpine region where snow loads are not considered significant.

Figure 3.7.5.3

DESIGN FOR SAFE EGRESS IN ALPINE AREAS — DISCHARGE OF EXTERNAL DOORWAY

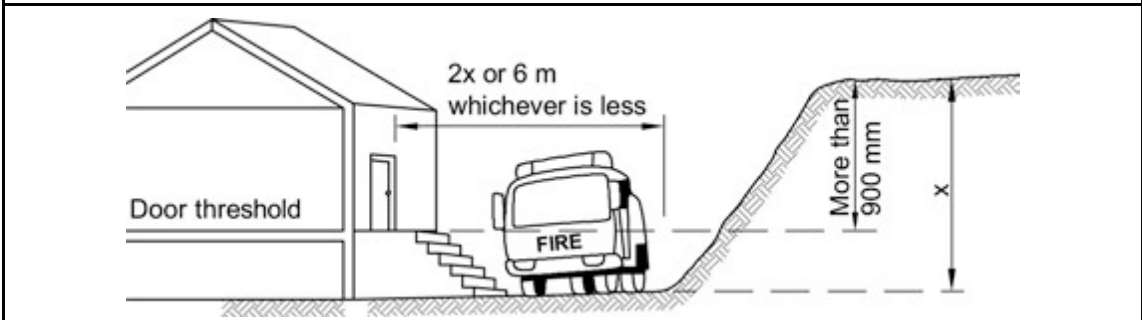

PART **3.8**

HEALTH AND AMENITY

- 3.8.1 Wet Areas and external waterproofing**
- 3.8.2 Room Heights**
- 3.8.3 Facilities**
- 3.8.4 Light**
- 3.8.5 Ventilation**
- 3.8.6 Sound Insulation**

PART 3.8 CONTENTS

PART 3.8 HEALTH AND AMENITY

3.8.1 Wet areas and external waterproofing

- 3.8.1 Definitions
- 3.8.1.1 Application
- 3.8.1.2 Wet areas

3.8.2 Room heights

- 3.8.2.1 Application
- 3.8.2.2 Ceiling heights

3.8.3 Facilities

- 3.8.3.1 Application
- 3.8.3.2 Required facilities
- 3.8.3.3 Construction of sanitary compartments

3.8.4 Light

- 3.8.4.1 Application
- 3.8.4.2 Natural lighting
- 3.8.4.3 Artificial lighting

3.8.5 Ventilation

- 3.8.5.0 Acceptable construction manual
- 3.8.5.1 Application
- 3.8.5.2 Ventilation requirements
- 3.8.5.3 Location of sanitary compartments

3.8.6 Sound insulation

- 3.8.6.1 Application
- 3.8.6.2 Sound insulation requirements
- 3.8.6.3 General installation requirements for walls
- 3.8.6.4 Services

PART 3.8.1 WET AREAS AND EXTERNAL WATERPROOFING

Appropriate *Performance Requirements*:

- (a) Where an alternative system for external *waterproofing* a roof or external wall of a building is proposed as an *Alternative Solution* to that described in **Part 3.8.1**, that proposal must comply with—
 - (i) *Performance Requirement P2.2.2*; and
 - (ii) the relevant *Performance Requirements* determined in accordance with **1.0.10**.
- (b) Where an alternative system for protecting *wet areas* in a building is proposed as an *Alternative Solution* to that described in **Part 3.8.1**, that proposal must comply with—
 - (i) *Performance Requirement P2.4.1*; and
 - (ii) the relevant *Performance Requirements* determined in accordance with **1.0.10**.

Definitions:

3.8.1 Definitions used in this Part are as follows:

Shower area means the area affected by water from a shower, including a shower over a bath.

Vessel means an open, pre-formed, pre-finished concave receptacle capable of holding water, usually for the purpose of washing, including a basin, sink, bath, laundry tub and the like.

Waterproof means the property of a material that does not allow moisture to penetrate through it.

Water resistant means the property of a system or material that restricts moisture movement and will not degrade under conditions of moisture.

Wet area means an area within a building supplied with water from a water supply system, which includes bathrooms, showers, laundries and sanitary compartments and excludes kitchens, bar areas, kitchenettes or domestic food and beverage preparation areas.

Acceptable construction practice

3.8.1.1 Application

Compliance with this acceptable construction practice satisfies *Performance Requirements P2.2.2* for external *waterproofing* and *P2.4.1* for *wet areas*.

3.8.1.2 Wet Areas

Building elements in *wet areas* within a building must—

- (a) be *waterproof* or *water resistant* in accordance with [Table 3.8.1.1](#); and
- (b) comply with AS 3740.

Table 3.8.1.1 WATERPROOFING AND WATER RESISTANCE REQUIREMENTS FOR BUILDING ELEMENTS IN WET AREAS

<i>Vessels</i> or area where the fixture is installed	Floors and horizontal surfaces	Walls	Wall junctions and joints	Wall / floor junctions	Penetrations
Shower area (enclosed and unenclosed)					
With hob	<i>Waterproof</i> floor in <i>shower area</i> (including any hob or step-down).	(a) <i>Waterproof</i> all walls in <i>shower area</i> to a height the greater of—	<i>Waterproof</i> wall junctions within <i>shower area</i> .	<i>Waterproof</i> wall / floor junctions within <i>shower area</i> .	<i>Waterproof</i> penetrations in <i>shower area</i> .
With step-down		(i) not less than 150 mm above floor substrate; or			
Without hob or step-down		(ii) not less than 25 mm above maximum retained water level; and			
With preformed shower base	N/A	(b) <i>Water resistant</i> walls in <i>shower area</i> to not less than 1800 mm above finished floor level of the shower.	<i>Waterproof</i> wall junctions within <i>shower area</i> .	<i>Waterproof</i> wall / floor junctions within <i>shower area</i> .	<i>Waterproof</i> penetrations in <i>shower area</i> .

Table 3.8.1.1 WATERPROOFING AND WATER RESISTANCE REQUIREMENTS FOR BUILDING ELEMENTS IN WET AREAS— continued

Vessels or area where the fixture is installed	Floors and horizontal surfaces	Walls	Wall junctions and joints	Wall / floor junctions	Penetrations
Area outside shower area					
For concrete and compressed fibre-cement sheet flooring	<i>Water resistant</i> floor of the room.	N/A	N/A	<i>Waterproof</i> wall / floor junctions	N/A
For timber floors including particleboard, plywood and other timber based flooring materials	<i>Waterproof</i> floor of the room.				
Areas adjacent to baths and spas					
For concrete and compressed fibre-cement sheet flooring	<i>Water resistant</i> floor of the room.	(a) <i>Water resistant</i> to a height of not less than 150 mm above the <i>vessel</i> , for the extent of the <i>vessel</i> , where the <i>vessel</i> is within 75 mm of a wall.	<i>Water resistant</i> junctions within 150 mm above a <i>vessel</i> for the extent of the <i>vessel</i> .	<i>Water resistant</i> wall / floor junctions for the extent of the <i>vessel</i> .	<i>Waterproof</i> tap and spout penetrations where they occur in horizontal surfaces.
For timber floors including particleboard, plywood and other timber based flooring materials	<i>Waterproof</i> floor of the room.	(b) <i>Water resistant</i> all exposed surfaces below <i>vessel</i> lip.			

Table 3.8.1.1 WATERPROOFING AND WATER RESISTANCE REQUIREMENTS FOR BUILDING ELEMENTS IN WET AREAS— continued

Vessels or area where the fixture is installed	Floors and horizontal surfaces	Walls	Wall junctions and joints	Wall / floor junctions	Penetrations
Inserted baths and spas	(a) <i>Waterproof</i> shelf area, incorporating waterstop under the bath lip. (b) No requirement under bath.	(a) <i>Waterproof</i> to not less than 150 mm above lip of bath or spa; and (b) No requirement under bath.	(a) <i>Waterproof</i> junctions within 150 mm above bath or spa; and (b) No requirement under bath.	N/A	<i>Waterproof</i> tap and spout penetrations where they occur in horizontal surfaces.
Note: Where a shower is above a bath or spa, use requirements for shower.					
Other areas					
Laundries and WCs	<i>Water resistant</i> floor of the room.	N/A	N/A	<i>Waterproof</i> wall / floor junctions.	
Walls adjoining other <i>vessels</i> (e.g. sink, basin or laundry tub)	N/A	<i>Water resistant</i> to a height of not less than 150 mm above the <i>vessel</i> , for the extent of the <i>vessel</i> , where the <i>vessel</i> is within 75 mm of a wall.	<i>Waterproof</i> wall junctions where a <i>vessel</i> is fixed to a wall.	N/A	<i>Waterproof</i> tap and spout penetrations where they occur in surfaces <i>required</i> to be <i>waterproof</i> or <i>water resistant</i> .
Note: N/A means not applicable.					

HEALTH AND AMENITY

STATE AND TERRITORY VARIATIONS

In South Australia delete 3.8.1.2 and insert SA 3.8.1.2 as follows:

Building elements in *wet areas* within a building must—

- (a) be *waterproof* or *water resistant* in accordance with **Table 3.8.1.1**, except that—
- (i) in any room containing a washing machine, the wall area from finished floor level to a minimum of 75 mm above and 75 mm each side of the washing machine tap outlets must be *water resistant*; and
 - (ii) where a *vessel* is inset into a bench top in a kitchen, bar area, kitchenette or domestic food and beverage preparation area—
 - (A) wall junctions and joints within 150 mm above the *vessel* must be *water resistant* for the extent of the *vessel*; and
 - (B) the perimeter edges of the *vessel* must be *water resistant* for the extent of the *vessel* (see **Figure SA 3.8.1.2**); and
 - (iii) penetrations in horizontal surfaces for tap and spout outlets in kitchens, bar areas, kitchenettes or domestic food and beverage preparation areas, must be *waterproof*; and
- (b) comply with AS 3740; and
- (c) have floor wastes provided in accordance with **SA 3.2.2**.

Figure SA 3.8.1.2

TYPICAL WATER RESISTANT JUNCTIONS AND JOINTS FOR BENCH TOPS WITH INSET VESSELS AND VESSELS ABUTTING WALLS

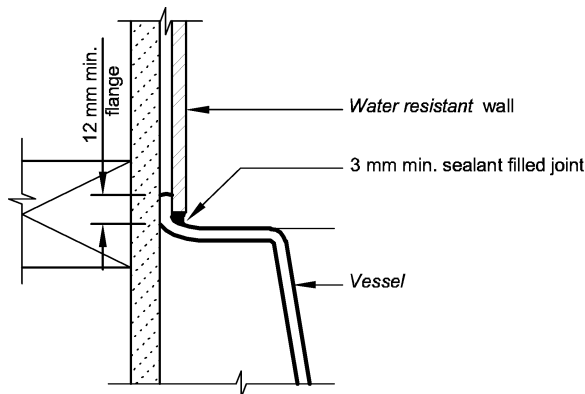

HEALTH AND AMENITY

Figure SA 3.8.1.2

TYPICAL WATER RESISTANT JUNCTIONS AND JOINTS FOR BENCH TOPS WITH INSET VESSELS AND VESSELS ABUTTING WALLS

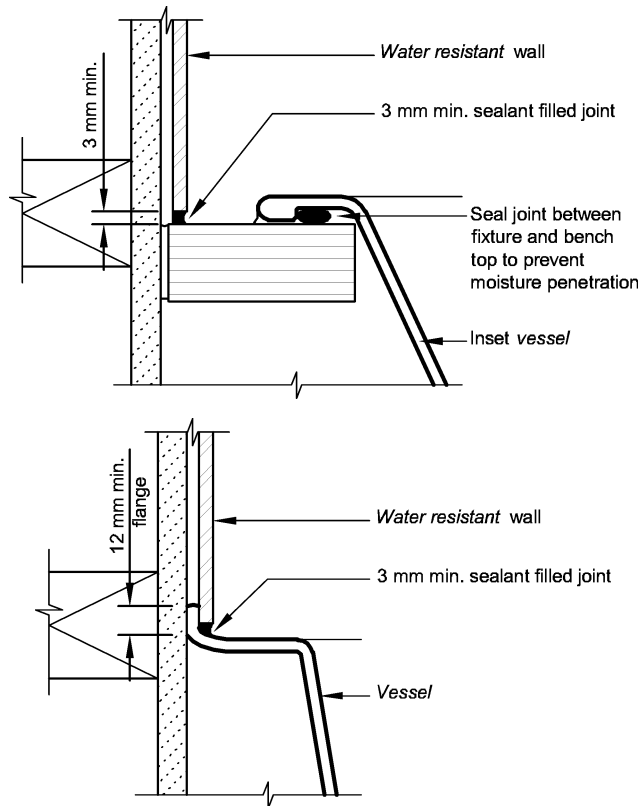

3.8.1.3 External above ground membranes

Waterproofing membranes for external above ground use must comply with AS 4654 Parts 1 and 2.

PART 3.8.2 ROOM HEIGHTS

Appropriate *Performance Requirements*:

Where an alternative ceiling height is proposed as an *Alternative Solution* to that described in **Part 3.8.2**, that proposal must comply with—

- (a) *Performance Requirement P2.4.2*; and
- (b) the relevant *Performance Requirements* determined in accordance with **1.0.10**.

Acceptable construction practice

3.8.2.1 Application

Compliance with this acceptable construction practice satisfies *Performance Requirement P2.4.2* for room heights.

3.8.2.2 Ceiling heights

Ceiling heights (see **Figure 3.8.2.1**) must be not less than—

- (a) in a *habitable room* excluding a kitchen — 2.4 m; and
- (b) in a kitchen — 2.1 m; and
- (c) in a corridor, passageway or the like — 2.1 m; and
- (d) in a bathroom, shower room, laundry, *sanitary compartment*, airlock, pantry, storeroom, garage, car parking area or the like — 2.1 m; and
- (e) in a room or space with a sloping ceiling or projections below the ceiling line within—
 - (i) a *habitable room*—
 - (A) in an attic — a height of not less than 2.2 m for at least two-thirds of the floor area of the room or space; and
 - (B) in other rooms — a height of not less than 2.4 m over two-thirds of the floor area of the room or space; and
 - (ii) a non-*habitable room* — a height of not less than 2.1 m for at least two-thirds of the floor area of the room or space,and when calculating the floor area of a room or space, any part that has a ceiling height of less than 1.5 m is not included; and
- (f) in a stairway, ramp, *landing*, or the like — 2.0 m measured vertically above the nosing line of stairway treads or the floor surface of a ramp, *landing* or the like.

HEALTH AND AMENITY

Figure 3.8.2.1

MEASUREMENT OF ACCEPTABLE CEILING HEIGHTS

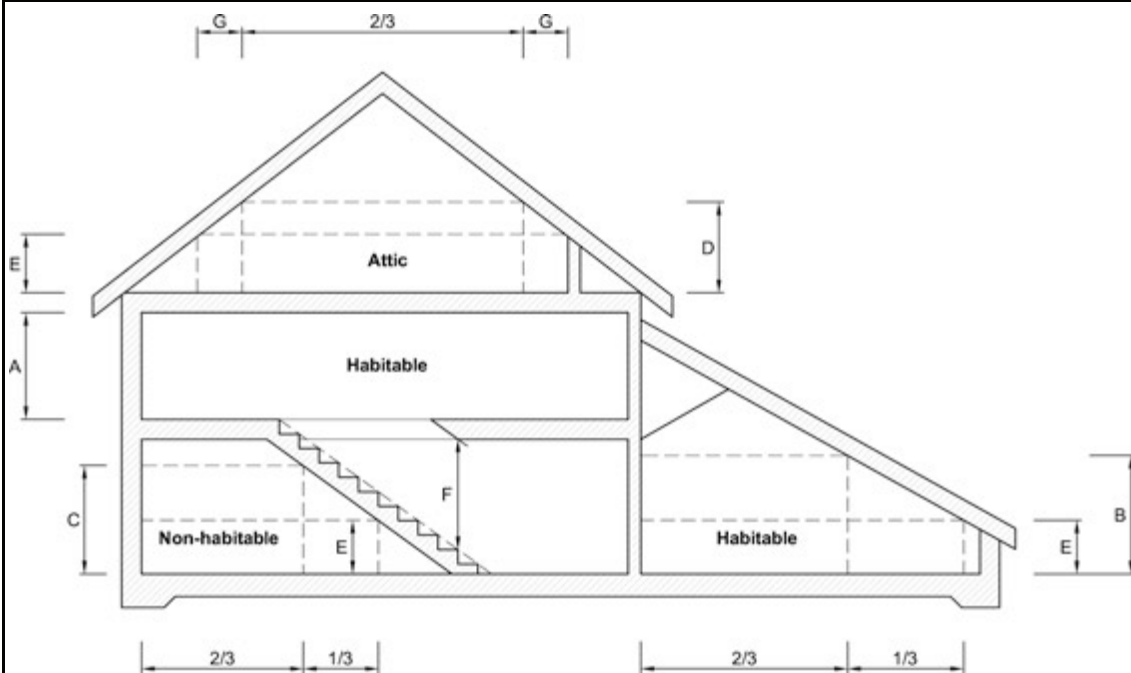

Note: The letters in the diagram represent the following minimum dimensions:

- A = 2.4 m In a *habitable room* (excluding a kitchen).
- B = 2.4 m In a *habitable room* with a sloping ceiling for at least two-thirds of the floor area of the room or space.
- C = 2.1 m In a *non-habitable room* with a sloping ceiling for at least two-thirds of the floor area of the room or space.
- D = 2.2 m In an attic with a sloping ceiling for at least two-thirds of the floor area of the room or space.
- E = 1.5 m For the purpose of calculating the floor area of a room or space, any ceiling height of less than 1.5 m is excluded.
- F = 2.0 m In a stairway (measured vertically above the nosing line).

The combined dimensions of G must not exceed one-third of the floor area (See E above) of the room or space.

PART 3.8.3 FACILITIES

Appropriate *Performance Requirements*:

Where an alternative arrangement for facilities is proposed as an *Alternative Solution* to that described in **Part 3.8.3**, that proposal must comply with—

- (a) *Performance Requirement P2.4.3*; and
- (b) the relevant *Performance Requirements* determined in accordance with **1.0.10**.

Acceptable construction practice

3.8.3.1 Application

Compliance with this acceptable construction practice satisfies *Performance Requirement P2.4.3* for facilities.

Explanatory information:

Additional requirements relating to facilities for people with a disability in Class 1b and Class 10a buildings are contained in Volume One of the BCA. These requirements are based on the Disability (Access to Premises – Buildings) Standards which are available from the Australian Government Attorney-General's Department website at www.ag.gov.au.

3.8.3.2 Required facilities

- (a) A Class 1 building must be provided with—
 - (i) a kitchen sink and facilities for the preparation and cooking of food; and
 - (ii) a bath or shower; and
 - (iii) clothes washing facilities, comprising at least one washtub and space in the same room for a washing machine; and
 - (iv) a closet pan and washbasin.
- (b) If any of the facilities in (a) are detached from the main building, they must be set aside for the exclusive use of the occupants of the building.

Explanatory information:

A kitchen sink or washbasin must not be counted as a laundry washtub. However, a laundry washtub is considered to provide the necessary means to dispose of waste water as *required* by **P2.4.3**.

3.8.3.3 Construction of sanitary compartments

The door to a fully enclosed *sanitary compartment* must—

HEALTH AND AMENITY

- (a) open outwards; or
- (b) slide; or
- (c) be readily removable from the outside of the compartment,

unless there is a clear space of at least 1.2 m, measured in accordance with **Figure 3.8.3.3**, between the closet pan within the *sanitary compartment* and the doorway.

Figure 3.8.3.3

CONSTRUCTION OF SANITARY COMPARTMENTS

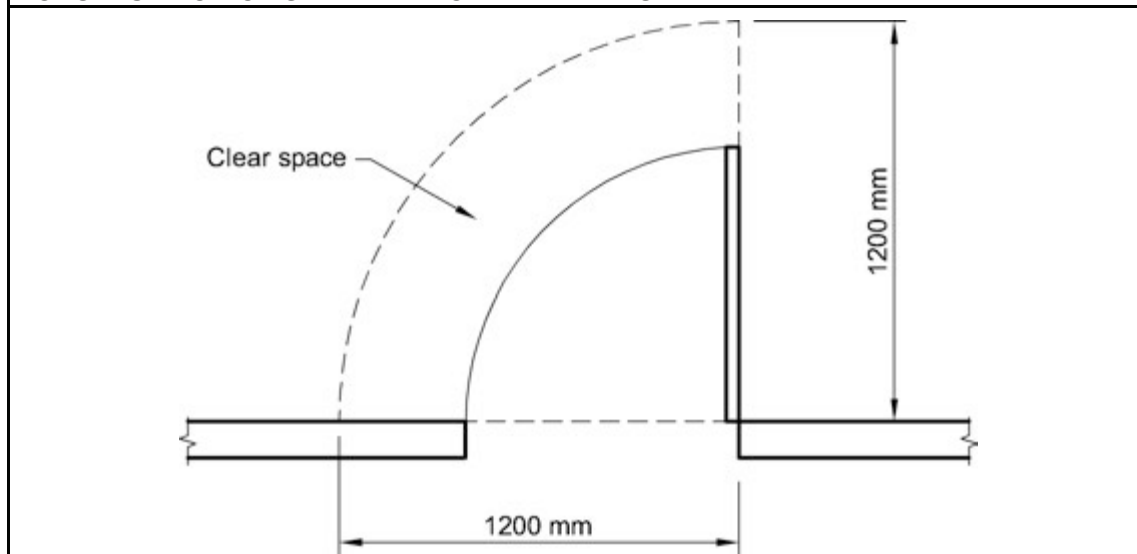

Explanatory information:

3.8.3.3 requires means of removing an unconscious occupant from a fully enclosed *sanitary compartment*. If the enclosure has gaps that are large enough to allow access for a person into the *sanitary compartment*, the compartment is not considered enclosed for the purpose of this clause.

STATE AND TERRITORY VARIATIONS

Part 3.8.3.4 is added as follows in Tasmania.

Installation of closet fixtures

- (a) If a sufficient sewerage system is not available, an authorised alternative means of disposal of sewage may be installed.
- (b) If sanitary facilities are not water-flushed, the following provisions apply.
 - (i) A pit latrine, an incinerating toilet, a chemical toilet, a removable pan or a non-flushing urinal must not be within 2 m of a building containing *habitable rooms*.
 - (ii) The floor on which a removable pan is placed must be impervious.
 - (iii) A room containing a composting toilet must be separated from *habitable rooms* by way of a permanently ventilated air lock (which may be a circulation space).
 - (iv) The minimum ventilation *required* under (iii) shall be the greater of—
 - (A) 8000 mm²; or

HEALTH AND AMENITY

- (B) 1/500th of the *floor area* of the circulation space.
- (v) Access for maintenance or removal of waste from a composting toilet must be by way of an access door which opens directly to the outside of the building.

PART 3.8.4 LIGHT

Appropriate *Performance Requirements*:

Where an alternative lighting system is proposed as an *Alternative Solution* to that described in **Part 3.8.4**, that proposal must comply with—

- (a) *Performance Requirement P2.4.4*; and
- (b) the relevant *Performance Requirements* determined in accordance with **1.0.10**.

Acceptable construction practice

3.8.4.1 Application

Compliance with this acceptable construction practice for a Class 1 building satisfies *Performance Requirement P2.4.4* for lighting.

3.8.4.2 Natural lighting

Natural lighting must be provided in a Class 1 building to all *habitable rooms*, in accordance with the following:

- (a) Natural lighting must be provided by—
 - (i) *windows*, excluding *roof lights* that—
 - (A) have an aggregate light transmitting area measured exclusive of framing members, glazing bars or other obstructions of not less than 10% of the *floor area* of the room; and
 - (B) are open to the sky or face a court or other space open to the sky or an open verandah, carport or the like; or
 - (ii) *roof lights* that—
 - (A) have an aggregate light transmitting area measured exclusive of framing members, glazing bars or other obstructions of not less than 3% of the *floor area* of the room; and
 - (B) are open to the sky; or
 - (iii) a proportional combination of *windows* and *roof lights required* by (i) and (ii).

HEALTH AND AMENITY

Explanatory information:

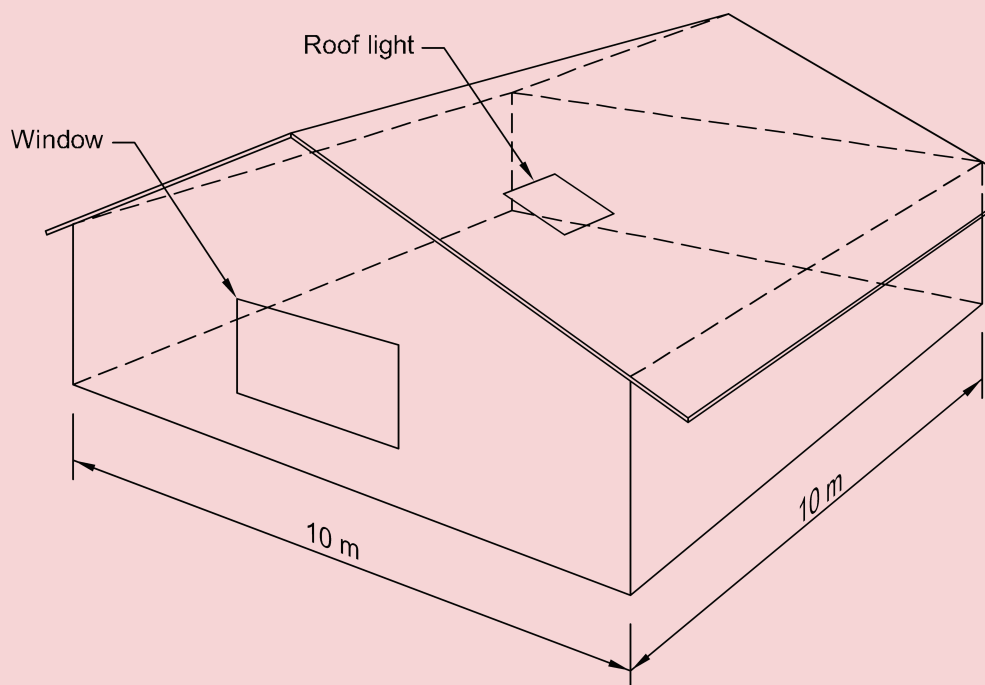
Method for determining proportional combination of *windows* and *roof lights*.

Description of above diagram

Area of the room which *requires* natural lighting is 100 m².

No natural light borrowed from adjoining rooms.

General requirements

Required windows to provide natural lighting must have a light transmitting area of at least 10% of the *floor area*.

$$10\% \text{ of } 100 \text{ m}^2 = 10 \text{ m}^2$$

Or, *roof lights* to provide natural lighting must have a light transmitting area of at least 3% of the *floor area*.

$$3\% \text{ of } 100 \text{ m}^2 = 3 \text{ m}^2$$

Calculations

Formula — for the area of *windows required* to compensate for *roof light short fall*

Area of room covered by the *roof light* = (Area of *roof light*) / 0.03

Required window area = [(*floor area*) – (Area covered by the *roof light*)] / 10

Area of *windows required* to compensate for *roof light short fall*

If the *roof light* = 1 m²

HEALTH AND AMENITY

Area of room covered by the <i>roof light</i>	= (1 m ² / 0.03)
	= 33.33 m ²
<i>Required window</i> area	= (100 m ² – 33.33 m ²) / 10
	= 6.67 m ²

Formula — for the area of *roof lights* required to compensate for *window* short fall

Area of room covered by the <i>window</i>	= (Area of <i>window</i>) / 0.1
---	----------------------------------

<i>Required roof light</i> area	= [(<i>Floor area</i>) – (Area covered by the <i>window</i>)] / 33.33
---------------------------------	--

Area of *roof lights* required to compensate for *window* short fall

If the *window* = 5 m²

Area of room covered by the <i>window</i>	= (5 m ² / 0.1)
---	----------------------------

$$= 50 \text{ m}^2$$

<i>Required roof lights</i> area	= (100 m ² – 50 m ²) / 33.33
	= 1.5 m ²

Notes:

- For the purpose of this table a *window* excludes a *roof light*.
- The same proportional calculation principle applies if—
 - two or more *windows* are used; or
 - two or more *roof lights* are used.

- A *window required* to provide natural light that faces a boundary of an adjoining allotment must not be less than a horizontal distance of 900 mm from that boundary.
- Natural lighting to a room in a Class 1 building may come through a glazed panel or opening from an adjoining room (including an enclosed verandah) if—
 - the glazed panel or opening has an area of not less than 10% of the *floor area* of the room to which it provides light; and
 - the adjoining room has—
 - windows*, excluding *roof lights* that—
 - have an aggregate light transmitting area of not less than 10% of the combined *floor area* of both rooms; and
 - are open to the sky or face a court or other space open to the sky or an open verandah, carport or the like; or
 - roof lights* that—
 - have an aggregate light transmitting area of not less than 3% of the combined *floor area* of both rooms; and

HEALTH AND AMENITY

- (bb) are open to the sky; or
- (C) a proportional combination of *windows* and *roof lights required* by (A) and (B).
- (iii) the areas specified in (i) and (ii) may be reduced as appropriate if direct natural light is provided from another source.
- (see [Figure 3.8.4.1](#))

Explanatory information:

Direct natural light provided from another source is intended to mean light from a *window* or *roof light* in the subject room. As the provision relates to natural lighting obtained from an adjoining room, 'another source' refers to direct natural light provided to the subject room which does not meet the *required* allowance of either 10% or 3% of the *floor area* of that room. By not meeting the *required* amount of natural light, the 'direct natural light from another source' can be used as a supplement to the natural light *required* from an adjoining room.

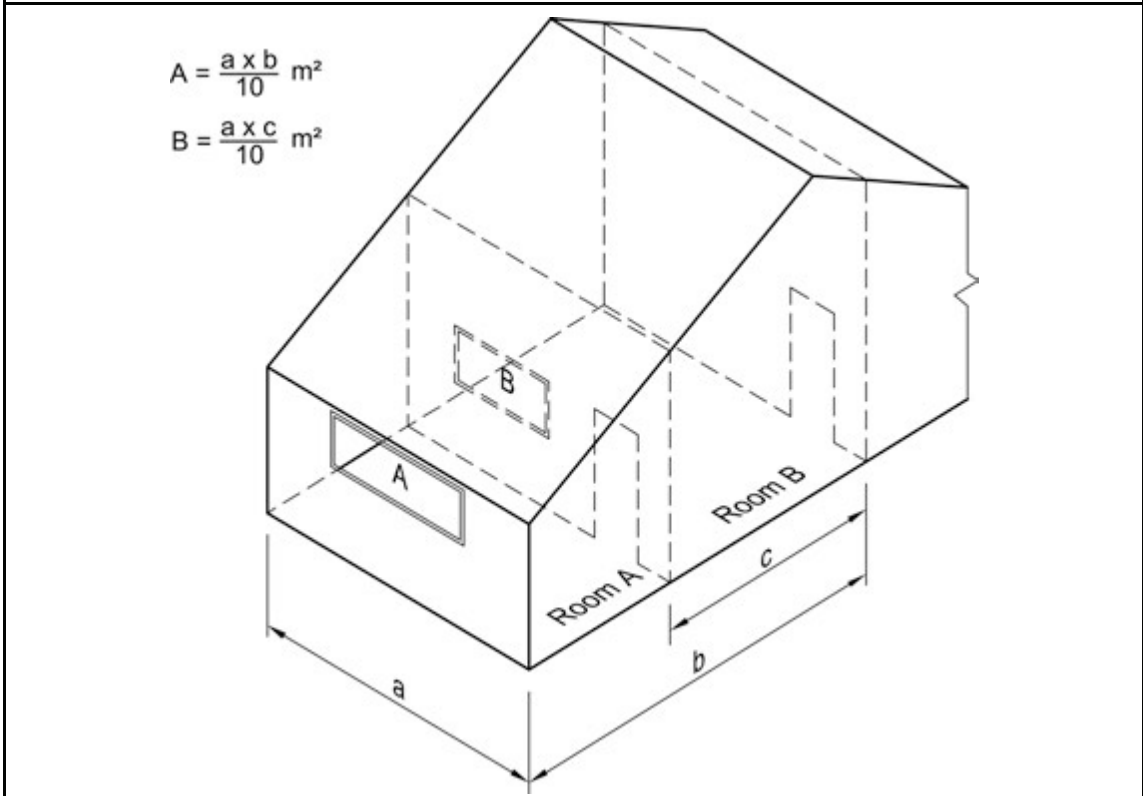
Figure 3.8.4.1**METHOD OF DETERMINING AREAS OF OPENINGS FOR BORROWED LIGHT****3.8.4.3 Artificial lighting**

Sanitary compartments, bathrooms, shower rooms, airlocks and laundries must be provided with artificial light if natural lighting in accordance with the relevant provisions of [3.8.4.2](#) is not available—

HEALTH AND AMENITY

- (a) at a rate of not less than one light fitting per 16 m² of *floor area*; or
- (b) in accordance with AS/NZS 1680.0.

PART 3.8.5 VENTILATION

Appropriate *Performance Requirements*:

Where an alternative ventilation system is proposed as an *Alternative Solution* to that described in **Part 3.8.5**, that proposal must comply with—

- (a) *Performance Requirement P2.4.5*; and
- (b) the relevant *Performance Requirements* determined in accordance with **1.0.10**.

Explanatory information:

The requirements of this Part are to be read in conjunction with the air movement requirements in **Part 3.12.4**. However, it should be noted that **Part 3.12.4** does not apply in all States and Territories.

Acceptable construction manual

3.8.5.0

- (a) Except for an exhaust fan from a *sanitary compartment*, laundry or bathroom, *Performance Requirement P2.4.5* is satisfied for a mechanical ventilation system if it is installed in accordance with AS 1668.2.
- (b) An exhaust fan from a *sanitary compartment*, laundry or bathroom must comply with the acceptable construction practice.

Acceptable construction practice

3.8.5.1 Application

Compliance with this acceptable construction practice satisfies *Performance Requirement P2.4.5* for ventilation.

3.8.5.2 Ventilation requirements

Ventilation must be provided to a *habitable room*, *sanitary compartment*, bathroom, shower room, laundry and any other room occupied by a person for any purpose by any of the following means:

- (a) Permanent openings, *windows*, doors or other devices which can be opened—
 - (i) with an aggregate opening or openable size not less than 5% of the *floor area* of the room *required* to be ventilated; and

HEALTH AND AMENITY

- (ii) open to—
- a suitably sized court, or space open to the sky; or
 - an open verandah, carport, or the like; or
 - an adjoining room in accordance with (b).
- (b) Natural ventilation to a room may come through a *window*, opening, ventilating door or other device from an adjoining room (including an enclosed verandah) if—
- the room to be ventilated or the adjoining room is not a *sanitary compartment*; and
 - the *window*, opening, door or other device has a ventilating area of not less than 5% of the *floor area* of the room to be ventilated; and
 - the adjoining room has a *window*, opening, door or other device with a ventilating area of not less than 5% of the combined *floor areas* of both rooms; and
 - the ventilating areas specified may be reduced as appropriate if direct natural ventilation is provided from another source.
- (See [Figure 3.8.5.1](#))

Figure 3.8.5.1

METHOD OF DETERMINING AREAS OF OPENINGS FOR BORROWED VENTILATION

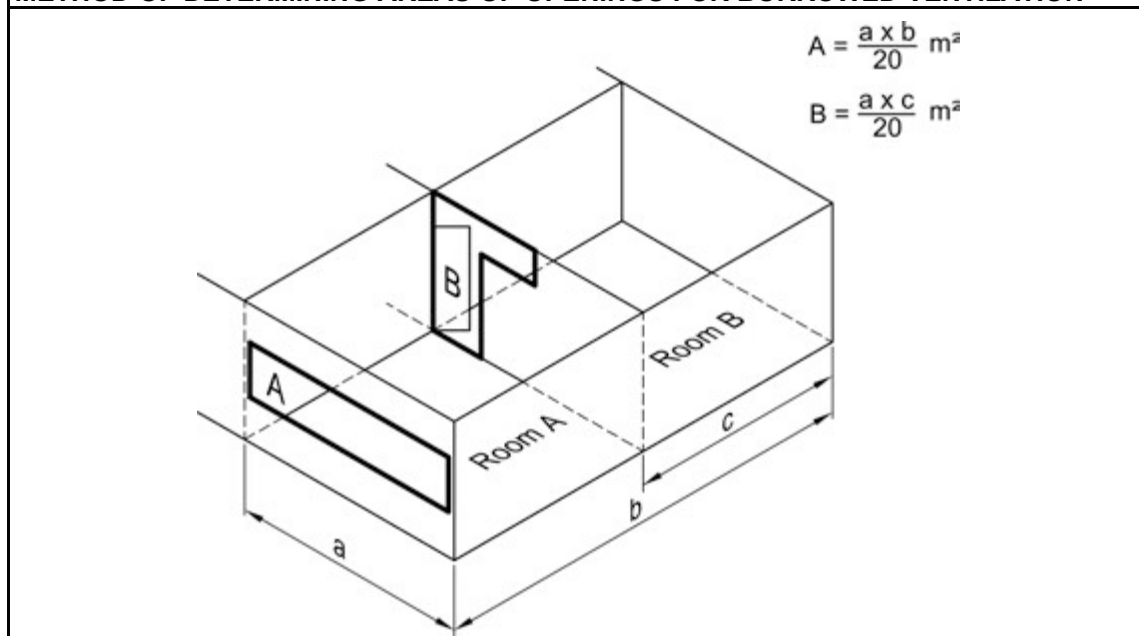

- (c) An exhaust fan or other means of mechanical ventilation may be used to ventilate a *sanitary compartment*, laundry or bathroom provided contaminated air exhausts—
- directly to outside the building by way of ducts; or
 - into a roof space that—
 - is adequately ventilated by open eaves, and/or roof vents; or
 - is covered by roof tiles without sarking or similar materials which would prevent venting through gaps between the tiles.

HEALTH AND AMENITY

3.8.5.3 Location of sanitary compartments

Sanitary compartments must not open directly into a kitchen or pantry unless—

- (a) access is by an airlock, hallway or other room, (see **Figure 3.8.5.2**); or
- (b) the room containing the closet pan is provided with mechanical exhaust ventilation.

Figure 3.8.5.2

ACCEPTABLE LOCATION OF NON MECHANICALLY VENTILATED SANITARY COMPARTMENT

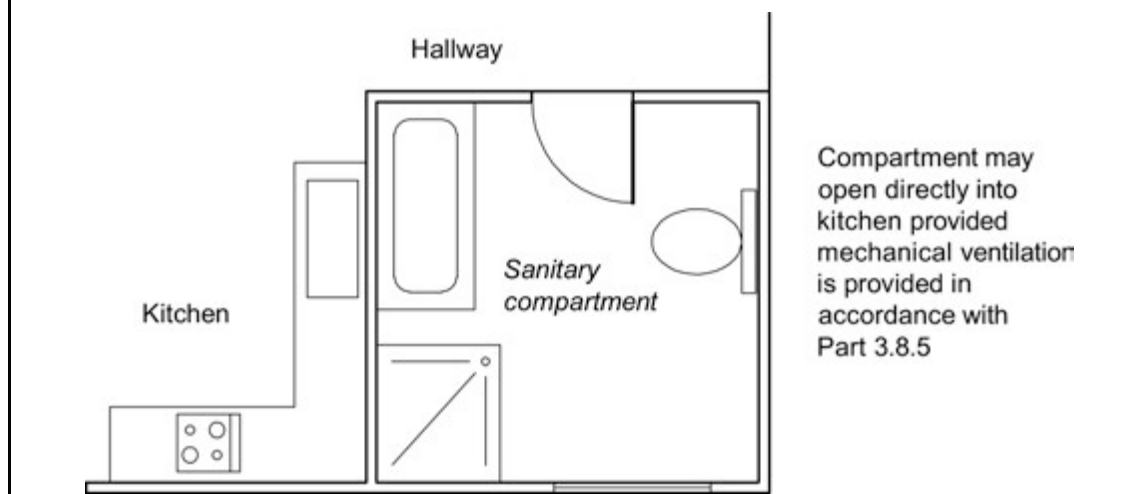

PART 3.8.6 SOUND INSULATION

Appropriate *Performance Requirements*:

Where an alternative sound insulation system is proposed as an *Alternative Solution* to that described in **Part 3.8.6**, that proposal must comply with—

- (a) *Performance Requirement P2.4.6*; and
- (b) the relevant *Performance Requirements* determined in accordance with **1.0.10**.

Acceptable construction practice

3.8.6.1 Application

Compliance with this acceptable construction practice satisfies *Performance Requirement P2.4.6* for sound insulation.

3.8.6.2 Sound insulation requirements

- (a) To provide insulation from airborne and impact sound, a *separating wall* between two or more Class 1 buildings must—
 - (i) achieve the weighted sound reduction index with spectrum adaptation term ($R_w + C_{tr}$) and discontinuous construction requirements, as *required* by **Table 3.8.6.1**; and
 - (ii) be installed in accordance with the appropriate requirements of **3.8.6.3** and **3.8.6.4**.
- (b) For the purpose of this Part, the $R_w + C_{tr}$ must be determined in accordance with AS/NZS 1276.1 or ISO 717.1, using results from laboratory measurements.

Table 3.8.6.1 REQUIRED R_w AIRBORNE AND IMPACT SOUND LEVELS FOR SEPARATING WALLS

SEPARATING WALL — LOCATION AND PENETRATIONS	DISCONTINUOUS CONSTRUCTION REQUIRED	$R_w + C_{tr}$ (As per Table 3.8.6.2)
Between a bathroom, <i>sanitary compartment</i> , laundry or kitchen and a <i>habitable room</i> (other than a kitchen) in an adjoining Class 1 building (dwelling) (see Figure 3.8.6.1).	YES	50
In all other cases to those listed above (See Figure 3.8.6.1).	NO	50

HEALTH AND AMENITY

Table 3.8.6.1 REQUIRED R_w AIRBORNE AND IMPACT SOUND LEVELS FOR SEPARATING WALLS— continued

SEPARATING WALL — LOCATION AND PENETRATIONS	DISCONTINUOUS CONSTRUCTION REQUIRED	$R_w + C_{tr}$ (As per Table 3.8.6.2)
DUCT, SOIL, WASTE, AND WATER SUPPLY PIPES AND STORM WATER PIPES A duct, soil, waste, or water supply pipe or storm water pipe that passes through a separating wall between Class 1 buildings— (a) if the adjacent room is a <i>habitable room</i> (other than a kitchen); or	NO	40
(b) if the room is a kitchen or any other room.	NO	25
Notes: 1. Discontinuous construction means a wall system having a minimum 20 mm <i>cavity</i> between two separate leaves, with— (a) for masonry, where wall ties are <i>required</i> to connect leaves, the ties are of the resilient type; and (b) for other than masonry, there is no mechanical linkage between leaves except at the periphery. 2. A staggered stud wall is not deemed to be discontinuous construction.		

HEALTH AND AMENITY

Figure 3.8.6.1

REQUIRED AIRBORNE AND IMPACT SOUND INSULATION — PLAN VIEW

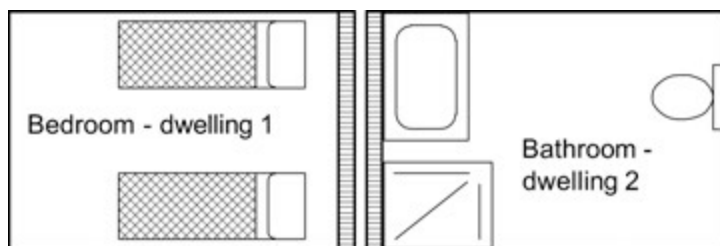

$R_w + C_{tr} 50$
and
discontinuous construction

(a) Adjoining bedroom/bathroom

Waste pipe - must be separated from the adjoining dwelling if it passes through a separating wall, by a wall with a $R_w + C_{tr} 40$, this may be reduced to a $R_w + C_{tr} 25$ if the adjoining room is kitchen



$R_w + C_{tr} 50$

(b) Adjoining bedrooms**3.8.6.3 General installation requirements for walls**

- (a) To achieve the appropriate level of sound insulation, *walls* must—
- (i) be constructed in accordance with the appropriate requirements contained in **(b)** to **(f)**; and
 - (ii) at the junction of sound insulated walls with any perimeter walls and roof cladding, be sealed in accordance with **Figure 3.8.6.2**.

HEALTH AND AMENITY

Figure 3.8.6.2

SOUND INSULATION BETWEEN BUILDINGS - STAGGERED STUD WALL CONFIGURATION

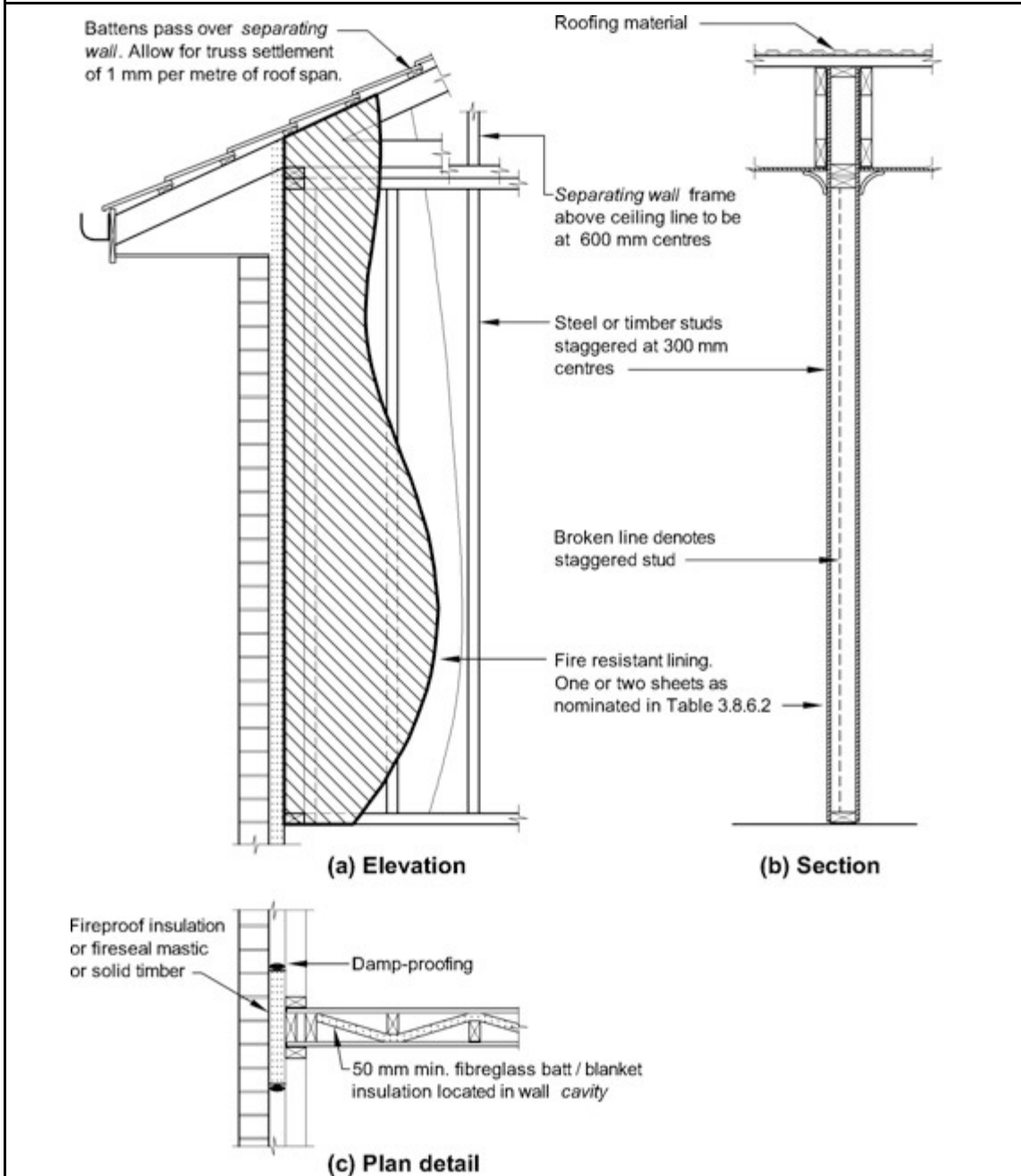

- (b) Masonry units must be laid with all joints filled solid, except for adequately sound insulated articulation joints, including those between the masonry and any adjoining construction.

HEALTH AND AMENITY

- (c) Concrete panels must have joints between panels and any adjoining construction filled solid.
- (d) Plasterboard must be installed as follows:
- (i) If one layer is *required* on both sides of a wall the joints must be staggered on opposite sides (See [Figure 3.8.6.3](#)).
 - (ii) If two layers are *required*, the first layer must be fastened in accordance with (i) and the second layer joints must not coincide with those of the first layer (See [Figure 3.8.6.3](#)).
 - (iii) The following joints must be taped and filled solid:
 - (A) Outer layer joints between sheets.
 - (B) Joints between sheets and any adjoining construction.

Figure 3.8.6.3

TYPICAL INSTALLATION OF PLASTER SHEETS FOR SOUND INSULATION

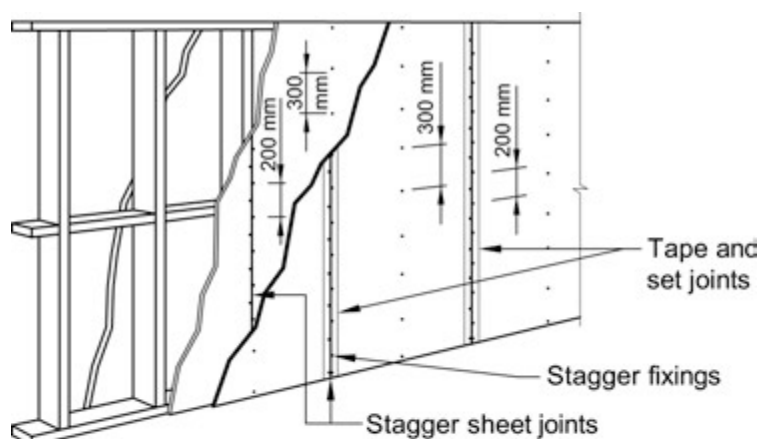

(a) Second layer positioned vertically

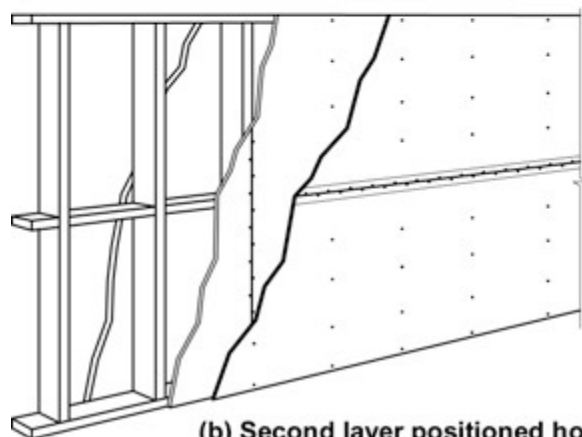

(b) Second layer positioned horizontally

- (e) Steel framing and perimeter members must be installed as follows:
- (i) The section of steel must be not less than 0.6 mm thick.

HEALTH AND AMENITY



- (ii) Studs must be not less than 63 mm in depth unless another depth is specified in [Table 3.8.6.2](#).
 - (iii) Studs must be fixed to steel top and bottom plates of sufficient depth to permit secure fixing of the plasterboard.
 - (iv) All steel members at the perimeter of the wall must be securely fixed to the adjoining structure and bedded in resilient compound or the joints must be caulked so that there are no voids between the steel members and the wall.
- (f) Timber studs and perimeter members must be installed as follows:
- (i) Studs must be fixed to top and bottom plates of sufficient depth to permit secure fixing of the plasterboard.
 - (ii) Noggings and like members must not bridge between studs supporting different wall leaves.
 - (iii) All timber members at the perimeter of the wall must be securely fixed to the adjoining structure and bedded in resilient compound or the joints must be caulked so there are no voids between the timber members and the wall.

3.8.6.4 Services

- (a) Services must not be chased into concrete or masonry *separating walls*.
- (b) If a duct, soil, waste, water supply or storm water pipe serves or passes through a *separating wall* or is located in a *separating wall*—
 - (i) a door or panel providing access to a duct or pipe *required* to be separated must—
 - (A) not open into any *habitable room*, other than a kitchen; and
 - (B) in any other part must be firmly fixed so as to overlap the frame or rebate of the frame by not less than 10 mm and be constructed of—
 - (aa) wood, plasterboard or blockboard not less than 33 mm thick; or
 - (bb) compressed fibre reinforced cement sheeting not less than 9 mm thick; or
 - (cc) other suitable material with a mass per unit area not less than 24.4 kg/m²; and
 - (ii) in the case of a water supply pipe, it must—
 - (A) only be installed in discontinuous construction; and
 - (B) in the case of a water supply pipe that serves one dwelling, not be fixed to the wall leaf on the side of any other dwelling and have a clearance not less than 10 mm to the other wall leaf.
- (c) Electrical outlets must be offset from each other—
 - (i) in masonry walling, not less than 100 mm; and
 - (ii) in timber or steel framed walling, not less than 300 mm.

HEALTH AND AMENITY

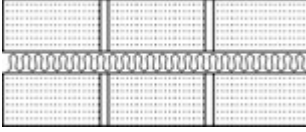
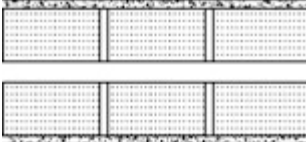
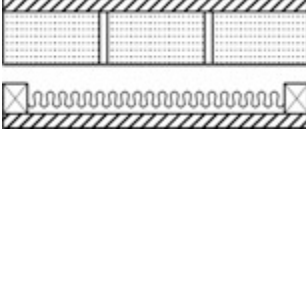
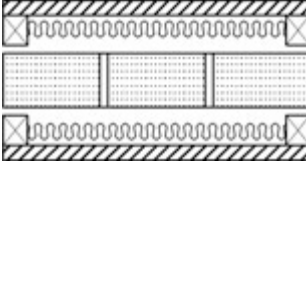
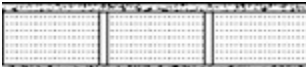
Table 3.8.6.2 ACCEPTABLE FORMS OF CONSTRUCTION

Description	$R_w + C_{tr}$ (not less than)	Construction
Wall construction type: Masonry		
Two leaves of 110 mm clay brick masonry with— (a) <i>cavity</i> not less than 50 mm between leaves; and (b) 50 mm thick glass wool insulation with a density of 11 kg/m ³ or 50 mm thick polyester insulation with a density of 20 kg/m ³ in the <i>cavity</i> .	50	
Two leaves of 110 mm clay brick masonry with— (a) <i>cavity</i> not less than 50 mm between leaves; and (b) 13 mm cement render on each outside face.	50	
Single leaf of 110 mm clay brick masonry with— (a) a row of 70 mm x 35 mm timber studs or 64 mm steel studs at 600 mm centres, spaced 20 mm from the masonry wall; and (b) 50 mm thick mineral insulation or glass wool insulation with a density of 11 kg/m ³ positioned between studs; and (c) one layer of 13 mm plasterboard fixed to outside face of studs and outside face of masonry.	50	
Single leaf of 90 mm clay brick masonry with— (a) a row of 70 mm x 35 mm timber studs or 64 mm steel studs at 600 mm centres, spaced 20 mm from each face of the masonry wall; and (b) 50 mm thick mineral insulation or glass wool insulation with a density of 11 kg/m ³ positioned between studs in each row; and (c) one layer of 13 mm plasterboard fixed to studs on each outside face.	50	
Single leaf of 220 mm brick masonry with 13 mm cement render on each face.	50	
Wall construction type: Concrete		
150 mm thick plain off form concrete.	50	
200 mm thick concrete panel with one layer of 13 mm plasterboard or 13 mm cement render on each face.	50	

HEALTH AND AMENITY

Table 3.8.6.2 ACCEPTABLE FORMS OF CONSTRUCTION — continued

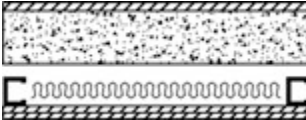
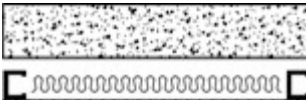
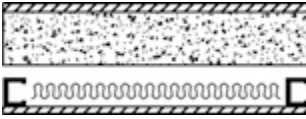
Description	$R_w + C_{tr}$ (not less than)	Construction
100 mm thick concrete panel with— (a) a row of 64 mm steel studs at 600 mm centres, spaced 25 mm from the concrete panel; and (b) 80 mm thick polyester insulation or 50 mm thick glass wool insulation with a density of 11 kg/m ³ , positioned between studs; and (c) two layers of 13 mm plasterboard fixed to outside face of studs and one layer of 13 mm plasterboard fixed to outside face of concrete panel.	50	
125 mm thick concrete panel with— (a) a row of 64 mm steel studs at 600 mm centres, spaced 20 mm from the concrete panel; and (b) 70 mm polyester insulation with a density of 9 kg/m ³ , positioned between studs; and (c) one layer of 13 mm plasterboard fixed to the outside face of the studs.	50	
Wall construction type: Autoclaved aerated concrete		
75 mm thick autoclaved aerated concrete wall panel with— (a) a row of 64 mm steel studs at 600 mm centres, spaced 20 mm from the autoclaved aerated concrete wall panel; and (b) 75 mm thick glass wool insulation with a density of 11 kg/m ³ positioned between studs; and (c) one layer of 10 mm moisture resistant plasterboard or 13 mm fire protective grade plasterboard fixed to outside face of studs and outside face of autoclaved aerated concrete wall panel.	50	

HEALTH AND AMENITY

Table 3.8.6.2 ACCEPTABLE FORMS OF CONSTRUCTION — continued

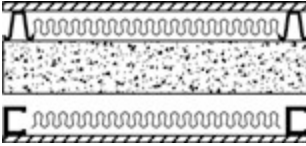
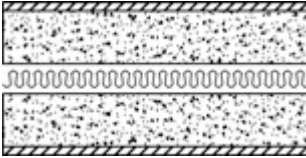
Description	$R_w + C_{tr}$ (not less than)	Construction
<p>75 mm thick autoclaved aerated concrete wall panel with—</p> <p>(a) a row of 64 mm steel studs at 600 mm centres, spaced 35 mm from the autoclaved aerated concrete panel wall; and</p> <p>(b) 28 mm metal furring channels fixed to the outside face of the autoclaved aerated concrete wall panel, with 50 mm thick polyester insulation with a density of 9 kg/m³ positioned between furring channels and one layer of 13 mm fire protective grade plasterboard fixed to furring channels; and</p> <p>(c) 105 mm thick glass wool insulation with a density of 7 kg/m³ positioned between studs; and</p> <p>(d) one layer of 13 mm fire protective grade plasterboard fixed to the outside face of the studs.</p>	50	
<p>Two leaves of 75 mm autoclaved aerated concrete wall panel with—</p> <p>(a) a <i>cavity</i> not less than 30 mm between panels containing 50 mm glass wool insulation with a density of 11 kg/m³; and</p> <p>(b) one layer of 10 mm plasterboard fixed to outside face of each panel.</p>	50	

HEALTH AND AMENITY

Table 3.8.6.2 ACCEPTABLE FORMS OF CONSTRUCTION — continued

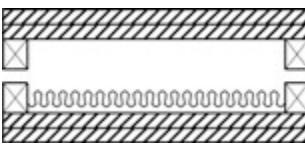
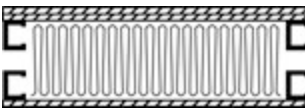
Description	$R_w + C_{tr}$ (not less than)	Construction
Wall construction type: Timber and steel framing		
Two rows of 90 x 35 mm timber studs or two rows of 64 mm steel studs at 600 mm centres with— <ul style="list-style-type: none"> (a) an air gap not less than 20 mm between the rows of studs; and (b) 50 mm thick glass wool insulation or 60 mm thick polyester insulation with a density of 11 kg/m³; positioned between one row of studs, and (c) two layers of 13 mm fire protective grade plasterboard or one layer of 6 mm fibre cement sheet and one layer of 13 mm fire protective grade plasterboard, fixed to outside face of studs. 	50	
Two rows of 64 mm steel studs at 600 mm centres with— <ul style="list-style-type: none"> (a) an air gap not less than 80 mm between the rows of studs; and (b) 200 mm thick polyester insulation with a density of 14 kg/m³; positioned between studs; and (c) one layer of 13 mm fire-protective grade plasterboard and one layer 13 mm plasterboard on one outside face and one layer of 13 mm fire-protective grade plasterboard on the other outside face. 	50	

Explanatory information:

The wall configurations shown in [Table 3.8.6.2](#) are typical examples. Other proprietary methods are available for meeting the $R_w + C_{tr}$ requirements of [3.8.6.2](#).

STATE AND TERRITORY VARIATIONS

In Northern Territory Part 3.8.6 acceptable construction practice is replaced with the following:

Acceptable construction practice**3.8.6.1 Application**

Compliance with this Part satisfies *Performance Requirement P2.4.6* for sound insulation.

3.8.6.2 Sound insulation requirements

- (a) A *separating wall* between two or more Class 1 buildings must—
 - (i) achieve the weighted sound reduction index (R_w) and impact sound resistance *required* by [Table 3.8.6.1](#); and

HEALTH AND AMENITY

- (ii) be installed in accordance with the appropriate requirements of 3.8.6.3 and 3.8.6.4; and
- (b) for the purpose of this Part, the R_w may be determined in accordance with AS/NZS 1276.1 or ISO 717.1.

Table 3.8.6.1 REQUIRED R_w AND SOUND IMPACT LEVELS FOR SEPARATING WALLS

SEPARATING WALL—LOCATION AND PENETRATIONS	IMPACT SOUND RESISTANCE (As per Table 3.8.6.2)	R_w (As per Table 3.8.6.3)
TYPE A Between a bathroom, <i>sanitary compartment</i> , laundry or kitchen and a <i>habitable room</i> (other than a kitchen) in an adjoining Class 1 building (dwelling) (see Figure 3.8.6.1).	YES	50
TYPE B In all other cases to those listed as Type A. (See Figure 3.8.6.1)	NO	45
SOIL AND WASTE PIPES A waste pipe or other penetration that serves or passes through a <i>separating wall</i> between houses—		
(a) If the adjacent room is a <i>habitable room</i> (other than a kitchen); or	NO	45
(b) If the room is a kitchen or any other room.	NO	30

HEALTH AND AMENITY

Figure 3.8.6.1

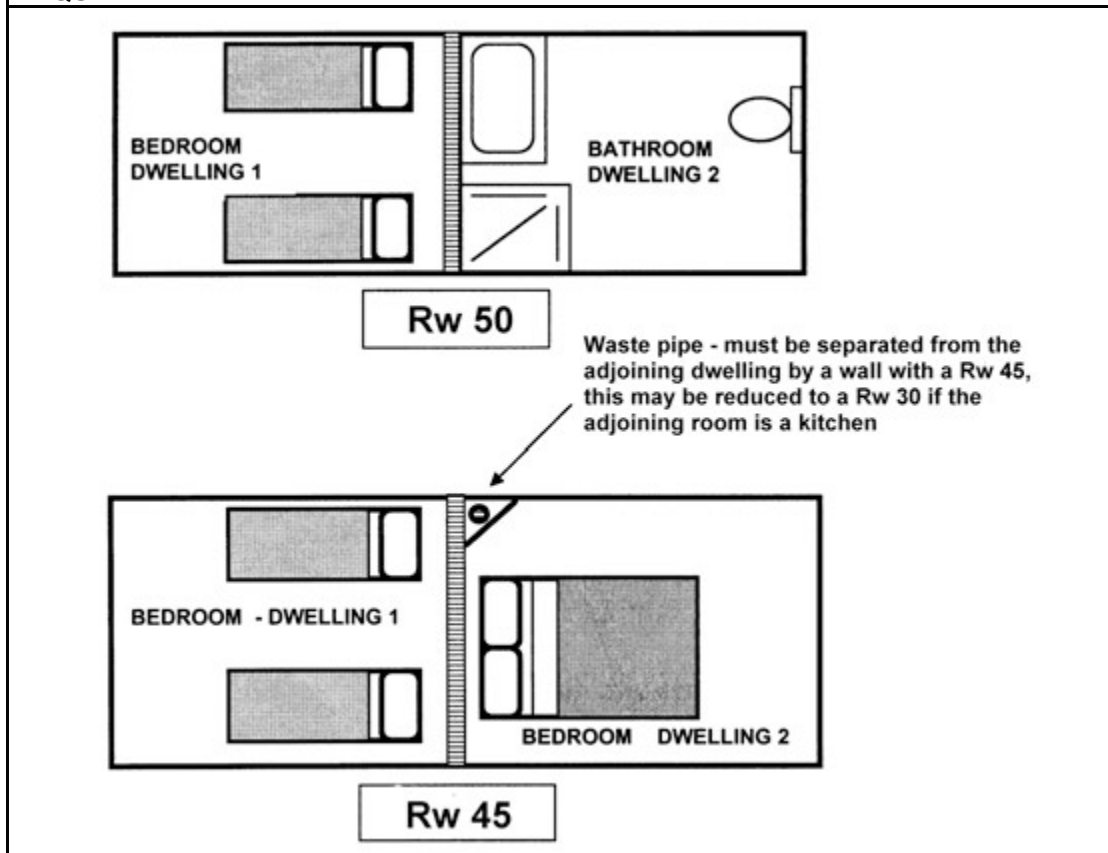
REQUIRED R_w — PLAN VIEW

3.8.6.3 General installation requirements for walls

- (a) To achieve the appropriate R_w and impact sound resistance, walls must—
 - (i) be installed in accordance with the appropriate requirements contained in (b) to (f); and
 - (ii) at the junction of sound insulated walls with perimeter walls and roof cladding, be sealed in accordance with any relevant detail in [Figure 3.8.6.3](#).
- (b) Masonry units must—
 - (i) be laid with all joints filled solid, including those between the masonry and any adjoining construction; and
 - (ii) not be chased for services.
- (c) Joints between concrete slabs, wall units and any adjoining construction must be filled solid.
- (d) Plasterboard must be installed as follows:
 - (i) If one layer is *required* under this Part, joints must be staggered with the joints in sheets on the opposite face of the wall.

HEALTH AND AMENITY

- (ii) If 2 layers are *required*, the first layer must be fixed according to (i) and the second layer must be fixed to the first layer with nails, screws or adhesive so that the joints do not coincide with those of the first layer.
- (iii) Joints between sheets or between sheets and any adjoining construction must be taped and filled solid.
- (iv) Fire-protective grade plasterboard (when nominated) must be the grade manufactured for use in *fire-resisting* construction.

Figure 3.8.6.2

TYPICAL INSTALLATION OF PLASTER SHEETS FOR SOUND INSULATION

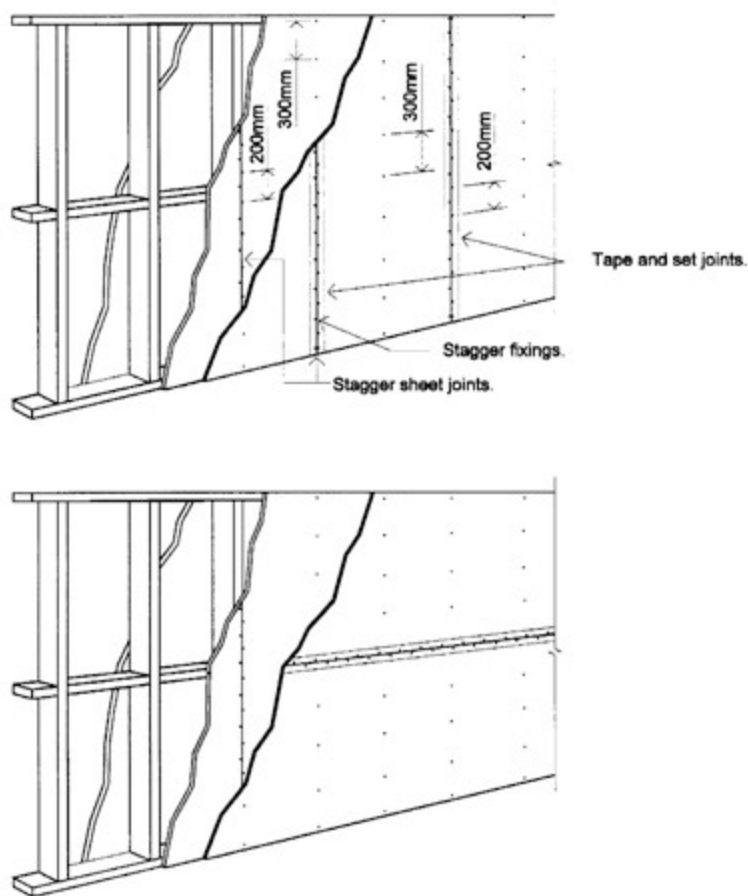

HEALTH AND AMENITY

- (e) Steel studs and perimeter members must be installed as follows:
- (i) The section of steel must be not less than 0.6 mm thick.
 - (ii) Studs must be not less than 63 mm in depth unless another depth is specified in the Table.
 - (iii) Studs must be fixed to steel top and bottom plates of sufficient depth to permit secure fixing of the plasterboard.
 - (iv) All steel members at the perimeter of the wall must be securely fixed to the adjoining structure and bedded in resilient compound or the joints must be caulked so that there are no voids between the steel members and the wall.
- (f) Timber studs and perimeter members must be installed as follows:
- (i) Studs must be fixed to top and bottom plates of sufficient depth to permit secure fixing of the plasterboard.
 - (ii) Noggings and like members must not bridge between studs supporting different wall leaves.
 - (iii) All timber members at the perimeter of the wall must be securely fixed to the adjoining structure and bedded in resilient compound or the joints must be caulked so there are no voids between the timber members and the wall.

3.8.6.4 Soil and waste pipes

If a soil or waste pipe passes through a *separating wall*—

- (a) a door or panel providing access to the pipe must not open into any *habitable room*, other than a kitchen; and
- (b) an access door or panel in any other part must be firmly fixed so as to overlap the frame or rebate of the frame by not less than 10 mm, be fitted with a sealing gasket along all edges and constructed of—
 - (i) wood, plasterboard or blockboard not less than 38 mm thick; or
 - (ii) compressed fibre reinforced cement sheeting not less than 9 mm thick; or
 - (iii) other suitable material with a mass per unit area not less than 24.4 kg/m².

Explanatory information:

The wall configurations shown in **Tables 3.8.6.2** and **3.8.6.3** are typical examples. Other proprietary methods are available for meeting the R_w and sound impact levels *required* by **Table 3.8.6.1**.

HEALTH AND AMENITY

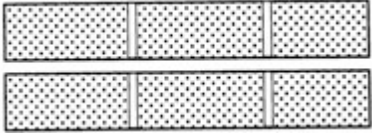
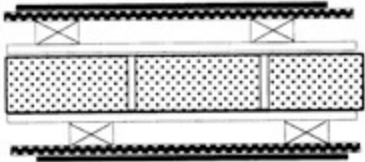
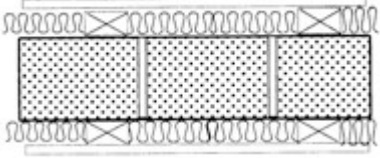
Table 3.8.6.2	
CONSTRUCTION OF WALLS TO: (A) REDUCE IMPACT SOUND; AND (B) ACHIEVE A 50 Rw	
WALL CONSTRUCTION TYPE	DESIGN DIAGRAM — PLAN VIEW
<p>CAVITY BRICKWORK</p> <p>2 leaves 90 mm brick masonry with—</p> <ul style="list-style-type: none"> (a) all joints filled solid with mortar; and (b) an air space not less than 40 mm between the leaves; and (c) the leaves connected only by ties in accordance with AS 3700 and wall tie spacing details as set out in Part 3.3. 	
<p>SINGLE LEAF BRICKWORK</p> <p>80 mm thick brick masonry with—</p> <ul style="list-style-type: none"> (a) each face rendered 13 mm thick; and (b) 50x12 mm thick timber battens at not more than 610 mm centres fixed to each face but not recessed into the render; and (c) one layer of 12 mm thick softboard nailed to the battens; and (d) 6 mm thick medium density hardboard adhesive-fixed to the softboard. 	
<p>CONCRETE BLOCKWORK</p> <p>190 mm thick concrete block masonry with—</p> <ul style="list-style-type: none"> (a) each face of the blocks fitted with 50x50 mm timber battens, spaced at not more than 610 mm centres, screw-fixed into resilient plugs with rubber inserts; and (b) the space between the battens completely filled with mineral or glass wool blanket or batts not less than 50 mm thick; and (c) the outer face of the battens finished with plasterboard not less than 10 mm thick. 	

HEALTH AND AMENITY

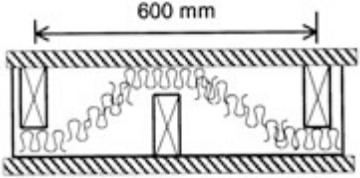

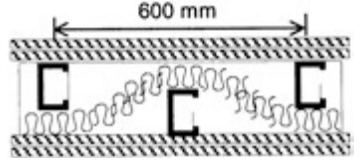
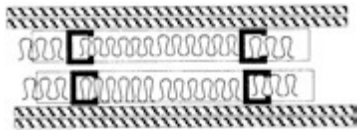

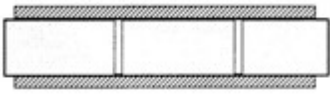
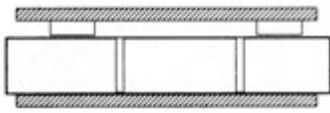

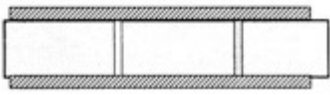



Table 3.8.6.2	
CONSTRUCTION OF WALLS TO: (A) REDUCE IMPACT SOUND; AND (B) ACHIEVE A 50 Rw	
WALL CONSTRUCTION TYPE	DESIGN DIAGRAM — PLAN VIEW
<p>TIMBER FRAMED WALLING</p> <p>70 x 45 mm F5 staggered timber studs at 600 mm centres both sides on 120x35 mm F5 timber plates with—</p> <p>(a) one layer of 16 mm fire protective grade plasterboard on both faces; and</p> <p>(b) 50 mm glass fibre batts.</p>	
<p>TIMBER FRAMED WALLING</p> <p>70 x 45 mm F5 timber double studs at 450 – 600 mm centres with an air space not less than 20 mm between studs with two layers of 13 mm fire protective grade plasterboard on both faces.</p>	
<p>STEEL STUD WALLING</p> <p>64 mm staggered metal studs (0.75 mm base metal thickness) at 600 mm centres both sides, clipped in 92 mm metal tracks with—</p> <p>(a) two layers of 13 mm fire protective grade plasterboard to each side; and</p> <p>(b) 50 mm glasswool <i>cavity</i> batts.</p>	
<p>STEEL STUD WALLING</p> <p>64 mm double metal studs (0.75 mm base metal thickness) at 600 mm centres with an air space not less than 20 mm between studs, in separate frames with no mechanical links with—</p> <p>(a) two layers of 13 mm fire protective grade plasterboard to each side; and</p> <p>(b) 50 mm glasswool <i>cavity</i> batts.</p>	

Table 3.8.6.3





Rw APPLICABLE TO CONSTRUCTION

WALL CONSTRUCTION TYPE	Rw	DESIGN DIAGRAM — PLAN VIEW
CLAY BRICKWORK		
(a) 110 mm thick in one or more leaves and with a mass per unit area of not less than 290 kg/m ² .	45	

HEALTH AND AMENITY

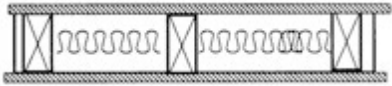
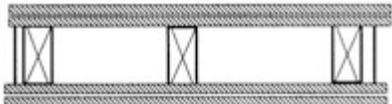
Table 3.8.6.3		
R_w APPLICABLE TO CONSTRUCTION		
WALL CONSTRUCTION TYPE	R_w	DESIGN DIAGRAM — PLAN VIEW
(b) 80 mm thick, pressed brick and rendered 13 mm on one side, the mass per unit area of the unrendered wall being not less than 215 kg/m ² .	45	
CALCIUM SILICATE BRICKWORK		
(a) 90 mm thick calcium silicate brick with one layer of 10 mm fire protective grade plasterboard on each side.	45	
(b) 90 mm thick calcium silicate brick with one layer of 10 mm fire protective plasterboard and one layer of fire protective plasterboard on metal furring channels.	45	
CONCRETE BLOCKWORK		
(a) 190 mm solid units (or thicker) Material density 2200 kg/m ³	45	
(b) 110 mm solid units (or thicker) Material density 2200 kg/m ³ Material thickness — 83 mm min. 10 mm plasterboard or 12 mm render on each face.	45	
CONCRETE WALL		
In-situ concrete — 125 mm thick and with a density of not less than 2200 kg/m ³ .	45	
STEEL STUD WALLING		
(a) With 2 layers of 16 mm thick fire-protective grade plasterboard fixed to each face.	45	
(b) With 2 layers of 13 mm plasterboard on both sides of 75 mm studs.	45	

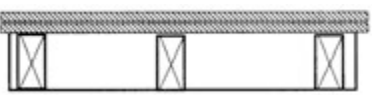
HEALTH AND AMENITY

Table 3.8.6.3		
Rw APPLICABLE TO CONSTRUCTION		
WALL CONSTRUCTION TYPE	Rw	DESIGN DIAGRAM — PLAN VIEW
TIMBER STUD WALLING		
70 x 45 mm timber studs at 450 – 600 mm centres with (a) one layer of 16 mm fire protective grade plasterboard on one face; and (b) 50 mm glass fibre batts; and (c) one layer of 16 mm fire protective grade plasterboard on metal resilient channel.	49	
70 x 45 mm timber studs at 450 – 600 mm centres with two layers of 16 mm fire protective grade plasterboard on both sides.	46	
DUCTS OR OTHER CONSTRUCTION SEPARATING SOIL AND WASTE PIPES FROM UNITS		
MASONRY		
Not less than 90 mm thick.	30	
PLASTERBOARD		
(a) 2 layers of plasterboard each 10 mm thick, fixed to timber studs not less than 75x50 mm and spaced at not more than 400 mm centres.	30	
(b) 2 layers of plasterboard each 13 mm thick, one on each side of steel studs not less than 50 mm deep and spaced at not more than 400 mm centres.	30	

HEALTH AND AMENITY

Figure 3.8.6.3

SOUND INSULATION BETWEEN UNITS — DOUBLE STUD WALL CONFIGURATION

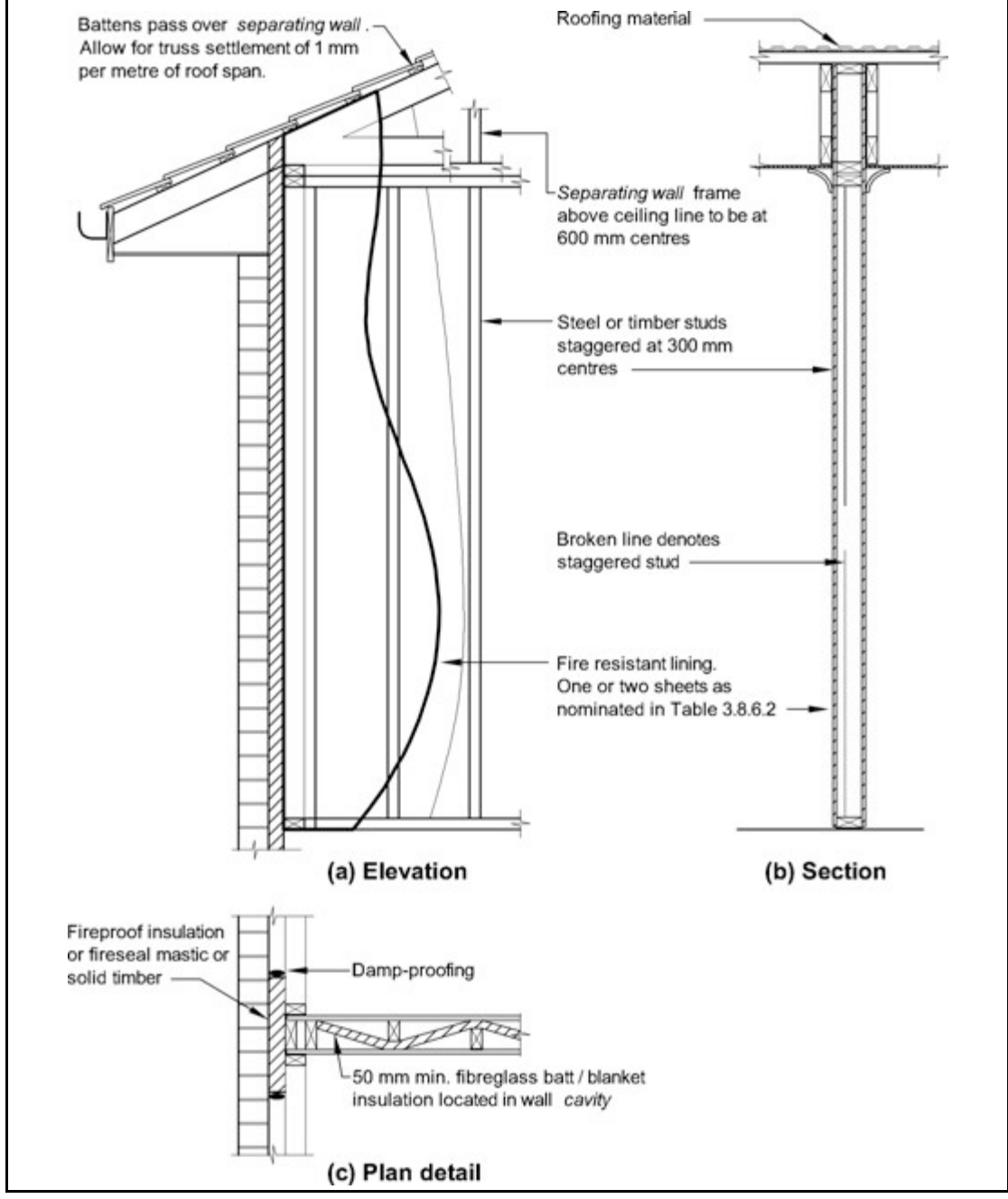

PART **3.9**

SAFE MOVEMENT AND ACCESS

- 3.9.1 Stair Construction**
- 3.9.2 Barriers and Handrails**
- 3.9.3 Swimming Pool Access**
- 3.9.4 Swimming Pool Water Recirculation Systems**

PART 3.9 CONTENTS

PART 3.9 SAFE MOVEMENT AND ACCESS

3.9.1 Stair construction

- 3.9.1 Definitions
 - 3.9.1.1 Application
 - 3.9.1.2 General requirements
 - 3.9.1.3 Stair construction
 - 3.9.1.4 Riser and going dimensions
 - 3.9.1.5 Thresholds

3.9.2 Barriers and handrails

- 3.9.2.1 Application
- 3.9.2.2 Barriers to prevent falls
- 3.9.2.3 Construction of barriers to prevent falls
- 3.9.2.4 Handrails
- 3.9.2.5 Protection of openable windows

3.9.3 Swimming pool access

- 3.9.3.0 Acceptable construction manuals

3.9.4 Swimming pool water recirculation systems

- 3.9.4.0 Acceptable construction manual

PART 3.9.1 STAIR CONSTRUCTION

Appropriate *Performance Requirements*:

Where an alternative stair system is proposed as an *Alternative Solution* to that described in **Part 3.9.1**, that proposal must comply with—

- (a) *Performance Requirement P2.5.1*; and
- (b) the relevant *Performance Requirements* determined in accordance with **1.0.10**.

Definitions

3.9.1

The following definitions are used in this Part:

Flight means that part of a stair that has a continuous series of *risers*, including *risers* of *winders*, not interrupted by a *landing* or floor (see **Figure 3.9.1.1**).

Explanatory information:

A *flight* is the area of a stair that has a continuous slope created by the nosing line of treads. The length of a *flight* is limited to restrict the distance a person could fall down a stair. Quarter *landings*, as shown in **Figure 3.9.1.1**, are considered sufficient to halt a person’s fall and therefore are considered for the purposes of this document not to be part of the *flight*.

Figure 3.9.1.1
IDENTIFICATION OF STAIR FLIGHTS — Plan view

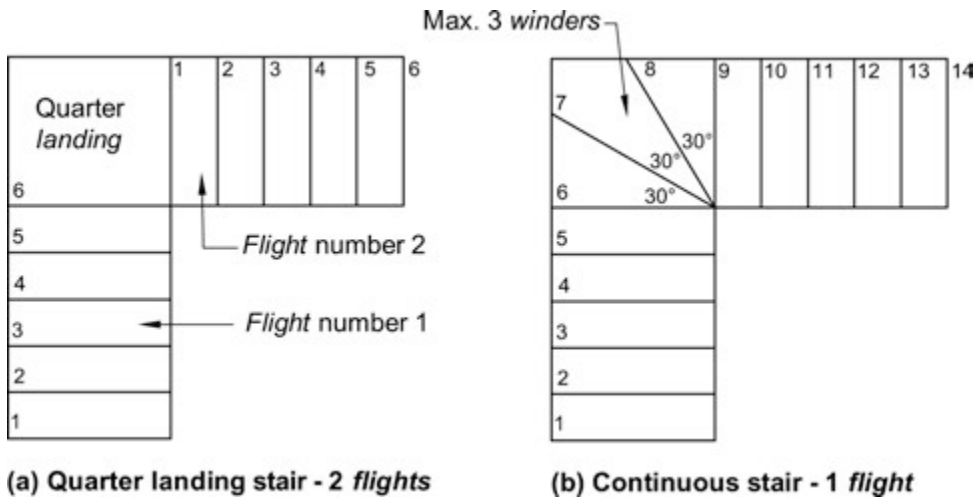

SAFE MOVEMENT AND ACCESS

Going means the horizontal dimension from the front to the back of a tread less any overhang from the next tread above (see [Figure 3.9.1.2](#)).

Landing means an area at the top or bottom of a *flight* or between two *flights*.

Riser means the height between consecutive treads.

Spiral stair means a stair with a circular plan, winding around a central post with steps that radiate from a common centre or several radii (see [Figure 3.9.1.4](#)).

Tapered tread means a stair tread with a walking area that grows smaller towards one end.

Winders means treads within a straight *flight* that are used to change direction of the stair (see [Figure 3.9.1.1](#)).

Acceptable construction practice

3.9.1.1 Application

Compliance with this acceptable construction practice satisfies [Performance Requirement P2.5.1](#), provided the stair complies with the appropriate structural requirements of the [Housing Provisions](#).

3.9.1.2 General requirements

- (a) Stairs serving *habitable rooms*, including external stairs must comply with [3.9.1.3](#) and [3.9.1.4](#).
- (b) Stairs serving only non-*habitable rooms*, such as attics, storerooms and the like that are not used on a regular or daily basis, must be constructed in accordance with—
 - (i) the provisions of this Part; or
 - (ii) AS 1657.

3.9.1.3 Stair construction

Stairs must be constructed in accordance with the following:

- (a) Each *flight* must have not more than 18 nor less than 2 *risers*.
- (b) The nominal dimension of *goings* and *risers* of a stair must be constant throughout each stair *flight* except that the *going* of *winders* in lieu of a quarter or half *landing* may vary from the *going* of the straight treads within the same *flight* provided that the *going* of all such *winders* is constant.
- (c) Treads must be of solid construction (not mesh or other perforated material) if the stairway is more than 10 m high or connects more than 3 storeys.
- (d) A *flight* of stairs must not have more than 3 *winders* in lieu of each quarter *landing* or 6 *winders* in lieu of each half *landing*.
- (e) The *riser* opening must not allow a 125 mm sphere to pass through between the treads.
- (f) * * * * *
- (g) Treads must have—

SAFE MOVEMENT AND ACCESS

- (i) a surface with a slip-resistance classification not less than that listed in [Table 3.9.1.1](#) when tested in accordance with AS 4586; or
- (ii) a nosing strip with a slip-resistance classification not less than that listed in [Table 3.9.1.1](#) when tested in accordance with AS 4586.

STATE AND TERRITORY VARIATIONS

In Queensland delete 3.9.1.3(g) and Table 3.9.1.1 and insert QLD 3.9.1.3(g) as follows:

- (g) Treads must have a slip-resistant finish or a suitable non-skid strip near the edge of the nosings.

In Tasmania delete 3.9.1.3(g) and Table 3.9.1.1 and insert Tas 3.9.1.3(g) as follows:

- (g) Treads must have a slip-resistant finish or a suitable non-skid strip near the edge of the nosings.

Table 3.9.1.1 SLIP-RESISTANCE CLASSIFICATION

Application	Surface conditions	
	Dry	Wet
Tread surface	P3 or R10	P4 or R11
Nosing strip	P3	P4

Explanatory information:

To determine the appropriate surface of a tread, it is necessary to determine the likely conditions the tread will be subject to over the life of the building. This can either be dry, wet or both.

A dry surface is one that is not normally wet or likely to be made wet other than by an accidental spill.

A wet surface is one that is normally wet or likely to be made wet, including areas exposed to weather.

- (h) *Landings* must—
 - (i) be not less than 750 mm long and where this involves a change in direction, the length is measured 500 mm from the inside edge of the *landing* (see [Figure 3.9.1.5](#), Diagram a); and
 - (ii) have a gradient not steeper than 1:50; and
 - (iii) be provided where the sill of a threshold of a doorway opens on to a stair that provides a change in floor level or floor to ground level greater than 3 *risers* or 570 mm (see [Figure 3.9.1.5](#), Diagram b); and
 - (iv) extend across the full width of a doorway.

Explanatory information:

[3.8.2.2](#) contains the *required* height for a ceiling in a stairway, measured vertically from the nosing line.

SAFE MOVEMENT AND ACCESS

3.9.1.4 Riser and going dimensions

The *riser* and *going* dimensions for each *flight*, except for the *going* of *winders* in lieu of a quarter or half *landing*, must comply with the following:

- (a) The *going* (G), *riser* (R) and slope relationship quantity ($2R+G$) must be in accordance with **Figure 3.9.1.2**.
- (b) The point for measurement of the *going* (G) in the slope relationship quantity as described in **Figure 3.9.1.3** must be—
 - (i) for *tapered treads* (other than treads in a *spiral stair*)—
 - (A) not more than 1 m wide, the middle of the unobstructed width of the stair (see **Figure 3.9.1.3**, Diagram b); and
 - (B) more than 1 m in width, 400 mm from the unobstructed width of each side of the stair (see **Figure 3.9.1.3**, Diagram c); and
 - (ii) for treads in *spiral stairs*, the point seven tenths of the unobstructed distance from the face of the centre pole or support towards the handrail side (see **Figure 3.9.1.4**).

Figure 3.9.1.2

STAIR RISER AND GOING DIMENSIONS (mm)

STAIR TYPE	RISER (R)		GOING (G)		SLOPE RELATIONSHIP ($2R+G$)	
	(see Figure below)		(see Figure below)		(see Figure below)	
	Max	Min	Max	Min	Max	Min
Stairs (other than spiral)	190	115	355	240	700	550
Spiral	220	140	370	210	680	590

125 mm sphere must not pass through treads

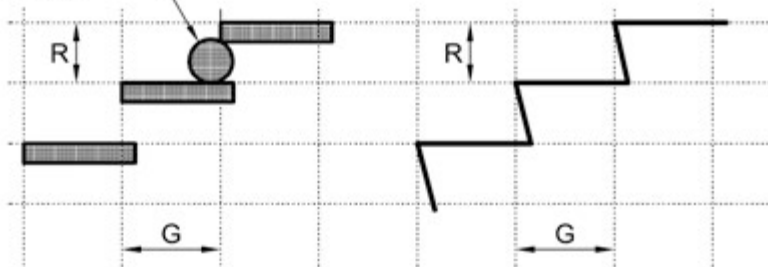

SAFE MOVEMENT AND ACCESS

Figure 3.9.1.3

MEASUREMENT OF SLOPE RELATIONSHIP — Plan view

Diagram a. Stair with 2 flights

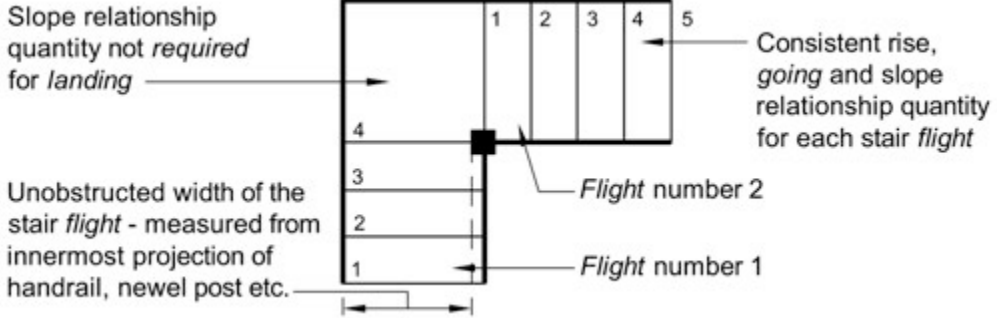

Diagram b. Tapered treads — not more than 1 m wide

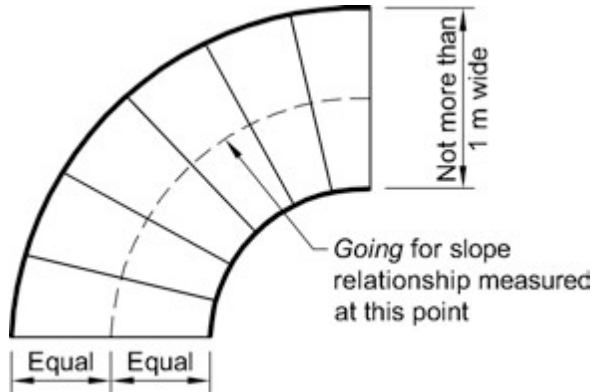
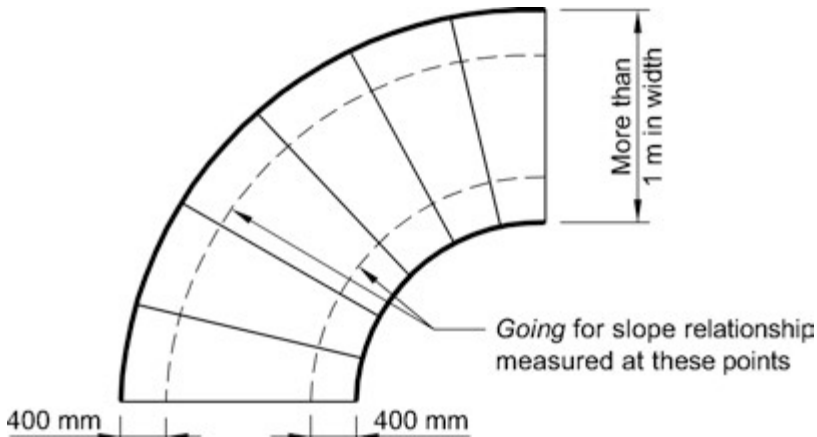

Diagram c. Tapered treads — more than 1 m in width



SAFE MOVEMENT AND ACCESS

Figure 3.9.1.4

SPIRAL STAIRS

Diagram a. Measurement for slope relationship

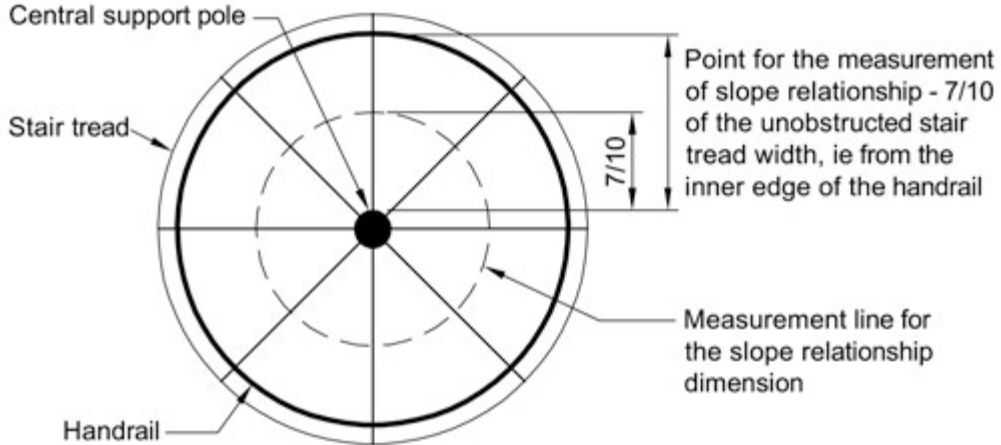
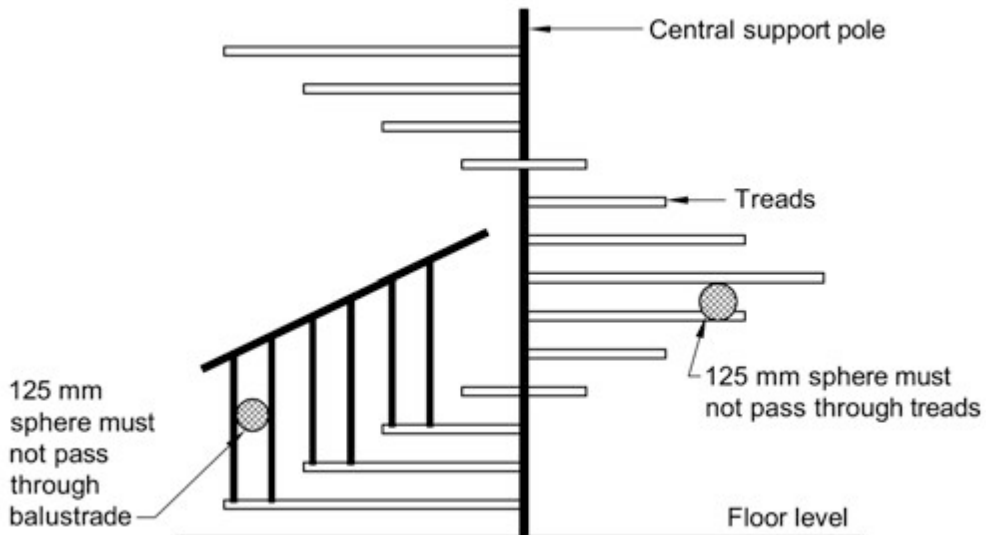

Diagram b. Measurement for openings in stairs



SAFE MOVEMENT AND ACCESS

Figure 3.9.1.5

LANDINGS

Diagram a. Stairway landing

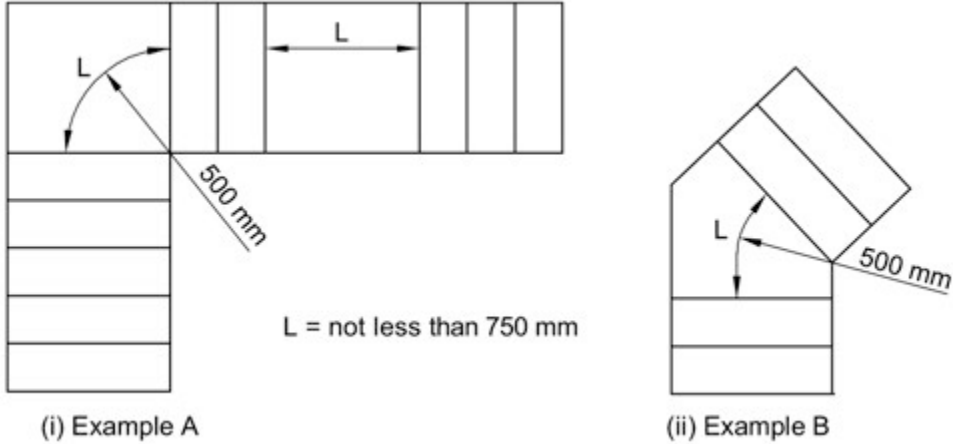
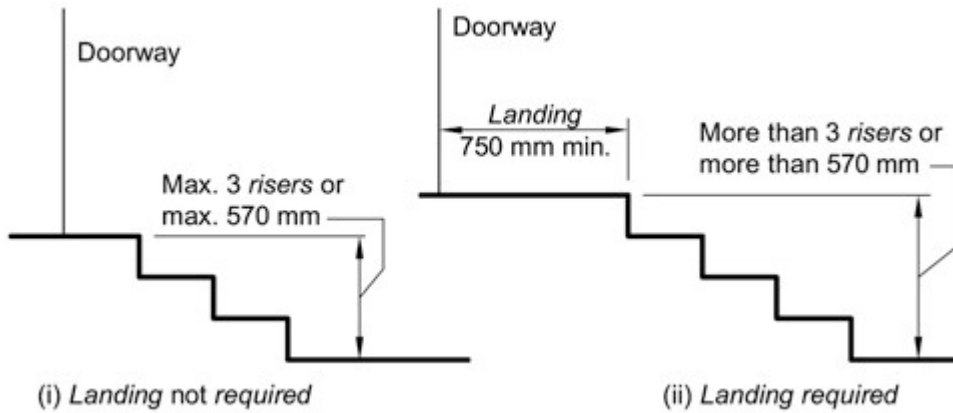

Diagram b. Threshold landing



3.9.1.5 Thresholds

Where a threshold is more than 190 mm above the adjoining surface it must incorporate steps having *riser* and *going* dimensions in accordance with [3.9.1.4](#)

PART 3.9.2 BARRIERS AND HANDRAILS

Appropriate *Performance Requirements*:

- (a) Where an alternative barrier is proposed as an *Alternative Solution* to that described in **Part 3.9.2**, that proposal must comply with—
 - (i) *Performance Requirement P2.1.1*; and
 - (ii) *Performance Requirement P2.5.2*; and
 - (iii) the relevant *Performance Requirements* determined in accordance with **1.0.10**.
- (b) Where an alternative handrail is proposed as an *Alternative Solution* to that described in **Part 3.9.2**, that proposal must comply with—
 - (i) *Performance Requirement P2.1.1*; and
 - (ii) *Performance Requirement P2.5.1(b)(i)*; and
 - (iii) the relevant *Performance Requirements* determined in accordance with **1.0.10**.

Acceptable construction practice

3.9.2.1 Application

Compliance with this acceptable construction practice satisfies *Performance Requirements P2.5.2* for barriers and *P2.5.1(b)(i)* for handrails.

3.9.2.2 Barriers to prevent falls

- (a) A continuous barrier must be provided along the side of—
 - (i) any roof to which general access is provided; and
 - (ii) any stairway or ramp; and
 - (iii) a floor, corridor, hallway, balcony, deck, verandah, mezzanine, access bridge or the like; and
 - (iv) any delineated path of access to a building,
if the trafficable surface is 1 m or more above the surface beneath (see **Figure 3.9.2.3**).
- (b) The requirements of (a) do not apply to—
 - (i) areas referred to in **3.9.1.2(b)**; or
 - (ii) a retaining wall unless the retaining wall forms part of, or is directly associated with a delineated path of access to a building from the road, or a delineated path of access between buildings; or
 - (iii) a barrier provided to an openable window covered by **3.9.2.5**.

SAFE MOVEMENT AND ACCESS

3.9.2.3 Construction of barriers to prevent falls

- (a) The height of a barrier *required* by 3.9.2.2 must be in accordance with the following:
- (i) The height must not be less than 865 mm above the nosings of the stair treads or the floor of a ramp.
 - (ii) The height must not be less than—
 - (A) 1 m above the floor of any access path, balcony, *landing* or the like (see [Figure 3.9.2.1](#)); or
 - (B) 865 mm above the floor of a *landing* to a stair or ramp where the barrier is provided along the inside edge of the *landing* and does not exceed a length of 500 mm.
- (b) A transition zone may be incorporated where the barrier height changes from 865 mm on the stair *flight* or ramp to 1 m at the *landing* (see [Figure 3.9.2.2](#)).
- (c) Openings in barriers (including decorative balustrades) must be constructed so that they do not permit a 125 mm sphere to pass through it and for stairs, the opening is measured above the nosing line of the stair treads.
- (d) A barrier, except a window serving as a barrier, must be designed to take loading forces in accordance with AS/NZS 1170.1.

Explanatory Information:

A window forming part of a barrier is not *required* to comply with AS/NZS 1170.1 as it is exempted by 3.9.2.3(d). However, a window serving as a barrier must comply with the glazing assembly provisions of AS 2047 or AS 1288. These provisions consider the wind loading on the glass and human impact requirements.

- (e) For floors more than 4 m above the surface beneath, any horizontal elements within the barrier between 150 mm and 760 mm above the floor must not facilitate climbing.

Explanatory Information:

For a *window* forming part of a barrier, a *window* sill between 150 mm and 760 mm above the floor is deemed to facilitate climbing.

- (f) Where a *required* barrier is constructed of wire it is deemed to meet the requirements of (c) if it is constructed in accordance with the following:
- (i) For horizontal wire systems—
 - (A) when measured with a strain indicator, it must be in accordance with the tension values in [Table 3.9.2.1](#); or
 - (B) must not exceed the maximum deflections in [Table 3.9.2.3](#).
 - (ii) For non-continuous vertical wire systems, when measured with a strain indicator, must be in accordance with the tension values in [Table 3.9.2.1](#) (see Note 4).
 - (iii) For continuous vertical or continuous near vertical sloped wire systems—
 - (A) must have wires of no more than 2.5 mm diameter with a lay of 7×7 or 7×19 construction; and
 - (B) changes in direction at support rails must pass around a pulley block without causing permanent deformation to the wire; and

SAFE MOVEMENT AND ACCESS

- (C) must have supporting rails, constructed with a spacing of not more than 900 mm, of a material that does not allow deflection that would decrease the tension of the wire under load; and
- (D) when the wire tension is measured with a strain indicator, it must be in accordance with the tension values in [Table 3.9.2.2](#) and measured in the furthest span from the tensioning device.

Explanatory information:

1. For the purpose of this clause, a wire barrier consist of a series of tensioned wire rope connected to either vertical or horizontal supports serving as a guard to minimise the risk of a person falling from a roof, stairway, raised floor level or the like.
2. A wire barrier excludes wire mesh fences and the like.
3. To assist in the application of [3.9.2.3\(f\)](#), the following terms have been defined:
 - (a) Continuous — where the wire spans three or more supports.
 - (b) Non-continuous — where the wire only spans between two supports.
 - (c) Pulley block — a device consisting of a wheel in which a wire runs around to change its direction.
 - (d) Permissible deflection — is the allowable bending of the wire.
 - (e) Support rails — are horizontal components of the barrier system that span across the top and bottom to provide structural support.
4. [Tables 3.9.2.1](#) and [3.9.2.2](#) contains tension requirements for wires in vertical wire barrier systems with varying post spacings, wire spacings and wire types. The figures contained in the table were derived from testing the spacing combinations in order to prevent the passage of a 125 mm diameter solid cone penetrating between the wires at a predetermined force.
5. Care needs to be taken to ensure that wire tension will be maintained during the life of the barrier. In some situations, it may be necessary to incorporate "lock-off" devices to prevent loosening of the wire.
6. Likewise, if a threaded anchor bears against a soft wood post or rail, the anchor may indent the post or rail, thus loosening the wire.
7. Temperature effects on the tension of the wire may be significant but there is little that can be done to allow for temperature variation in service. The shorter the wire span, the lesser the effect will be.
8. Stainless steel wire with a lay of 1×19 has the greatest elastic modulus and will take up the same load with less extension than equivalent wires with other lays.
9. Sharp ends of wires at terminations and swages need to be removed for the safety of children and other people. No wire end should protrude more than half the diameter of the wire from the swage or termination fitting.

SAFE MOVEMENT AND ACCESS

Table 3.9.2.1 WIRE BARRIER CONSTRUCTION – REQUIRED TENSION FOR STAINLESS STEEL HORIZONTAL WIRES

			Clear distance between posts (mm)								
			600	800	900	1000	1200	1500	1800	2000	2500
Wire dia. (mm)	Lay	Wire spacing (mm)	Minimum <i>required</i> tension in Newtons (N)								
2.5	7×7	60	55	190	263	415	478	823	1080	1139	X
		80	382	630	730	824	1025	1288	X	X	X
		100	869	1218	1368	X	X	X	X	X	X
2.5	1×19	60	35	218	310	402	585	810	1125	1325	X
		80	420	630	735	840	1050	1400	1750	X	X
		100	1140	1565	X	X	X	X	X	X	X
3.0	7×7	60	15	178	270	314	506	660	965	1168	1491
		80	250	413	500	741	818	1083	1370	1565	X
		100	865	1278	1390	1639	X	X	X	X	X
3.0	1×19	60	25	183	261	340	520	790	1025	1180	X
		80	325	555	670	785	1015	1330	1725	1980	X
		100	1090	1500	1705	1910	X	X	X	X	X
4.0	7×7	60	5	73	97	122	235	440	664	813	1178
		80	196	422	480	524	760	1100	1358	1530	2130
		100	835	1182	1360	1528	1837	2381	2811	3098	X
4.0	1×19	60	5	5	10	15	20	147	593	890	1280
		80	30	192	300	415	593	1105	1303	1435	1844
		100	853	1308	1487	1610	2048	2608	3094	3418	3849
4.0	7×19	60	155	290	358	425	599	860	1080	1285	1540
		80	394	654	785	915	1143	1485	1860	2105	2615
		100	1038	1412	1598	1785	2165	2735	X	X	X

Notes:

- Lay = number of strands by the number of individual wires in each strand. For example a lay of 7×19 consists of 7 strands with 19 individual wires in each strand.
- Where a change of direction is made in a run of wire, the tensioning device is to be placed at the end of the longest span.
- If a 3.2 mm wire is used the tension figures for 3.0 mm wire are applied.
- This table may also be used for a set of non-continuous (single) vertical wires forming a barrier using the appropriate clear distance between posts as the vertical clear distance between the rails.
- X = Not allowed because the required tension would exceed the safe load of the wire.

SAFE MOVEMENT AND ACCESS

Table 3.9.2.1 WIRE BARRIER CONSTRUCTION – REQUIRED TENSION FOR STAINLESS STEEL HORIZONTAL WIRES — continued

6. Tension measured with a strain indicator.

Table 3.9.2.2 CONTINUOUS WIRE BARRIER CONSTRUCTION – REQUIRED TENSION FOR VERTICAL OR NEAR VERTICAL STAINLESS STEEL WIRES

Wire dia. (mm)	Lay	Widest spacing between wires (mm)	Maximum clear spacing between rails (mm)
			900
			<i>Required</i> tension in Newtons (N)
2.5	7×19	80	145
		100	310
		110	610
2.5	7×7	80	130
		100	280
		110	500

Notes:

- Lay = number of strands by the number of individual wires in each strand. For example a lay of 7×19 consists of 7 strands with 19 individual wires in each strand.
- Vertical wires require two pulley blocks to each 180° change of direction in the wire.
- Near vertical wires may only require one pulley block for each change of direction.
- Tension measured with a strain indicator.
- The table only includes 7×7 and 7×19 wires due to other wires not having sufficient flexibility to make the necessary turns.

Table 3.9.2.3 WIRE BARRIER CONSTRUCTION – MAXIMUM PERMISSIBLE DEFLECTION FOR STAINLESS STEEL WIRES

		Clear distance between posts(mm)					
		600	900	1200	1500	1800	2000
Wire dia. (mm)	Wire spacing (mm)	Maximum permissible deflection of each wire in mm when a 2 kg mass is suspended at mid span					
2.5	60	17	11	9	8	8	8
	80	7	5	5	5	X	X
3.0	60	19	13	8	7	7	7
	80	8	6	6	5	5	5
4.0	60	18	12	8	8	7	7
	80	8	6	4	4	4	4

Notes:

- Where a change of direction is made in a run of wire the 2 kg mass must be placed at the middle of the longest span.

SAFE MOVEMENT AND ACCESS

Table 3.9.2.3 WIRE BARRIER CONSTRUCTION – MAXIMUM PERMISSIBLE DEFLECTION FOR STAINLESS STEEL WIRES – continued

2. If a 3.2 mm wire is used the deflection figures for 3.0 mm wire are applied.
3. This table may also be used for a set of non-continuous (single) vertical wires forming a barrier using the appropriate clear distance between posts as the vertical clear distance between the rails. The deflection (offset) is measured by hooking a standard spring scale to the mid span of each wire and pulling it horizontally until a force of 19.6 N is applied.
4. X = Not allowed because the *required* tension would exceed the safe load of the wire.
5. This table has been limited to 60 mm and 80 mm spaces for 2.5 mm, 3 mm and 4 mm diameter wires because the *required* wire tensions at greater spacings would require the tension to be beyond the wire safe load limit, or the allowed deflection would be impractical to measure.

(g) A glass barrier must comply with AS 1288.

Figure 3.9.2.1

BARRIER CONSTRUCTION

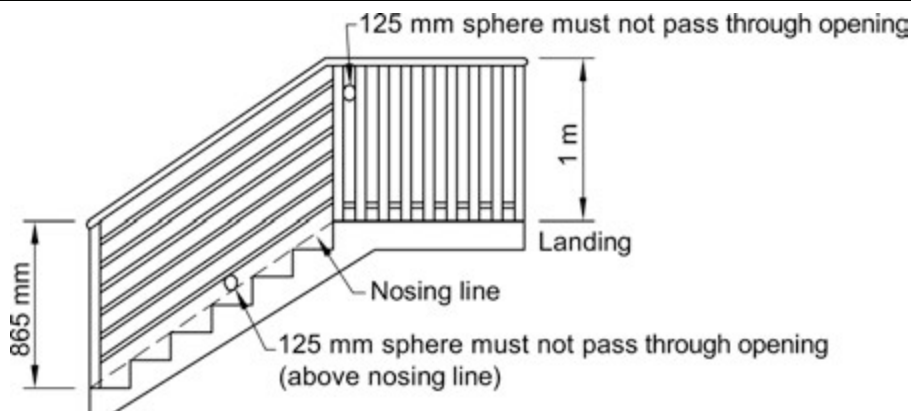

Note: For the purposes of this Figure, a 125 mm sphere must not pass between rails or through the opening when measured above the nosing line.

SAFE MOVEMENT AND ACCESS

Figure 3.9.2.2

TRANSITION ZONES

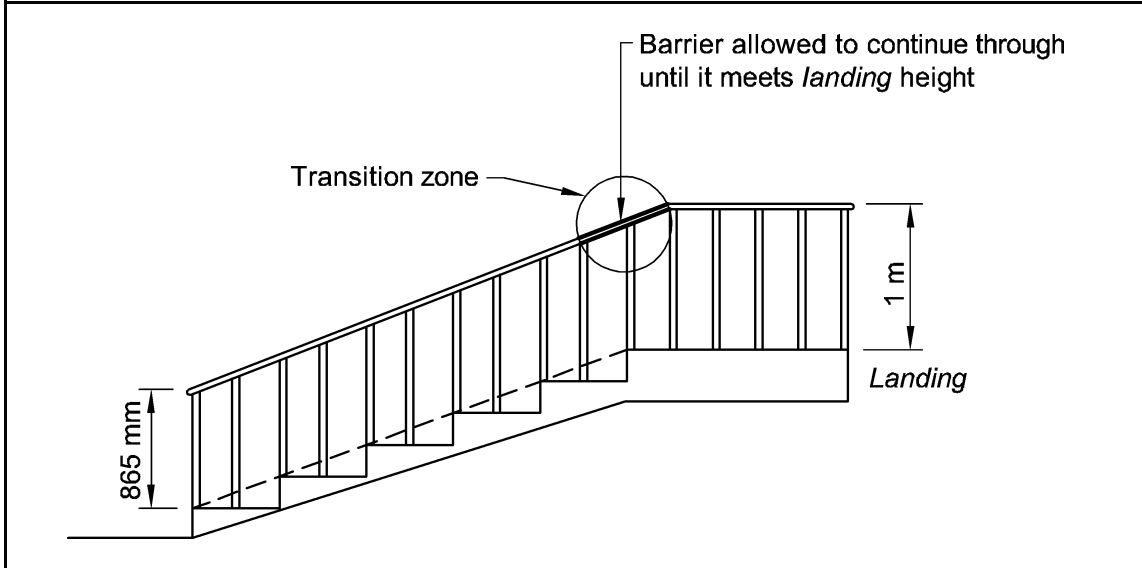
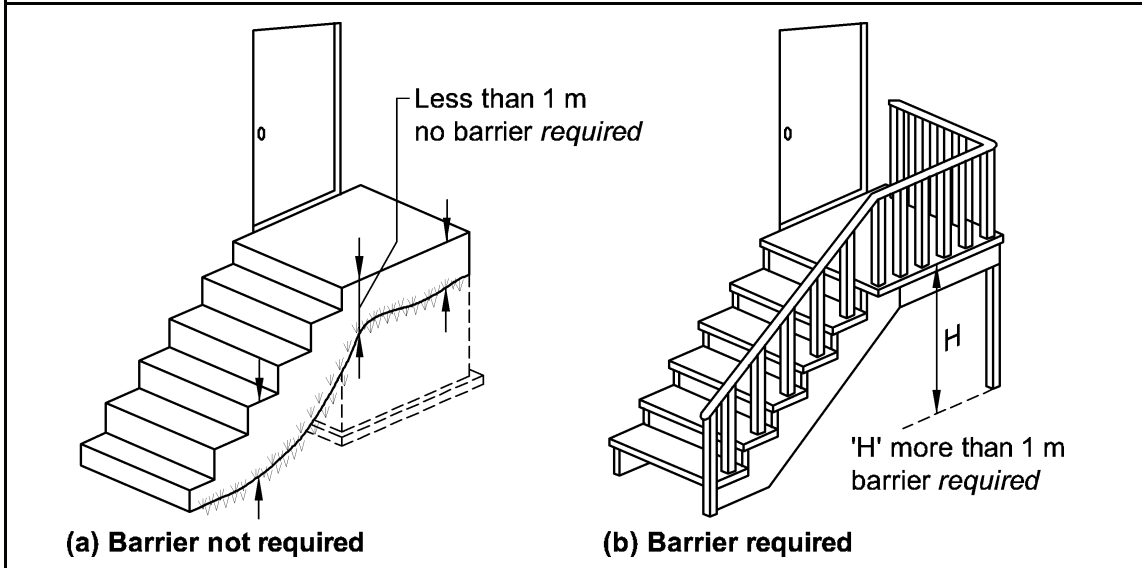

Figure 3.9.2.3

BARRIERS — WHEN REQUIRED



3.9.2.4 Handrails

- (a) Handrails to a stairway or ramp must—
- (i) be located along at least one side of the *flight* or ramp; and
 - (ii) be located along the full length of the *flight* or ramp, except in the case where a handrail is associated with a barrier the handrail may terminate where the barrier terminates; and

SAFE MOVEMENT AND ACCESS

- (iii) have the top surface of the handrail not less than 865 mm vertically above the nosings of the stair treads or the floor surface of the ramp; and
 - (iv) have no obstruction on or above them that will tend to break a handhold, except for newel posts, ball type stanchions, or the like.
- (b) The requirements of (a) do not apply to—
- (i) areas referred to in 3.9.1.2(b); or
 - (ii) a stairway or ramp providing a change in elevation of less than 1 m; or
 - (iii) a landing; or
 - (iv) a winder where a newel post is installed to provide a handhold; or
 - (v) a stairway or ramp in a Class 10 building.

Explanatory Information:

1. A barrier top rail may be suitable as a handrail if it meets 3.9.2.4.
2. A handrail is only *required* on one side of the *flight* or ramp.
3. The handrail may extend the full length of the *flight* or ramp except where the handrail is associated with the barrier, in which case the handrail can terminate where the barrier is allowed to terminate. This would allow for the barriers of geometric stairways such as elliptical, spiral, circular or curved stairways to finish a few treads from the bottom of the stairway.
4. An example of where a handrail is not *required* would be a *flight* consisting of 5 *risers* as the change in elevation is less than 1 m.
5. A handrail is not *required* for winders if a newel post is installed to provide a handhold.

3.9.2.5 Protection of openable windows

- (a) A window opening must be provided with protection, if the floor below the window in a bedroom is 2 m or more above the surface beneath.
- (b) Where the lowest level of the window opening is less than 1.7 m above the floor, a window opening covered by (a) must comply with the following:
- (i) The openable portion of the window must be protected with—
 - (A) a device capable of restricting the window opening; or
 - (B) a screen with secure fittings.
 - (ii) A device or screen *required* by (i) must—
 - (A) not permit a 125 mm sphere to pass through the window opening or screen; and
 - (B) resist an outward horizontal action of 250 N against the—
 - (aa) window restrained by a device; or
 - (bb) screen protecting the opening; and
 - (C) have a child resistant release mechanism if the screen or device is able to be removed, unlocked or overridden.
- (c) A barrier with a height not less than 865 mm above the floor is *required* to an openable window—

SAFE MOVEMENT AND ACCESS

- (i) in addition to window protection, when a child resistant release mechanism is *required* by (b)(ii)(C); and
 - (ii) where the floor below the window is 4 m or more above the surface beneath if the window is not covered by (a).
- (d) A barrier covered by (c) must not—
- (i) permit a 125 mm sphere to pass through it; and
 - (ii) have any horizontal or near horizontal elements between 150 mm and 760 mm above the floor that facilitate climbing.

Explanatory information:

The intent of 3.9.2.5 is to limit the risk of a person (especially a young child) falling through an openable window. Where the floor level below an openable window is less than 2 m there are no specific requirements. For an openable window in a bedroom 2 m or more above the surface beneath, openable windows are *required* to restrict passage of a 125 mm sphere using any one of the following design solutions:

1. The window be designed such that any opening does not allow a 125 mm sphere to pass through (e.g. louvres).
2. The window be fitted with a fixed or dynamic device that is capable of restricting the window opening so it does not allow a 125 mm sphere to pass through and is difficult for a young child to operate. The restricting device must be capable of restricting a 250 N force when directed against the window such as a casement window or in attempting to push a sliding window open. An internal screen with similar parameters may be installed.
3. The window be fitted with an internal or external screen that does not allow a 125 mm sphere to pass through and which must resist a horizontal outward force of 250 N.

If the openable part of the window is at least 1.7 m above the floor, no further protection is *required*.

3.9.2.5(b)(ii)(C) relates to a screen or window restricting device protecting an openable window in a bedroom. The screen or opening restricting device may be installed in a manner that allows it to be removed, unlocked or overridden in the event of a fire or other emergency to allow safe egress. In these situations the unlocking device must be child resistant.

Child resistance could be achieved by the need to use a tool, key or two hands.

There are a number of hardware options available. Short chain winders and barrier screens will allow windows to comply with this requirement. Sliding window locks may lock a sash so a 125 mm sphere cannot pass through. Where provision is made to fully open the window beyond 125 mm then the child resistant release mechanism is *required* in addition to the device resisting a 250 N force as *required* by 3.9.2.5(b)(ii)(B).

3.9.2.5(c) in addition prescribes that an 865 mm barrier (sill) would be *required*. A wall beneath an openable window can be considered as the barrier if the criteria in (d) are met.

3.9.2.5(c)(ii) relates to the height of a barrier under an openable window in a room that is not a bedroom in a Class 1 building or a window in a Class 10 building.

The term 'window' is not italicised in 3.9.2.5 and as such, is not restricted to the definition of 'window' in the BCA. The reason for this is to also capture windows that may let in air but not light, e.g. metal louvres. A metal louvre or openable panel would not fit in the BCA definition of window but is subject to the window barrier provisions.

PART 3.9.3 SWIMMING POOL ACCESS

Appropriate *Performance Requirements*:

Where an alternative *swimming pool* safety barrier is proposed as an *Alternative Solution* to that described in **Part 3.9.3**, that proposal must comply with—

- (a) *Performance Requirement P2.5.3*; and
- (b) the relevant *Performance Requirements* determined in accordance with **1.0.10**.

STATE AND TERRITORY VARIATIONS

1. Part 3.9.3 applies in New South Wales to the technical construction requirements for barriers to restrict access to swimming pools, subject to out-of-ground pool walls and the walls of above ground pools, including inflatable pools, not being considered to be effective barriers.

Note: The Swimming Pools Act 1992 and the Swimming Pools Regulation 2008, applicable to swimming pools with a depth of water of more than 300 mm, regulate the circumstances in which a barrier is required and prevail in the case of any inconsistency.

2. Part 3.9.3 does not apply in Queensland.

Note: Restriction of access to swimming pools in Queensland is regulated under the Building Act 1975.

3. Part 3.9.3 does not apply in the Northern Territory.

4. Part 3.9.3 does not apply in Western Australia.

Note: The restriction of access to private *swimming pools* is regulated under the Building Act 2011 and the Building Regulations 2012.

A. Acceptable construction manuals

3.9.3.0

Performance Requirement P2.5.3 is satisfied for a *swimming pool* associated with a Class 1 building, with a depth of water more than 300 mm if it has safety barriers installed in accordance with AS 1926 Parts 1 and 2.

PART 3.9.4 SWIMMING POOL WATER RECIRCULATION SYSTEMS

Appropriate *Performance Requirements*:

Where an alternative *swimming pool* water recirculation system is proposed as an *Alternative Solution* to that described in **Part 3.9.4**, that proposal must comply with—

- (a) *Performance Requirement P2.5.4*; and
- (b) the relevant *Performance Requirements* determined in accordance with **1.0.10**.

A. Acceptable construction manual

3.9.4.0

Performance Requirement P2.5.4 is satisfied for a *swimming pool* with a depth of water more than 300 mm if it complies with AS 1926.3.

Explanatory information:

The requirements for water recirculation systems in *swimming pools* make provisions for the safety of users by means of minimising the risk of entrapment or injury of people using the pool and provide for the safe operation of skimmer boxes and outlet systems.

The BCA definition of *swimming pool* is specific in including a bathing or wading pool and a spa. Therefore, the *Deemed-to-Satisfy Provision*, if chosen as the *Building Solution*, applies the requirements of AS 1926.3 to all types of pools defined as *swimming pools* under the BCA, irrespective of the definition of *swimming pool* stated in the Standard.

PART **3.10**

**ADDITIONAL CONSTRUCTION
REQUIREMENTS**

3.10.1 High Wind Areas

3.10.2 Earthquake Areas

3.10.3 Flood Hazard Areas

PART 3.10 CONTENTS

PART 3.10 ADDITIONAL CONSTRUCTION REQUIREMENTS

Explanatory Information

3.10.1 High Wind Areas

3.10.1.0 Acceptable construction manuals

3.10.2 Earthquake Areas

3.10.2.0 Acceptable construction manuals

3.10.3 Flood Hazard Areas

3.10.3.0 Acceptable construction manuals

PART 3.10 EXPLANATORY INFORMATION

Explanatory information:

These provisions have been introduced to address design requirements for increased structural loading conditions that may occur due to geographical, topographical or climatic conditions that are beyond the scope of the preceding Parts of the *Housing Provisions*.

These provisions are to be read in conjunction with the other relevant requirements of this code.

PART 3.10.1 HIGH WIND AREAS

Appropriate Performance Requirements:

Where an alternative method of constructing in *high wind areas* is proposed as an *Alternative Solution* to that described in **Part 3.10.1**, that proposal must comply with—

- (a) *Performance Requirement P2.1.1*; and
- (b) the relevant *Performance Requirements* determined in accordance with **1.0.10**.

Acceptable construction manuals

3.10.1.0

Performance Requirement P2.1.1 is satisfied for a building constructed in a *high wind area* if it complies with one or more of the following:

- (a) Masonry:
 - (i) AS 3700.
 - (ii) AS 4773 Parts 1 and 2.
- (b) The Northern Territory Deemed-to-Comply Standards Manual.
- (c) Timber:
 - (i) * * * * *
 - (ii) * * * * *
 - (iii) AS 1684.2.
 - (iv) AS 1684.3.
- (d) Steel:
 - (i) * * * * *
 - (ii) Steel framing: AS 4100.
 - (iii) Cold-formed steel structures: AS 4600.
 - (iv) Residential and low-rise steel framing: NASH Standard 'Residential and Low-Rise Steel Framing' Part 1 or Part 2.
- (e) Glazed assemblies:
 - (i) AS 2047 for the following glazed assemblies in an *external wall*:
 - (A) *Windows* excluding those listed in (ii).
 - (B) Sliding and swinging doors with a frame, including french and bi-fold doors with a frame.
 - (C) Adjustable louvres.

ADDITIONAL CONSTRUCTION REQUIREMENTS

- (D) Window walls with one piece framing.
- (ii) AS 1288 for all glazed assemblies not covered by (i) and the following glazed assemblies:
- (A) All glazed assemblies not in an *external wall*.
 - (B) Revolving doors.
 - (C) Fixed louvres.
 - (D) Skylights, roof lights and *windows* in other than the vertical plane.
 - (E) Sliding and swinging doors without a frame.
 - (F) *Windows* constructed on site and architectural one-off *windows*, which are not design tested in accordance with AS 2047.
 - (G) Second-hand *windows*, re-used *windows* and recycled *windows*.
 - (H) Heritage *windows*.
 - (I) Timber *windows* in wind classification N3 or C1.
 - (J) Glazing used in balustrades and sloping overhead glazing.
- (f) In cyclonic areas, metal roof assemblies, their connections and immediate supporting members must be capable of remaining in position notwithstanding any permanent distortion, fracture or damage that might occur in the sheet or fastenings under the pressure sequences A to G defined in **Table 3.10.1**.

Table 3.10.1 Low-High-Low pressure sequence

Sequence	Number of cycles	Load
A	4500	0 to 0.45 Pt
B	600	0 to 0.6 Pt
C	80	0 to 0.8 Pt
D	1	0 to 1.0 Pt
E	80	0 to 0.8 Pt
F	600	0 to 0.6 Pt
G	4500	0 to 0.45 Pt

Notes:

1. Pt is the ultimate limit state wind pressure on internal and external surfaces as determined in accordance with AS/NZS 1170.2, modified by an appropriate factor for variability, as determined in accordance with Table B1 of AS/NZS 1170.0.
 2. The rate of load cycling must be less than 3Hz.
 3. The single load cycle (sequence D) must be held for a minimum of 10 seconds.
- (g) For the purposes of (f), cyclonic areas are those determined as being located in wind regions C and D in accordance with **Figure 3.10.1.4**.

ADDITIONAL CONSTRUCTION REQUIREMENTS

Explanatory information:

The requirements of **3.10.1.0(f)** must be read in conjunction with the provisions of AS/NZS 1170.2. The ABCB commissioned research to establish a national consistent testing regime for metal roof cladding assemblies in cyclonic areas. The results of this research are contained in **3.10.1.0(f)**.

Low cycle fatigue cracking of metal roof cladding elements during tropical cyclones is a complex process where small changes in load, geometry or material properties can significantly affect the fatigue performance of the cladding system (includes immediate supports, fixings and cladding). The consequences of failure of an element can quickly lead to more elements progressively failing. These failed elements become wind driven debris and so pose a threat to people and other structures as potential missiles.

The fatigue loading sequence defined in **Table 3.10.1** is to simulate the wind load induced by a cyclonic event. In order to have a repeatable standard test that can be performed by different testing laboratories within a reasonable time frame on different types of test equipment, the loading sequence is a simplification of the dynamic wind loading environment. In the formulation of the fatigue loading sequence assumptions such as cyclone counts, load range, cyclone duration, wind direction change, building orientation and building geometry have been made.

If a system does not successfully resist the fatigue loading sequence in **Table 3.10.1**, it does not comply.

The test section consists of cladding elements, fastenings and immediate supporting members assembled together in a manner identical to those parts of the particular roof which the test section is intended to replicate.

STATE AND TERRITORY VARIATIONS

Add 3.10.1.0(h) in the Northern Territory.

- (h) Masonry veneer — Masonry veneer construction must be designed so that the structural framing to which the masonry veneer is tied will ensure the stability of the masonry veneer.

ADDITIONAL CONSTRUCTION REQUIREMENTS

Figure 3.10.1.4
WIND REGIONS

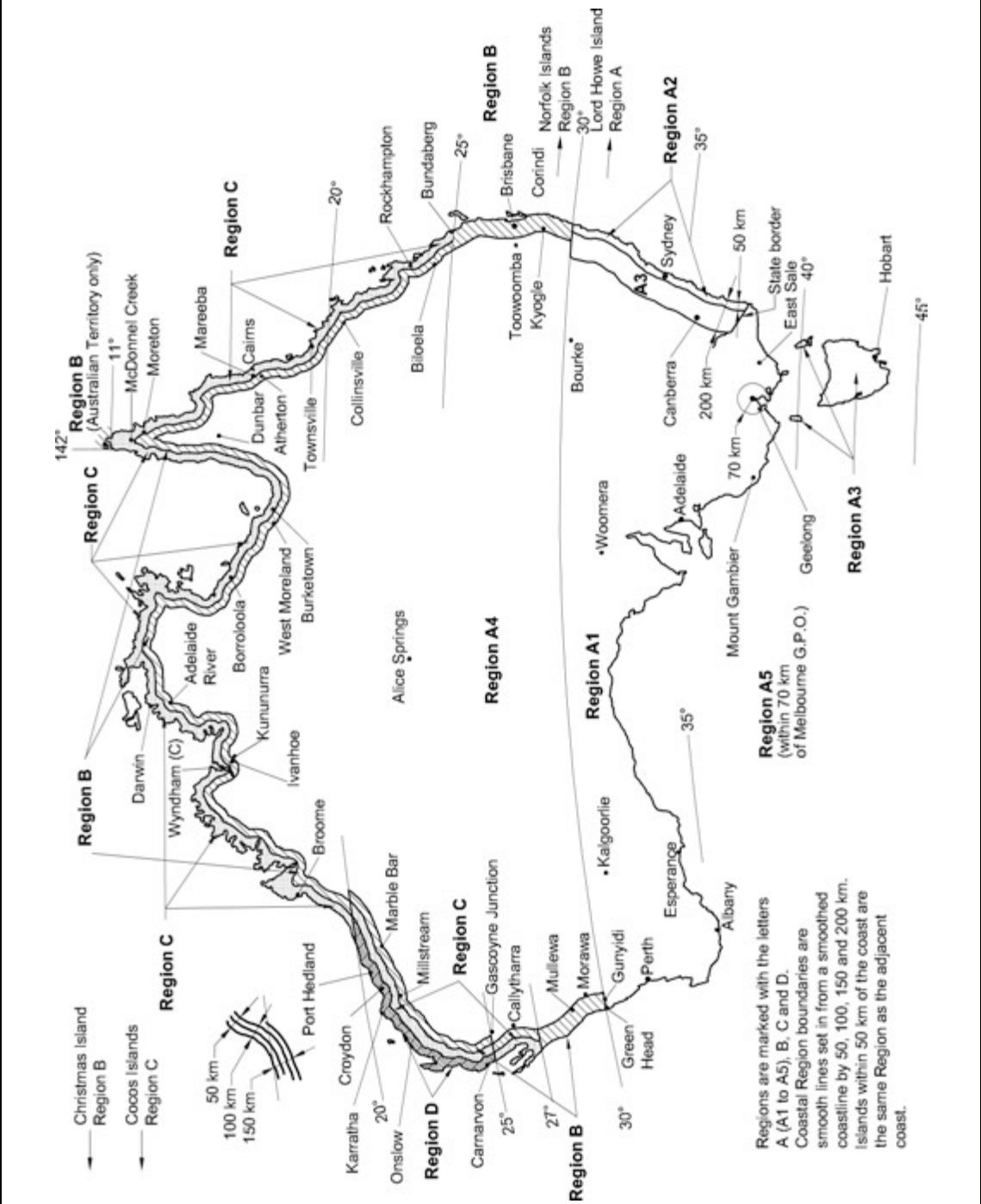

Note: *High wind areas* exist outside the wind regions indicated on this map.

ADDITIONAL CONSTRUCTION REQUIREMENTS

Explanatory information:

Construction in *high wind areas*

The intent of building construction in *high wind areas* is to ensure the structure has sufficient strength to transfer wind forces to the ground with an adequate safety margin to prevent the collapse of the building and the building being lifted, or slid off its foundations.

To resist these forces it is necessary to have—

- (a) an anchorage system, where the roof is connected by the walls to the footings by a chain of connections; and
- (b) a bracing system to prevent horizontal collapse due to wind forces; and
- (c) continuity of the system where each structural element is interlocked to its adjoining structural element throughout the building.

Anchorage

Anchorage of the system is achieved by using a variety of proprietary connectors. Each connector must be capable of carrying the uplift force, because the ability of the building to resist the wind forces is directly related to its weakest link.

Acceptable construction manuals to achieve these requirements are described in this Part.

PART 3.10.2 EARTHQUAKE AREAS

Appropriate *Performance Requirements*:

Where an alternative design is proposed as an *Alternative Solution* to that described in **Part 3.10.2**, that proposal must comply with—

- (a) *Performance Requirement P2.1.1*; and
- (b) the relevant *Performance Requirements* determined in accordance with **1.0.10**.

A. Acceptable construction manuals

3.10.2.0

Performance Requirement P2.1.1 for Class 1 and 10 buildings constructed in areas subject to seismic activity is satisfied if the building is constructed in accordance with the acceptable construction manuals listed in **Part 3.11**.

Explanatory information:

1. Most domestic structures are not *required* to be specifically designed for earthquakes, because the construction system already in place for wind resistance is usually adequate for earthquake resistance.
2. There are certain limitations on the application to domestic structures such as Class 1a and 1b buildings in Appendix A of AS 1170.4. These limitations include building height, roof slope, etc. For additional information refer to Appendix A of AS 1170.4.

PART 3.10.3 FLOOD HAZARD AREAS

Appropriate Performance Requirements:

Where an alternative design is proposed as an *Alternative Solution* to that described in **Part 3.10.3**, that proposal must comply with—

- (a) *Performance Requirement P2.1.2*; and
- (b) the relevant *Performance Requirements* determined in accordance with **1.0.10**.

STATE AND TERRITORY VARIATIONS

In South Australia **Part 3.10.3** does not apply.

Acceptable construction manual

3.10.3.0

Performance Requirement P2.1.2 for Class 1 buildings constructed in a *flood hazard area* is satisfied if the building is constructed in accordance with the ABCB Standard for Construction of Buildings in Flood Hazard Areas.

STATE AND TERRITORY VARIATIONS

3.10.3.0 does not apply in Queensland.

Note: Building work in designated *flood hazard areas* is regulated by the Building Act 1975 and the Queensland Development Code 3.5 - Construction of buildings in flood hazard areas.

In Victoria 3.10.3.0 is replaced as follows:

- (a) *Performance Requirement P2.1.2* for Class 1 buildings constructed in a *flood hazard area* is satisfied if the building is constructed in accordance with the ABCB Standard for Construction of Buildings in Flood Hazard Areas.
- (b) The definitions of *flood hazard area* and *freeboard* in the ABCB Standard for Construction of Buildings in Flood Hazard Areas are replaced with those in the Victorian variations to **1.1.1.2**.
- (c) The definition of *defined flood level* in the ABCB Standard for Construction of Buildings in Flood Hazard Areas is replaced with that in **1.1.1.2**.

PART **3.11**

**STRUCTURAL DESIGN
MANUALS**

3.11 Structural Design Manuals

PART 3.11 CONTENTS

PART 3.11 STRUCTURAL DESIGN MANUALS

Explanatory Information

3.11 Structural design manuals

3.11.1 Application

3.11.2 Resistance to actions

3.11.3 Determination of individual actions

3.11.4 * * * * *

3.11.5 * * * * *

3.11.6 Determination of structural resistance of materials and forms of construction

PART 3.11 EXPLANATORY INFORMATION

Explanatory information:

This Part of the *Housing Provisions* contains a list of deemed-to-satisfy codes (structural design manuals) that can be used to design building elements using engineering principles.

These provisions can be used in conjunction with both the *Performance Requirements* (listed in Section 2) and the *Deemed-to-Satisfy Provisions* (listed in Section 3 — Parts 1 to 12). This combined approach is acceptable and meets the requirements of the *Housing Provisions*.

PART 3.11 STRUCTURAL DESIGN MANUALS

Appropriate *Performance Requirements*:

Where it is proposed to use an alternative structural design manual as an *Alternative Solution* to that described in **Part 3.11**, that proposal must comply with—

- (a) *Performance Requirement P2.1.1*; and
- (b) the relevant *Performance Requirements* determined in accordance with **1.0.10**.

Acceptable construction manuals

3.11.1 Application

Performance Requirement P2.1.1 is satisfied by complying with—

- (a) **3.11.2**, **3.11.3** and **3.11.6**; or
- (b) the relevant provisions of other Parts of Section 3 of the *Housing Provisions* relating to structural elements; or
- (c) any combination thereof.

3.11.2 Resistance to actions

The resistance of a building or structure must be greater than the most critical action effect resulting from different combinations of actions, where—

- (a) the most critical action effect on a building or structure must be determined in accordance with **3.11.3** and the general design procedures contained in AS/NZS 1170.0; and
- (b) the resistance of a building or structure must be determined in accordance with **3.11.6**.

3.11.3 Determination of individual actions

The magnitude of individual actions must be determined in accordance with the following:

- (a) Permanent actions:
 - (i) the design or known dimensions of the building or structure; and
 - (ii) the unit weight of the construction; and
 - (iii) AS/NZS 1170.1.
- (b) Imposed actions:
 - (i) the known loads that will be imposed during the occupation or use of the building or structure; and
 - (ii) *construction activity actions*; and
 - (iii) AS/NZS 1170.1.

STRUCTURAL DESIGN MANUALS

- (c) Wind, snow and earthquake actions:
- (i) the applicable annual probability of design event for safety, determined by—
 - (A) assigning the building or structure an Importance Level in accordance with [Table 3.11.3a](#); and
 - (B) determining the corresponding annual probability of exceedance for safety in accordance with [Table 3.11.3b](#); and
 - (ii) for wind actions, AS/NZS 1170.2 or AS 4055; and
 - (iii) for snow and ice actions, AS/NZS 1170.3; and
 - (iv) for earthquake actions, AS 1170.4.
- (d) In cyclonic areas, metal roof cladding, their connections and immediate supporting members must be capable of remaining in position notwithstanding any permanent distortion, fracture or damage that might occur in the sheet or fastenings under the pressure sequences A to G defined in [Table 3.10.1](#).
- (e) For the purposes of (d), cyclonic areas are those determined as being located in wind regions C and D in accordance with [Figure 3.10.1.4](#).
- (f) Action not covered in (a), (b) and (c) above:
- (i) the nature of the action; and
 - (ii) the nature of the building or structure; and
 - (iii) the Importance Level of the building or structure determined in accordance with [Table 3.11.3a](#); and
 - (iv) AS/NZS 1170.1.
- (g) For the purposes of (f) the actions include but are not limited to—
- (i) liquid pressure action; and
 - (ii) ground water action; and
 - (iii) rainwater action (including ponding action); and
 - (iv) earth pressure action; and
 - (v) differential movement; and
 - (vi) time dependent effects (including creep and shrinkage); and
 - (vii) thermal effects; and
 - (viii) ground movement caused by—
 - (A) swelling, shrinkage or freezing of the subsoil; and
 - (B) landslip or subsidence; and
 - (C) siteworks associated with the building or structure; and
 - (ix) *construction activity actions*.

STRUCTURAL DESIGN MANUALS

Table 3.11.3a IMPORTANCE LEVELS OF BUILDINGS AND STRUCTURES

Importance Level	Building types
1	Buildings or structures presenting a low degree of hazard to life and <i>other property</i> in the case of failure.
2	Buildings or structures not included in Importance Level 1.

Explanatory information:

Table 3.11.3a provides a generic description of building types to which Importance Levels have been assigned. The "Importance Level" concept is applicable to building structural safety only. More specific examples are provided in the following Table. The examples are indicative and not exhaustive.

Importance Level	Examples of building types
1	Isolated minor Class 10a buildings and Class 10b structures.
2	Class 1 buildings. Class 10a buildings and Class 10b structures associated with Class 1 buildings.

Note: Importance Levels must be assigned on a case by case basis and relate to the hazards to human life and *other property* in the event of the structure's failure. For example—

- (a) Importance Level 1 is for minor isolated structures that rarely contain people, are not required as part of normal infrastructure and present a low risk to life and other property.
- (b) Importance Level 2 includes domestic housing and structures intended to contain reasonable numbers of people under normal operations.

Table 3.11.3b DESIGN EVENTS FOR SAFETY

Importance Level	Annual probability of exceedance			
	Wind		Snow	Earthquake
	Non-cyclonic	Cyclonic		
1	1:100	1:200	1:100	1:250
2	1:500	1:500	1:150	1:500

3.11.4 * * * * *

This clause has deliberately been left blank.

3.11.5 * * * * *

This clause has deliberately been left blank.

3.11.6 Determination of structural resistance of materials and forms of construction

The structural resistance of materials and forms of construction must be determined in accordance with the following:

- (a) Steel construction:
 - (i) Cold-formed steel structures: AS/NZS 4600.
 - (ii) Residential and low-rise steel framing: NASH Standard 'Residential and Low-Rise Steel Framing' Part 1.
 - (iii) Steel structures: AS 4100.
- (b) Aluminium construction:
 - (i) AS/NZS 1664 Part 1.
 - (ii) AS/NZS 1664 Part 2.
- (c) Timber construction:
AS 1720.1.
- (d) Footings:
 - (i) Residential slabs and footings: AS 2870.
 - (ii) Concrete structures: AS 3600.
- (e) Piling:
AS 2159.
- (f) Concrete construction (including reinforced and prestressed concrete):
AS 3600.
- (g) Masonry (including masonry-veneer, *unreinforced masonry* and *reinforced masonry*):
 - (i) AS 3700.
 - (ii) AS 4773 Parts 1 and 2.
- (h) Composite steel and concrete:
AS 2327.1.
- (i) Glazed assemblies:
 - (i) AS 2047 for the following glazed assemblies in an *external wall*:
 - (A) Windows excluding those listed in (ii).
 - (B) Sliding and swinging glazed doors with a frame, including french and bi-fold doors with a frame.
 - (C) Adjustable louvres.
 - (D) Window walls with one piece framing.
 - (ii) AS 1288 for all glazed assemblies not covered by (i) and the following glazed assemblies:
 - (A) All glazed assemblies not in an *external wall*.
 - (B) Revolving doors.

STRUCTURAL DESIGN MANUALS

- (C) Fixed louvres.
 - (D) Skylights, roof lights and windows in other than the vertical plane.
 - (E) Sliding and swinging doors without a frame.
 - (F) Windows constructed on site and architectural one-off windows, which are not design tested in accordance with AS 2047.
 - (G) Second-hand windows, re-used windows and recycled windows.
 - (H) Heritage windows.
 - (I) Glazing used in balustrades and sloping overhead glazing.
- (j) Garage doors and other large access doors in openings not more than 3 m in height in *external walls* of buildings determined as being located in wind region C or D in accordance with **Figure 3.10.1.4**:

AS/NZS 4505.

Explanatory information:

The reference to heritage windows in **3.11.6(i)(ii)(H)** is intended to apply to windows in heritage buildings. The method of determining a heritage building is normally covered by the relevant State or Territory authority.

Explanatory information:

The weight of roof or ceiling insulation, particularly if additional ceiling insulation is used for compliance with the energy efficiency provisions, needs to be considered in the selection of plasterboard, plasterboard fixings and building framing.

PART **3.12**

ENERGY EFFICIENCY

3.12 Energy Efficiency

3.12.1 Building Fabric

3.12.2 External Glazing

3.12.3 Building Sealing

3.12.4 Air Movement

3.12.5 Services

PART 3.12 CONTENTS

PART 3.12 ENERGY EFFICIENCY

3.12 Energy efficiency

3.12 Definitions

3.12.0 Application of Part 3.12

3.12.0.1 Heating and cooling loads

3.12.1 Building fabric

3.12.1 Application

3.12.1.1 Building fabric thermal insulation

3.12.1.2 Roofs

3.12.1.3 Roof lights

3.12.1.4 External walls

3.12.1.5 Floors

3.12.1.6 Attached Class 10a buildings

3.12.2 External Glazing

3.12.2 Application

3.12.2.1 External glazing

3.12.2.2 Shading

3.12.3 Building Sealing

3.12.3 Application

3.12.3.1 Chimneys and flues

3.12.3.2 Roof lights

3.12.3.3 External windows and doors

3.12.3.4 Exhaust fans

3.12.3.5 Construction of roofs, walls and floors

3.12.3.6 Evaporative coolers

3.12.4 Air Movement

3.12.4 Application

3.12.4.1 Air movement

3.12.4.2 Ventilation openings

3.12.4.3 Ceiling fans and evaporative coolers

3.12.5 Services

3.12.5 Application

3.12.5.0 Acceptable construction manual

3.12.5.1 Insulation of services

3.12.5.2 Central heating water piping

3.12.5.3 Heating and cooling ductwork

3.12.5.4 Electric resistance space heating

ENERGY EFFICIENCY

- 3.12.5.5 Artificial lighting
- 3.12.5.6 Water heater in a heated water supply system
- 3.12.5.7 Swimming pool heating and pumping
- 3.12.5.8 Spa pool heating and pumping

PART 3.12 ENERGY EFFICIENCY

Appropriate *Performance Requirements*:

Where an alternative energy efficiency design is proposed as an *Alternative Solution* to that described in **Part 3.12**, that proposal must comply with—

- (a) *Performance Requirement P2.6.1*; and
- (b) *Performance Requirement P2.6.2*; and
- (c) the relevant *Performance Requirements* determined in accordance with **1.0.10**.

STATE AND TERRITORY VARIATIONS

1. In New South Wales, **Part 3.12** does not apply.
Note: The New South Wales Additions contain energy efficiency measures that apply in New South Wales to support and complement BASIX.
2. In the Northern Territory, **Part 3.12** is replaced with BCA 2009 **Part 3.12**.
3. In South Australia, for the purposes of this Part, a sunroom or the like is deemed to be a Class 10a building and must comply with **3.12.1.6**.

Definitions

3.12

The following definitions are used in this Part:

Conditioned space means a space within a building that is heated or cooled by the building's *domestic services*, excluding a non-*habitable room* in which a heater with a capacity of not more than 1.2 kW or 4.3 MJ/hour is installed.

House energy rating software means software accredited under the Nationwide House Energy Rating Scheme and is limited to assessing the potential thermal efficiency of the dwelling envelope.

Explanatory information:

The Nationwide House Energy Rating Scheme (NatHERS) refers to the Australian governments' scheme that facilitates consistent energy ratings from software tools which are used to assess the potential thermal efficiency of dwelling envelopes.

Illumination power density (W/m^2) means the total of the power that will be consumed by the lights in a space, including any lamps, ballasts, current regulators and control devices other than those that are plugged into socket outlets for intermittent use such as floor standing lamps, desk lamps or work station lamps, divided by the area of the space.

ENERGY EFFICIENCY

Explanatory information:

1. *Illumination power density* relates to the power consumed by the lighting system and includes the light source or luminaire and any control device. The power for the lighting system is the illumination power load. This approach is more complicated than the *lamp power density* approach but provides more flexibility for a dwelling with sophisticated control systems.
2. The area of the space refers to the area the lights serve. This could be considered a single room, open plan space, verandah, balcony or the like, or the total area of all these spaces.

Lamp power density (W/m²) means the total of the maximum power rating of the lamps in a space, other than those that are plugged into socket outlets for intermittent use such as floor standing lamps or desk lamps or work station lamps, divided by the area of the space.

Explanatory information:

1. *Lamp power density* is a simple means of setting energy consumption at an efficient level for Class 1 and associated Class 10a buildings.
2. Lamp refers to the globe or globes that are to be installed in a permanently wired light fitting. The maximum power of a lamp is usually marked on the fitting as the maximum allowable wattage.
3. The area of the space refers to the area the lights serve. This could be considered a single room, open plan space, verandah, balcony or the like, or the total area of all these spaces.

Piping means an assembly of pipes, with or without valves or other fittings, connected together for the conveyance of liquids.

R-Value (m².K/W) means the thermal resistance of a component calculated by dividing its thickness by its thermal conductivity.

Reflective insulation means a building membrane with a reflective surface such as a reflective foil laminate, reflective barrier, foil batt or the like capable of reducing radiant heat flow.

Explanatory information:

1. Typical *R-values* achieved by adding *reflective insulation* are given in the explanatory information accompanying **Figures 3.12.1.1, 3.12.1.3 and 3.12.1.4**. Information on specific products may be obtained from *reflective insulation* manufacturers.
2. The surface of *reflective insulation* may be described in terms of its emittance (or infrared emittance) or in terms of its reflectance (or solar reflectance). Generally, for the surface of a particular *reflective insulation* –
emittance + reflectance = 1
3. Some types of *reflective insulation* may also serve the purposes of waterproofing or vapour proofing.

Total System Solar Heat Gain Coefficient (SHGC) means the fraction of incident irradiance on *glazing* or a *roof light* that adds heat to a building's space.

Total R-Value means the sum of the *R-Values* of the individual component layers in a composite element including any building material, insulation material, airspace and associated surface resistances.

ENERGY EFFICIENCY

Total System U-Value (W/m².K) means the thermal transmittance of the composite element allowing for the effect of any airspace and associated surface resistances.

Ventilation opening means an opening in the *external wall*, floor or roof of a building designed to allow air movement into or out of the building by natural means including a permanent opening, an openable part of a *window*, a door or other device which can be held open.

Acceptable construction practice

3.12.0 Application of Part 3.12

- (a) *Performance Requirement P2.6.1* for the thermal performance of the building is satisfied by—
- (i) complying with—
 - (A) **3.12.0.1**, for reducing the heating or cooling loads; and
 - (B) **3.12.1.1**, for building *fabric* thermal insulation; and
 - (C) **3.12.1.2(c)** and **3.12.1.4(b)**, for thermal breaks; and
 - (D) **3.12.1.2(e)**, for compensating for a loss of ceiling insulation; and
 - (E) **3.12.1.5(c)** and **3.12.1.5(d)**, for floor edge insulation; and
 - (F) **Part 3.12.3**, for building sealing; or
 - (ii) complying with—
 - (A) **Part 3.12.1**, for the building *fabric*; and
 - (B) **Part 3.12.2**, for the external *glazing* and shading; and
 - (C) **Part 3.12.3**, for building sealing; and
 - (D) **Part 3.12.4**, for air movement.

STATE AND TERRITORY VARIATION

3.12.0(a) is replaced in Victoria as follows:

- (a) *Performance Requirement P2.6.1* for the thermal performance of the building is satisfied by—
- (i) complying with—
 - (A) **3.12.0.1**, for reducing the heating or cooling loads; and
 - (B) **3.12.1.1**, for building *fabric* thermal insulation; and
 - (C) **3.12.1.2(c)** and **3.12.1.4(b)**, for thermal breaks; and
 - (D) **3.12.1.2(e)**, for compensating for a loss of ceiling insulation; and
 - (E) **3.12.1.5(c)** and **3.12.1.5(d)**, for floor edge insulation; and
 - (F) **Part 3.12.3**, for building sealing; and

ENERGY EFFICIENCY

in the case of a new Class 1 building, having either a rainwater tank connected to all sanitary flushing systems, or a solar water heater system, installed in accordance with the Plumbing Regulations 2008; or

(ii) complying with—

- (A) **Part 3.12.1**, for the building *fabric*; and
- (B) **Part 3.12.2**, for the external *glazing* and shading; and
- (C) **Part 3.12.3**, for building sealing; and
- (D) **Part 3.12.4**, for air movement; and

in the case of a new Class 1 building, having either a rainwater tank connected to all sanitary flushing systems, or a solar water heater system, installed in accordance with the Plumbing Regulations 2008.

- (b) *Performance Requirement P2.6.2* for reducing greenhouse gas emissions is satisfied by complying with **Part 3.12.5**.

Explanatory information:

There are two options for complying with the energy efficiency *Deemed-to-Satisfy Provisions* **3.12.1** to **3.12.4**:

Option 1 Energy Rating — **3.12.0(a)(i)** to achieve the *required* energy rating and comply with **(B)** to **(F)** for energy-saving features such as the testing and installation of insulation, thermal breaks, compensation for downlights, floor edge insulation and detailed provisions for building sealing.

Option 2 Elemental Provisions — **3.12.0(a)(ii)** to satisfy all the detailed provisions including meeting the *Total R-Values* of roofs, walls and floors, the *glazing* allowances and the air movement requirements. These detailed provisions also include the testing and installation of insulation, thermal breaks, compensation for downlights, floor edge insulation and detailed provisions for building sealing.

This is explained in the flow chart.

ENERGY EFFICIENCY

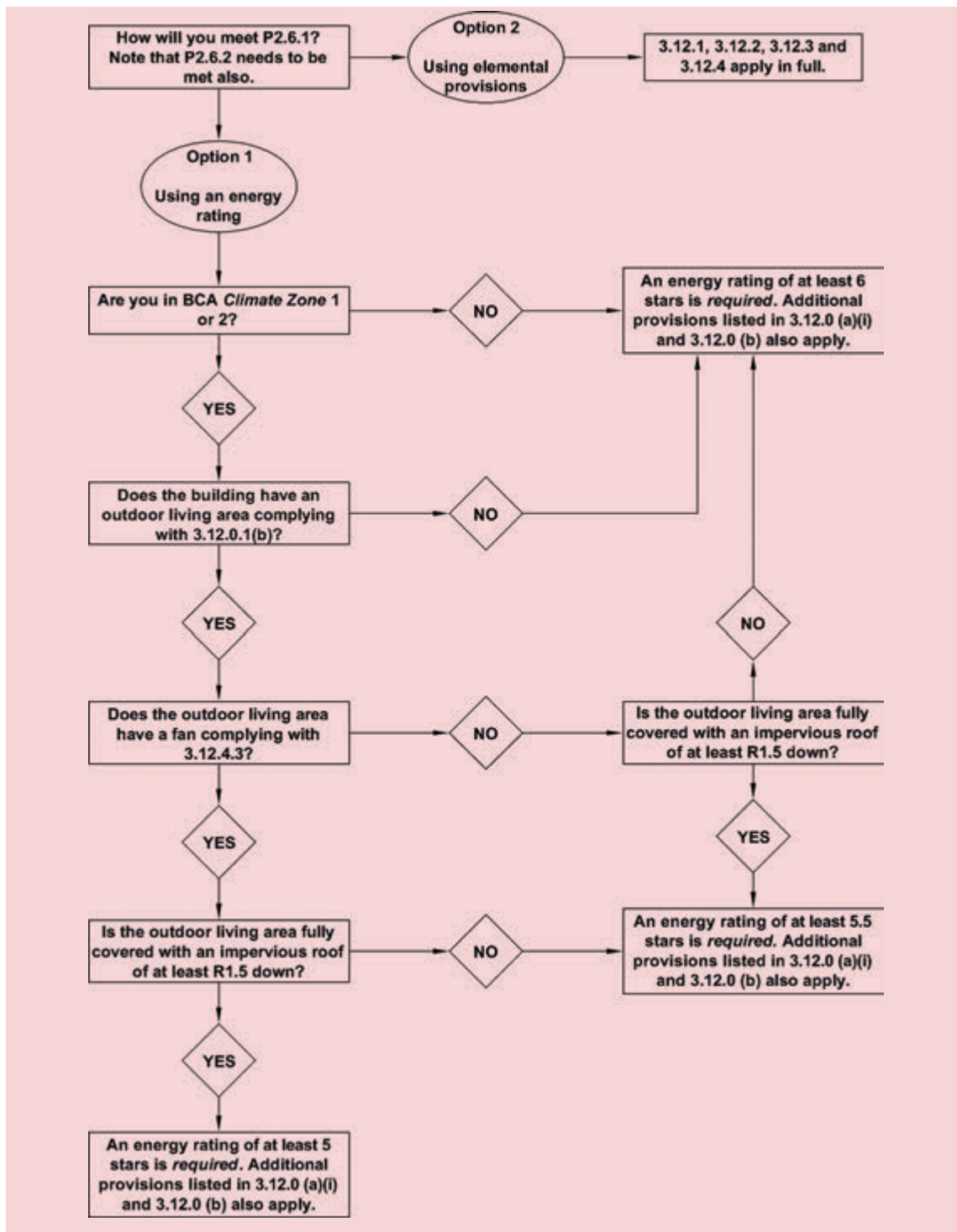

ENERGY EFFICIENCY

3.12.0.1 Heating and cooling loads

- (a) To reduce heating or cooling loads, a building must achieve an energy rating using *house energy rating software*, of not less than—
- (i) 6 stars; or
 - (ii) for a building in *climate zones* 1 or 2, 5.5 stars if the building has an outdoor living area as described in (b) if the outdoor living area—
 - (A) is fully covered with an impervious roof having a *Total R-Value* of at least 1.5 (for downward heat flow); or
 - (B) has at least one permanently installed ceiling fan; or
 - (iii) for a building in *climate zones* 1 or 2, 5 stars if the building has an outdoor living area as described in (b) if the outdoor living area—
 - (A) is fully covered with an impervious roof having a *Total R-Value* of at least 1.5 (for downward heat flow); and
 - (B) has at least one permanently installed ceiling fan.

Explanatory information:

1. To comply with (a)(ii), either insulate the roof of the outdoor living area, or provide a ceiling fan.
2. To comply with (a)(iii), insulate the roof of the outdoor living area and provide a ceiling fan.

STATE AND TERRITORY VARIATION**In South Australia delete 3.12.0.1(a) and insert SA 3.12.0.1(a) as follows:**

- (a) To reduce heating and cooling loads, a building must—
- (i) achieve an energy rating using *house energy rating software* of not less than 6 stars; or
 - (ii) for an elevated building with a lightweight flooring system that has a *floor area* not more than 60 m² – achieve an energy rating using *house energy rating software* of not less than 5 stars; or
 - (iii) for an elevated building with a lightweight flooring system located in areas listed in (b) – achieve an energy rating using *house energy rating software* of not less than 5 stars and comply with Minister's Specification SA 3.12.0.1(a).
- (b) The areas where the requirements of (iii) apply are—
- (i) *climate zone* 4; and
 - (ii) one of the following local government areas—
 - Ceduna Council
 - Cleve Council
 - The Coorong District Council
 - Elliston Council
 - Flinders Ranges Council

ENERGY EFFICIENCY

Franklin Harbour Council
 Goyder Council
 Kangaroo Island Council
 Karoonda East Murray Council
 Kimba Council
 Lower Eyre Peninsula Council
 Mid Murray Council
 Mount Remarkable Council
 Orroroo Carrieton Council
 Peterborough Council
 Southern Mallee Council
 Streaky Bay Council
 Tatiara Council
 Tumby Bay Council
 Wudinna Council; and

(iii) land not within a local government council area.

- (b) An outdoor living area in (a)(ii) and (a)(iii) is a space that—
- (i) is directly adjoining, and directly accessible from, a general purpose living area of a Class 1 building such as a lounge, kitchen, dining or family room, which is not a room for sleeping or specialist tasks such as a study or home theatre; and
 - (ii) has a *floor area* of not less than 12.0 m²; and
 - (iii) has length and width dimensions of not less than 2.5 m each; and
 - (iv) has an opening height above floor level of not less than 2.1 m; and
 - (v) has one side permanently open with a second side either—
 - (A) permanently open; or
 - (B) readily openable.
- (c) The sides referred to in (b)(v) must be not less than 900 mm from an allotment boundary or 900 mm from an obstruction to the breeze path such as a building, fence or other structure.

Explanatory information:

1. The opening height in (b)(iv) is to provide a breeze path and is likely to be the measurement from the floor to the underside of a perimeter beam. It is not a ceiling height measurement. It is also not a height for mounting a ceiling fan or the height of ceiling fan blades above the floor. These dimensions need to be determined considering the activities in the space, the safety of occupants of the space and any appropriate safety standards.
2. There is some survey evidence that suggests the majority of home owners turn off their air-conditioners when using an outdoor living area. Another cost effective option is to install a reed switch or other micro switch on the door leading to the outdoor living area in

ENERGY EFFICIENCY

order to automatically deactivate an air-conditioning unit when the door is left open for a period which allows occupants to enter and leave the air-conditioned space but does not affect the operation of the air-conditioner.

3. A side referred to in (b)(v) may contain some obstructions such as columns and barriers. Where an open side is *required* to have a 1 m barrier, consideration as to the type (wire, solid or other) should be made with regard to the overall opening area of the two sides.
- (d) Where a ceiling fan is *required* as part of compliance with (a)(ii) or (a)(iii), the fan must comply with 3.12.4.3.

PART 3.12.1 BUILDING FABRIC

3.12.1 Application

- (a) The provisions of 3.12.1.1 to 3.12.1.5 apply to—
 - (i) a Class 1 building; and
 - (ii) a Class 10a building with a *conditioned space*.
- (b) The provisions of 3.12.1.6 apply to a Class 1 building with an attached Class 10a building.

Acceptable construction practice

3.12.1.1 Building fabric thermal insulation

- (a) Where *required*, insulation must comply with AS/NZS 4859.1 and be installed so that it—
 - (i) abuts or overlaps adjoining insulation other than at supporting members such as columns, studs, noggings, joists, furring channels and the like where the insulation must butt against the member; and
 - (ii) forms a continuous barrier with ceilings, walls, bulkheads, floors or the like that inherently contribute to the thermal barrier; and

Explanatory information:

For example, in a two storey house with the second storey set back, the insulation in the first storey wall, the second storey wall and the roof over the set-back must be continuous. Therefore if the roof over the set-back has insulation on a horizontal ceiling, then insulation is also needed on the vertical in any ceiling space in order to connect the ceiling insulation to the second storey wall.

- (iii) does not affect the safe or effective operation of a *domestic service* or fitting.

Explanatory information:

Care should be taken when installing insulation to ensure that it does not interfere with the safety or performance of *domestic services* and fittings such as heating flues, recessed light fittings, light transformers, gas appliances and general plumbing and electrical components. This includes providing appropriate clearance as detailed in relevant legislation and referenced standards such as for electrical, gas and fuel oil installations.

- (b) Where *required*, *reflective insulation* must be installed with—
 - (i) the necessary airspace, to achieve the required *R-Value* between a reflective side of the *reflective insulation* and a building lining or cladding; and

ENERGY EFFICIENCY

Explanatory information: Airspace adjoining reflective insulation

For *reflective insulation* and the adjoining airspace to achieve its tested *R-Value*, the airspace needs to be a certain width. This width varies depending on the particular type of *reflective insulation* and the *R-Value* to be achieved.

- (ii) the *reflective insulation* closely fitted against any penetration, door or *window* opening; and
- (iii) the *reflective insulation* adequately supported by framing members; and
- (iv) each adjoining sheet of roll membrane being—
 - (A) overlapped not less than 150 mm; or
 - (B) taped together.

Explanatory information: Adjoining sheets of roll membrane

Where *reflective insulation* also acts as a vapour barrier or sarking, both the minimum overlap and taping may be necessary.

- (c) Where *required*, bulk insulation must be installed so that—
 - (i) it maintains its position and thickness, other than where it crosses roof battens, water pipes, electrical cabling or the like; and

Explanatory information: Compression of bulk insulation

The *R-Value* of bulk insulation is reduced if it is compressed. The allocated space for bulk insulation must therefore allow the insulation to be installed so that it maintains its correct thickness when using the product's stated *R-Value*, otherwise the *R-Value* needs to be reduced to account for any compression. This is particularly relevant to wall and cathedral ceiling framing whose members can only accommodate a limited thickness of insulation. In some instances, larger framing members or thinner insulation material, such as polystyrene boards, may be necessary to ensure that the insulation achieves its *required R-Value*.

- (ii) in a ceiling, where there is no bulk insulation or *reflective insulation* in the *external wall* beneath, it overlaps the *external wall* by not less than 50 mm.

Explanatory information:

1. The *R-Value* of *reflective insulation* and its adjoining airspace is affected by the width of the airspace between a reflective side of the *reflective insulation* and the building lining or cladding. For further information on *reflective insulation*, refer to the explanatory information accompanying **Figure 3.12.1.1**.
2. Artificial cooling of buildings in some climates can cause condensation to form inside the layers of the building *envelope*. Such condensation can cause significant structural or cosmetic damage to the *envelope* before it is detected. Associated mould growth may also create health risks to the occupants. Effective control of condensation is a complex issue. In some locations a fully sealed vapour barrier may need to be installed on the more humid, or generally warmer, side of the insulation.

ENERGY EFFICIENCY

3.12.1.2 Roofs

- (a) Subject to (b) and 3.12.1.2(e), a roof must—
- (i) achieve the *Total R-Value* specified in Table 3.12.1.1a for the direction of heat flow; and
 - (ii) where a pitched roof has a flat ceiling, have not less than 50% of the added insulation laid on the ceiling.
- (b) In *climate zones* 1, 2, 3, 4 and 5 the *Total R-Value* specified in Table 3.12.1.1a is reduced by 0.5 where the *required* insulation is laid on the ceiling and the roof space is ventilated by—
- (i) gable vents, ridge vents, eave vents, roof vents or the like that—
 - (A) are evenly distributed to allow an unobstructed flow of air; and
 - (B) are located to ensure, where practicable, there are no dead airspaces; and
 - (C) have an aggregate fixed open area of not less than 1.0% of the ceiling area; or
 - (ii) not less than 2 wind-driven roof ventilators having an aggregate opening area of not less than 0.14 m² in conjunction with gable vents, ridge vents, eave vents, roof vents or the like having an aggregate fixed open area of not less than 0.2% of the ceiling area.

Table 3.12.1.1a ROOF AND CEILING—MINIMUM TOTAL R-VALUE

<i>Climate zone</i>	1	2		3	4 and 5	6 and 7	8
		Altitude less than 300 m	Altitude 300 m or more				
Direction of heat flow	Downwards		Downwards and upwards		Upwards		
Minimum <i>Total R-Value</i> for a roof with an upper surface solar absorptance value of not more than 0.4	3.1	4.1	4.1		4.1	4.6	6.3
Minimum <i>Total R-Value</i> for a roof with an upper surface solar absorptance value of more than 0.4 but not more than 0.6	4.1	4.6	4.6		4.6	5.1	6.3

ENERGY EFFICIENCY

Table 3.12.1.1a ROOF AND CEILING—MINIMUM TOTAL R-VALUE — continued

Climate zone	1	2		3	4 and 5	6 and 7	8
		Altitude less than 300 m	Altitude 300 m or more				
Minimum <i>Total R-Value</i> for a roof or ceiling with a roof upper surface solar absorptance value of more than 0.6	5.1	5.1	5.1	5.1	5.1	5.1	6.3

Note: Altitude means the height above the Australian Height Datum at the location where the building is to be constructed.

Explanatory information:

- The roof space ventilation option, in *climate zones* 1, 2, 3, 4 and 5, applies to a pitched roof with a flat ceiling to ensure that efficient cross ventilation is achieved in the roof space to remove hot air. Roof space ventilation is generally not suitable for most flat, skillion, cathedral ceiling and similar roof types because of the lack of space between the ceiling and roof.
- Care should be taken to ensure that the roof *ventilation openings* do not allow rain penetration and that they comply with appropriate bushfire provisions.
- Gaps between roof tiles with sarking (or *reflective insulation* at rafter level) and metal sheet roofing are not acceptable methods of providing roof space ventilation.
- Compliance with the ventilation provisions in **3.12.1.2(b)(ii)** may result in the ingress of wind driven rain, fine dust, corrosive aerosols, or stimulate the growth of mould or fungus in the roof enclosure. Consideration should therefore be given to the surrounding environmental features, including exposure to marine or industrial environments, prior to adopting this as an alternative to the roof insulation provisions in **3.12.1.2(b)(i)**.
- A low solar absorptance roof reduces the flow of heat from solar radiation better than a high solar absorptance roof. A roof with a solar absorptance value of less than 0.4 typically corresponds to a roof of light colour such as white, off-white or cream. Typical absorptance values based on ASTM E903 are as follows.

Typical Absorptance Values

Colour	Value
Slate (dark grey)	0.90
Red, green	0.75
Yellow, buff	0.60
Zinc aluminium — dull	0.55
Galvanised steel — dull	0.55
Light grey	0.45

ENERGY EFFICIENCY

Typical Absorptance Values — continued

Colour	Value
Off white	0.35
Light cream	0.30

6. The direction of heat flow in [Table 3.12.1.1a](#) is considered to be the predominant direction of heat flow for the hours of occupation of the building. It takes into account the higher rate of occupancy of houses at night time rather than day time.
7. The weight of roof or ceiling insulation, particularly if additional ceiling insulation is used for compliance with the energy efficiency provisions, needs to be considered in the selection of plasterboard, plasterboard fixings and building framing.

(c) A roof that—

- (i) is *required* to achieve a minimum *Total R-Value*; and
- (ii) has metal sheet roofing directly fixed to metal purlins, metal rafters or metal battens; and
- (iii) does not have a ceiling lining or has a ceiling lining fixed directly to those metal purlins, metal rafters or metal battens (see [Figure 3.12.1.1\(b\)](#)),

must have a thermal break, consisting of a material with an *R-Value* of not less than 0.2, installed between the metal sheet roofing and its supporting metal purlins, metal rafters, or metal battens.

(d) A roof, or roof and associated ceiling, is deemed to have the *Total R-Value* in [Figure 3.12.1.1](#).

Figure 3.12.1.1 TOTAL R-VALUE FOR TYPICAL ROOF AND CEILING CONSTRUCTION

Roof construction description		<i>Total R-Value</i>		
(a)	Flat roof, skillion roof and cathedral ceiling — Ceiling lining under rafter		Down	0.48
			Up	0.36

ENERGY EFFICIENCY

Figure 3.12.1.1 TOTAL R-VALUE FOR TYPICAL ROOF AND CEILING CONSTRUCTION — continued

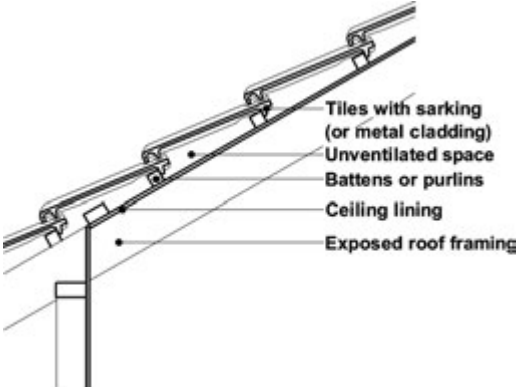
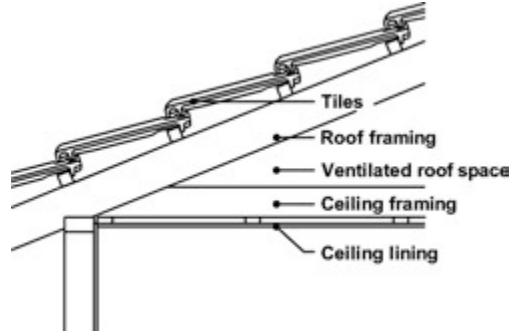
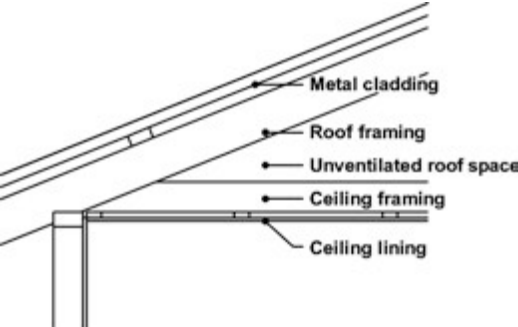
Roof construction description		Total R-Value		
		Down	Up	
(b) Flat roof, skillion roof and cathedral ceiling — Exposed rafters		Unventilated	Down	0.44
			Up	0.38
(c) Pitched roof with flat ceiling — Tiled roof		Ventilated	Down	0.74
			Up	0.23
		Unventilated	Down	0.56
			Up	0.41
(d) Pitched roof with flat ceiling — Metal roof		Ventilated	Down	0.72
			Up	0.21
		Unventilated	Down	0.54
			Up	0.39

Notes:

- The *Total R-Value* of the roof and ceiling construction in [Figure 3.12.1.1](#) is based on there being a roof space. If the roof space is filled, the roof space *R-Value* needs to be subtracted from the *Total R-Value* of the roof and ceiling materials.

ENERGY EFFICIENCY

Figure 3.12.1.1 TOTAL R-VALUE FOR TYPICAL ROOF AND CEILING CONSTRUCTION — continued

Roof construction description	Total R-Value
2. The <i>Total R-Value</i> of the unventilated roof and ceiling construction in Figure 3.12.1.1(c) for tiled roofs are based on there being <i>sarking-type material</i> which would prevent ventilation of the roof space through the gaps in the roof tiles.	

Explanatory information:

1. Typical construction:

Figure 3.12.1.1 provides examples of various roof and ceiling construction. The *R-Value* of the *required* insulation is calculated by subtracting the inherent *Total R-Value* of the roof and ceiling construction from the *Total R-Value* in **Table 3.12.1.1**. The inherent *Total R-Value* of the typical roof and ceiling has been determined by adding together the *R-Values* of the outdoor air film, roof cladding, roof airspace, ceiling sheet lining and internal film.

2. The *Total R-Value* of the roof and ceiling materials may need to be adjusted if other building elements such as sarking are also installed. For example, sarking or sheet insulation under tiles may change a roof space from “ventilated” to “unventilated”.

3. Thermal bridging:

Irrespective of the framing material used, the minimum added *R-Value* specified in **Figures 3.12.1.1** and **3.12.1.3** and **Table 3.12.1.4** is deemed to include the effect of thermal bridging created by framing members in situations other than described in explanatory note 4.

4. Thermal break:

Because of the high thermal conductance of metal, a thermal break is to be provided where the ceiling lining of a house is fixed directly to the underside of the metal purlins or metal battens of a metal deck roof or where there is no ceiling lining. The purpose of the thermal break is to ensure that the thermal performance of this form of roof construction is comparable to that of a similar roof with timber purlins or timber battens.

A thermal break may be provided by materials such as timber, expanded polystyrene strips, plywood or compressed bulk insulation. The material used as a thermal break must separate the metal purlins or metal battens from the metal deck roofing and achieve the specified *R-Value*. *Reflective insulation* alone is not suitable for use as a thermal break because it requires an adjoining airspace to achieve the specified *R-Value* (see explanatory note 6).

For the purposes of **3.12.1.2(c)**, expanded polystyrene strips of not less than 12 mm thickness, compressed bulk insulation, and timber of not less than 20 mm thickness are considered to achieve a *R-Value* of not less than 0.2.

5. Location of insulation:

The thermal performance of the roof may vary depending on the position of the insulation, the climatic conditions, the design of the house and the way in which it is operated. For example, insulation installed under the roof, rather than on the ceiling, of a conditioned house with a large roof space is less effective because of the additional volume of roof airspace that would need to be heated or cooled. Conversely, for an unconditioned house, the use of *reflective insulation* is more effective when placed directly under the roof.

6. Choice of insulation:

There are a number of different insulation products that may be used to achieve the minimum added *R-Value*. However, care should be taken to ensure that the choice

ENERGY EFFICIENCY

made is appropriate for the construction and climatic conditions as the location and relationship between options in [Figures 3.12.1.1](#) and [3.12.1.3](#) and [Table 3.12.1.4](#) may not be suitable in all circumstances for both practical and technical reasons. For instance, in some *climate zones*, insulation should be installed with due consideration of condensation and associated interaction with adjoining building materials. As an example, *reflective insulation* or sarking installed on the cold side of the building *envelope* should be vapour permeable.

Reflective insulation is considered to provide the following additional *R-Values* when used in conjunction with the *Total R-Value* of a pitched roof and flat ceiling construction described in [Figure 3.12.1.1](#). To achieve these values, the *reflective insulation* must be laid directly under the roof cladding and have a minimum airspace of 15 mm between a reflective side of the *reflective insulation* and the adjoining lining or roof cladding (see [3.12.1.1\(b\)](#)).

The actual *R-Value* added by *reflective insulation* and its adjoining airspace should be determined for each product in accordance with the standard prescribed in [3.12.1.1\(a\)](#), which takes into consideration factors such as the number of adjacent airspaces, dimensions of the adjacent airspace, whether the space is ventilated and the presence of an anti-glare coating. When *reflective insulation* has an anti-glare coating on one side, the emittance value of that side will be greater than the value of the uncoated side.

Also, where another emittance value for *reflective insulation* is used (other than the value used in the table below), care should be taken to ensure that the number of airspaces allowed for is consistent with the form of construction and whether the airspace is reflective, partially reflective or non-reflective. Where bulk insulation fills the airspace, the *Total R-Value* should be reduced to take account of the loss of airspace.

Emittance of added <i>reflective insulation</i>	Direction of heat flow	<i>R-Value added by reflective insulation</i>					
		Pitched roof (>10°) with horizontal ceiling		Flat skillion or pitched roof (≤10°) with horizontal ceiling	Pitched roof with cathedral ceilings		
		Unventilated roof space	Ventilated roof space		15° to not more than 25° pitch	more than 25° to not more than 35° pitch	more than 35° to 45° pitch
0.2 outer 0.05 inner	Downwards	1.12	1.21	1.28	0.96	0.86	0.66
0.2 outer 0.05 inner	Upwards	0.75	0.59	0.68	0.72	0.74	0.77
0.9 outer 0.05 inner	Downwards	0.92	1.01	1.06	0.74	0.64	0.44
0.9 outer 0.05 inner	Upwards	0.55	0.40	0.49	0.51	0.52	0.53

Notes:

1. The direction of heat flow applicable in each *climate zones* specified in [Table 3.12.1.1a](#).
2. Ventilated roof space means ventilated in accordance with [3.12.1.2\(b\)](#).

ENERGY EFFICIENCY

- (e) Where, for operational or safety reasons associated with exhaust fans, flues or recessed downlights, the area of *required* ceiling insulation is reduced, the loss of insulation must be compensated for by increasing the *R-Value* of insulation in the remainder of the ceiling in accordance with [Table 3.12.1.1b](#).

Table 3.12.1.1b ADJUSTMENT OF MINIMUM R-VALUE FOR LOSS OF CEILING INSULATION

Percentage of ceiling area uninsulated	Minimum <i>R-Value</i> of ceiling insulation <i>required</i> to satisfy 3.12.1.2(a)										
	1.0	1.5	2.0	2.5	3.0	3.5	4.0	4.5	5.0	5.5	6.0
	Adjusted minimum <i>R-Value</i> of ceiling insulation <i>required</i> to compensate for loss of ceiling insulation area										
0.5% to less than 1.0%	1.0	1.6	2.2	2.8	3.4	4.0	4.7	5.4	6.2	6.9	
1.0% to less than 1.5%	1.1	1.7	2.3	2.9	3.6	4.4	5.2	6.1	7.0		
1.5% to less than 2.0%	1.1	1.7	2.4	3.1	3.9	4.8	5.8	6.8			
2.0% to less than 2.5%	1.1	1.8	2.5	3.3	4.2	5.3	6.5				
2.5% to less than 3.0%	1.2	1.9	2.6	3.6	4.6	5.9					
3.0% to less than 4.0%	1.2	2.0	3.0	4.2	5.7						
4.0% to less than 5.0%	1.3	2.2	3.4	5.0							
5.0% or more											
Not permitted											

Note: Where the minimum *R-Value* of ceiling insulation *required* to satisfy [3.12.1.2\(a\)](#) is between the values stated, interpolation may be used to determine the adjusted minimum *R-Value*.

Explanatory information:

- When considering the reduction of insulation because of exhaust fans, flues or recessed downlights, 0.5% of the ceiling area for a 200 m² house would permit 2 bathroom heater-light assemblies, a laundry exhaust fan, a kitchen exhaust fan and either approximately 20 recessed downlights with 50 mm clearance to insulation, 10 recessed downlights with 100 mm clearance to insulation or only 3 recessed downlights with 200 mm clearance to insulation.
- Note that [Table 3.12.1.1b](#) refers to the *R-Value* of the insulation located on the ceiling and is not the *Total R-Value required* of the roof. The roof has an inherent *R-Value* and there may also be insulation at the roof line.
- Note that [3.12.1.2\(e\)](#) does not require an increase in ceiling insulation for *roof lights*.
- Placing some of the *required* insulation at the roof level may result in a more practical outcome. Insulation at the roof level is effective in warm climates and significantly moderates the roof space extremes and condensation risk in cold climates.

ENERGY EFFICIENCY

3.12.1.3 Roof lights

Roof lights (including any associated shaft and diffuser) serving a *habitable room* or an interconnecting space such as a corridor, hallway, stairway or the like must—

- (a) if the *roof lights* are not *required* for compliance with **Part 3.8**—
- (i) comply with **Table 3.12.1.2**; and
 - (ii) have an aggregate area of not more than 3% of the total *floor area* of the storey served; or
- (b) if the *roof lights* are *required* for compliance with **Part 3.8**—
- (i) have an area not more than 150% of the minimum area required by **Part 3.8.5**; and
 - (ii) have transparent and translucent elements, including any imperforate ceiling diffuser with—
 - (A) an *Total System SHGC* of not more than 0.29; and
 - (B) a *Total System U-Value* of not more than 2.9.

Table 3.12.1.2 ROOF LIGHTS — THERMAL PERFORMANCE OF TRANSPARENT AND TRANSLUCENT ELEMENTS

<i>Roof lights</i> shaft index (see Note 1)	Constant	Total area of <i>roof lights</i> serving the room or space as a percentage of the <i>floor area</i> of the room or space			
		Not more than 2%	More than 2% to not more than 3%	More than 3% to not more than 4%	More than 4% to not more than 5%
Less than 0.5	<i>Total System SHGC</i>	Not more than 0.83	Not more than 0.57	Not more than 0.43	Not more than 0.34
	<i>Total System U-Value</i>	Not more than 8.5	Not more than 5.7	Not more than 4.3	Not more than 3.4
0.5 to less than 1.0	<i>Total System SHGC</i>	Not more than 0.83	Not more than 0.72	Not more than 0.54	Not more than 0.43
	<i>Total System U-Value</i>	Not more than 8.5	Not more than 5.7	Not more than 4.3	Not more than 3.4
1.0 to less than 2.5	<i>Total System SHGC</i>	Not more than 0.83	Not more than 0.83	Not more than 0.69	Not more than 0.55
	<i>Total System U-Value</i>	Not more than 8.5	Not more than 5.7	Not more than 4.3	Not more than 3.4

ENERGY EFFICIENCY

Table 3.12.1.2 ROOF LIGHTS — THERMAL PERFORMANCE OF TRANSPARENT AND TRANSLUCENT ELEMENTS — continued

Roof lights shaft index (see Note 1)	Constant	Total area of <i>roof lights</i> serving the room or space as a percentage of the <i>floor area</i> of the room or space			
		Not more than 2%	More than 2% to not more than 3%	More than 3% to not more than 4%	More than 4% to not more than 5%
2.5 and above	<i>Total System SHGC</i>	Not more than 0.83	Not more than 0.83	Not more than 0.83	Not more than 0.83
	<i>Total System U-Value</i>	Not more than 8.5	Not more than 5.7	Not more than 4.3	Not more than 3.4

Notes:

- The *roof light* shaft index is determined by measuring the distance from the centre of the shaft at the roof to the centre of the shaft at the ceiling level and dividing it by the average internal dimension of the shaft opening at the ceiling level (or the diameter for a circular shaft) in the same units of measurement.
- The total area of *roof lights* is the combined area for all *roof lights* serving the room or space.
- The area of a *roof light* is the area of the roof opening that allows light to enter the building.
- The thermal performance of an imperforate ceiling diffuser may be included in the *Total System U-Value* of the *roof light*.
- The total area of *roof lights* serving the room or space as a percentage of the *floor area* of the room or space must not exceed 5% unless allowed by 3.12.1.3(b).

Explanatory information:

- The *Total System SHGC* and *Total System U-Values* are expressed as Australian Fenestration Rating Council (AFRC) values.
- The *Total System SHGC* and *Total System U-Values* are for a *roof light* with or without a ceiling diffuser. A *roof light* may achieve the *required* performance on its own or in conjunction with a ceiling diffuser.
- The *Total System SHGC* and *Total System U-Values* for some simple types of *roof lights* are shown in the table below. Smaller numbers indicate better *glazing* element performance. The table gives worst case assessments, which can be improved by obtaining generic or custom product assessments from suppliers, manufacturers, industry associations (including their online resources) and from competent assessors.

WORST CASE WHOLE ROOF LIGHT ELEMENT PERFORMANCE VALUES WITHOUT A CEILING DIFFUSER OR WITH A PERFORATED CEILING DIFFUSER				
Translucent or transparent element description	Domed panel		Flat, framed panel	
	<i>Total System SHGC</i>	<i>Total System U-Values</i>	<i>Total System SHGC</i>	<i>Total System U-Values</i>
Single layer clear	0.80	8.4	0.79	8.0

ENERGY EFFICIENCY

Single tinted	0.66	8.4	0.63	7.9
Single layer translucent ("opal")	0.57	8.4	0.56	7.9
Double layer clear	0.71	5.4	0.70	4.9
WORST CASE WHOLE ROOF LIGHT ELEMENT PERFORMANCE VALUES WITH AN IMPERFORATE CEILING DIFFUSER				
Translucent or transparent element description	Domed panel		Flat, framed panel	
	<i>Total System SHGC</i>	<i>Total System U-Values</i>	<i>Total System SHGC</i>	<i>Total System U-Values</i>
Single layer clear	0.72	4.3	0.71	4.2
Single tinted	0.59	4.3	0.57	4.2
Single layer translucent ("opal")	0.51	4.3	0.50	4.2
Double layer clear	0.64	3.4	0.63	3.2

3.12.1.4 External walls

- (a) Each part of an *external wall* must satisfy the requirements of [Table 3.12.1.3a](#) for all walls, or [Table 3.12.1.3b](#) for walls with a surface density of not less than 220 kg/m², except for—
- (i) opaque non-glazed openings such as doors (including garage doors), vents, penetrations, shutters and the like; and
 - (ii) *glazing* unless covered by [Table 3.12.1.3b](#).

Explanatory information:

Surface density is the mass of one vertical square metre of wall.

Table 3.12.1.3a — OPTIONS FOR EACH PART OF AN EXTERNAL WALL

<i>Climate Zone</i>	Options
1, 2, 3, 4 and 5	(a) Achieve a minimum <i>Total R-Value</i> of 2.8.
	(b) (i) Achieve a minimum <i>Total R-Value</i> of 2.4; and (ii) shade the <i>external wall</i> of the storey with a verandah, balcony, eaves, carport or the like, which projects at a minimum angle of 15 degrees in accordance with Figure 3.12.1.2 .
6 and 7	Achieve a minimum <i>Total R-Value</i> of 2.8.
8	Achieve a minimum <i>Total R-Value</i> of 3.8.

ENERGY EFFICIENCY

Table 3.12.1.3b — OPTIONS FOR EACH PART OF AN EXTERNAL WALL WITH A SURFACE DENSITY OF NOT LESS THAN 220 kg/m²

Climate Zone	Options
1, 2 and 3	<p>(a) (i) For a storey, other than one with another storey above, shade the wall with a verandah, balcony, eaves, carport or the like which projects at a minimum angle of 15 degrees in accordance with Figure 3.12.1.2; and</p> <p>(ii) when the <i>external walls</i> are not shaded in accordance with (i) and there is another storey above, external <i>glazing</i> complies with 3.12.2.1 with the applicable value for C_{SHGC} in Table 3.12.2.1 reduced by 20%; and</p> <p>(iii) the <i>external wall</i> incorporates insulation with an <i>R-Value</i> of not less than 0.5; and</p> <p>(iv) the lowest storey containing <i>habitable rooms</i> has—</p> <p>(A) a concrete slab-on-ground floor; or</p> <p>(B) masonry <i>internal walls</i>.</p>
5	<p>(a) (i) For a storey, other than one with another storey above, shade the wall with a verandah, balcony, eaves, carport or the like which projects at a minimum angle of 15 degrees in accordance with Figure 3.12.1.2; and</p> <p>(ii) when the <i>external walls</i> are not shaded in accordance with (i) and there is another storey above, external <i>glazing</i> complies with 3.12.2.1 with the applicable value for C_{SHGC} in Table 3.12.2.1 reduced by 15%; and</p> <p>(iii) the <i>external wall</i> incorporates insulation with an <i>R-Value</i> of not less than 0.5; and</p> <p>(iv) the lowest storey containing <i>habitable rooms</i> has—</p> <p>(A) a concrete slab-on-ground floor; or</p> <p>(B) masonry <i>internal walls</i>.</p>
	<p>(b) (i) Shade the wall with a verandah, balcony, eaves, carport or the like which projects at a minimum angle of 15 degrees in accordance with Figure 3.12.1.2; and</p> <p>(ii) external <i>glazing</i> complies with 3.12.2.1 with the applicable value for C_{SHGC} in Table 3.12.2.1 reduced by 15%; and</p> <p>(iii) the lowest storey containing <i>habitable rooms</i> has—</p> <p>(A) a concrete slab-on-ground floor; and</p> <p>(B) masonry <i>internal walls</i>.</p>

ENERGY EFFICIENCY

Table 3.12.1.3b — OPTIONS FOR EACH PART OF AN EXTERNAL WALL WITH A SURFACE DENSITY OF NOT LESS THAN 220 kg/m² — continued

Climate Zone	Options
4 and 6	(a) (i) The external <i>glazing</i> complies with 3.12.2.1 with the applicable value for C _u in Table 3.12.2.1 reduced by 15%; and (ii) the <i>external wall</i> incorporates insulation with an <i>R-Value</i> of not less than 0.5; and (iii) the lowest storey containing <i>habitable rooms</i> has— (A) a concrete slab-on-ground floor; or (B) masonry <i>internal walls</i> .
	(b) The external <i>glazing</i> complies with 3.12.2.1 with the applicable value for C _u in Table 3.12.2.1 reduced by 20%.
	(c) (i) The <i>external wall</i> incorporates insulation with an <i>R-Value</i> of not less than 1.0; and (ii) the lowest storey containing <i>habitable rooms</i> has— (A) a concrete slab-on-ground floor; or (B) masonry <i>internal walls</i> .
7	(a) (i) The external <i>glazing</i> complies with 3.12.2.1 with the applicable value for C _u in Table 3.12.2.1 reduced by 15%; and (ii) the <i>external wall</i> incorporates insulation with an <i>R-Value</i> of not less than 1.0.
	(b) (i) The external <i>glazing</i> complies with 3.12.2.1 with the applicable value for C _u in Table 3.12.2.1 reduced by 20%; and (ii) the <i>external wall</i> incorporates insulation with an <i>R-Value</i> of not less than 0.5.
	(c) The <i>external wall</i> incorporates insulation with an <i>R-Value</i> of not less than 1.5.
8	Achieve a minimum <i>Total R-Value</i> of 3.8.

ENERGY EFFICIENCY

Figure 3.12.1.2

MEASUREMENT OF A PROJECTION FOR WALL SHADING

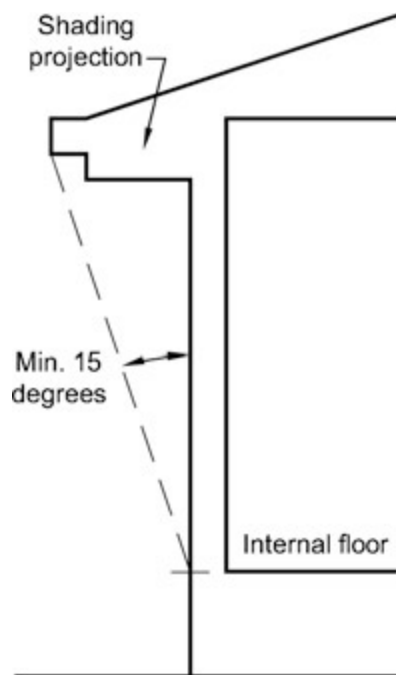
**Explanatory information:**

Guttering can be considered as providing shading if attached to a shading projection.

- (b) A wall in [Table 3.12.1.3a](#) that—
- (i) has lightweight external cladding such as weatherboards, fibre-cement or metal sheeting fixed to the metal frame; and
 - (ii) does not have a wall lining or has a wall lining that is fixed directly to the metal frame (see [Figure 3.12.1.3\(a\)](#) and [\(b\)](#)),

must have a thermal break, consisting of a material with an *R-Value* of not less than 0.2, installed between the external cladding and the metal frame.

Explanatory information:

1. The thermal performance of metal and timber framed walls is affected by conductive thermal bridging by the framing members and convective thermal bridging at gaps between the framing and any added bulk insulation. Metal framed walls are more prone to conductive thermal bridging than timber framed walls.
2. Because of the high thermal conductance of metal, a thermal break is needed when a metal framing member directly connects the external cladding to the internal lining or the internal environment. The purpose of the thermal break is to ensure that the thermal performance of the metal framed wall is comparable to that of a similarly clad timber framed wall.

ENERGY EFFICIENCY

A thermal break may be provided by materials such as timber battens, plastic strips or polystyrene insulation sheeting. The material used as a thermal break must separate the metal frame from the cladding and achieve the specified *R-Value*.

For the purposes of 3.12.1.4(b)(ii), expanded polystyrene strips of not less than 12 mm thickness and timber of not less than 20 mm thickness are deemed to achieve an *R-Value* of not less than 0.2.

The *R-Value* of the thermal break is not included when calculating the *Total R-Value* of the wall, if the thermal break is only applied to the metal frame, because this calculation is done for locations free of framing members.

- (c) A wall constructed in accordance with **Figure 3.12.1.3** is deemed to have the *Total R-Value* specified in that Figure if it has an airspace.

Figure 3.12.1.3 TOTAL R-VALUE FOR TYPICAL WALL CONSTRUCTION

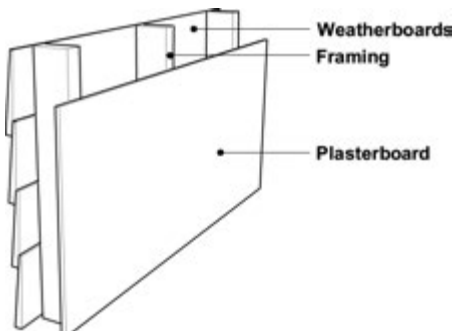
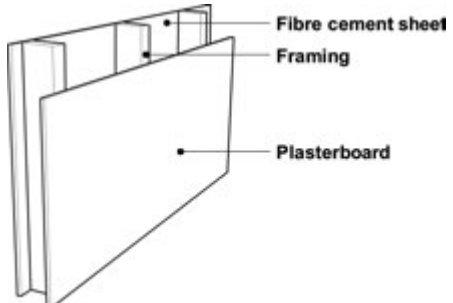
<i>External wall</i> construction description		<i>Total R-Value</i>
(a)	Weatherboard  <p>Labels: Weatherboards, Framing, Plasterboard</p>	0.48
(b)	Fibre-cement sheet  <p>Labels: Fibre cement sheet, Framing, Plasterboard</p>	0.42

ENERGY EFFICIENCY

Figure 3.12.1.3 TOTAL R-VALUE FOR TYPICAL WALL CONSTRUCTION — continued

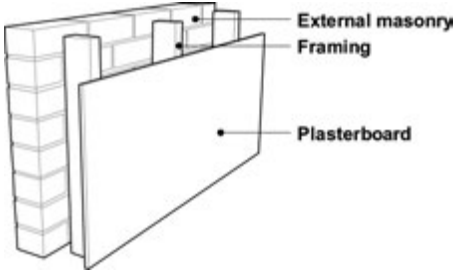
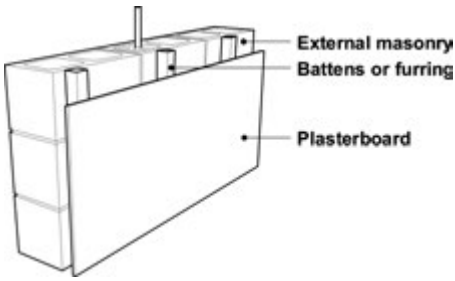
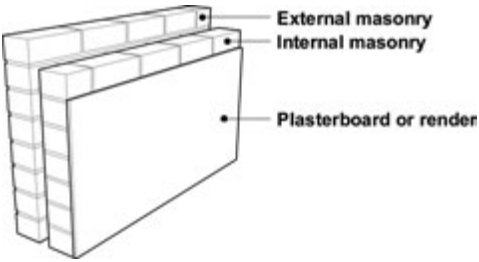
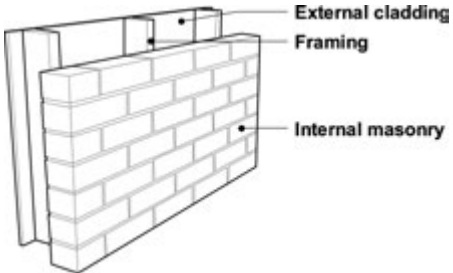
<i>External wall</i> construction description	<i>Total R-Value</i>
<p>(c) Clay masonry veneer</p>  <p>External masonry Framing Plasterboard</p>	0.56
<p>(d) Concrete blockwork masonry</p>  <p>External masonry Battens or furring Plasterboard</p>	0.54
<p>(e) Cavity clay masonry</p>  <p>External masonry Internal masonry Plasterboard or render</p>	0.69
<p>(f) Externally insulated clay masonry</p>  <p>External cladding Framing Internal masonry</p>	0.53

ENERGY EFFICIENCY

Figure 3.12.1.3 TOTAL R-VALUE FOR TYPICAL WALL CONSTRUCTION — continued

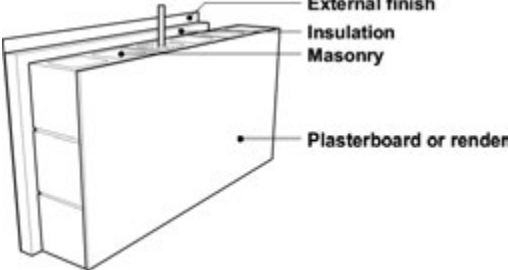
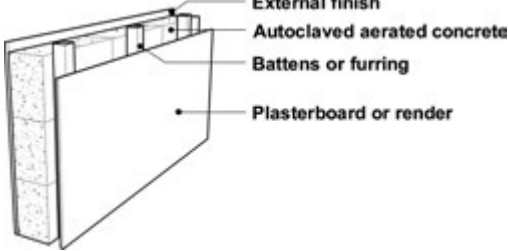
<i>External wall</i> construction description	<i>Total R-Value</i>
<p>(g) Externally insulated concrete masonry</p> 	0.46
<p>(h) Autoclaved aerated concrete masonry</p> 	2.42

Explanatory information:

1. **Figure 3.12.1.3** provides examples of typical types of wall construction. The additional *R-Value required* can be calculated by subtracting the inherent *Total R-Value* of the typical wall construction in **Figure 3.12.1.3** from the *required Total R-Value*. The inherent *Total R-Value* of the typical wall construction has been arrived at by adding together the *R-Values* for outdoor air film, wall cladding or veneer, wall *cavity* or airspace, internal lining and internal air film. Where a *cavity* or airspace is filled the *Total R-Value* should be reduced by 0.17 to take account of the loss of the *cavity* or airspace.
2. *Reflective insulation* with one reflective surface having an emittance and direction as indicated, is considered to achieve the following *R-Values* when used in conjunction with the *Total R-Value* of a wall construction, as described in **Figure 3.12.1.3**. The actual *R-Value* added by *reflective insulation* should be determined for each product in accordance with the standard prescribed in **3.12.1.1(a)**, which takes into consideration factors such as the number of adjacent airspaces, dimensions of the adjacent airspace, whether the airspace is ventilated and the presence of an anti-glare coating.

Wall construction	Reflective airspace details	<i>R-Value</i> added by <i>reflective insulation</i>
Concrete or masonry with internal plasterboard on battens	One 20 mm reflective airspace located between <i>reflective insulation</i> (of not more than 0.05 emittance inwards) and plasterboard	0.48

ENERGY EFFICIENCY

Wall construction	Reflective airspace details	R-Value added by reflective insulation
<i>External wall</i> cladding (70 mm timber frame with internal lining)	One 70 mm reflective airspace located between <i>reflective insulation</i> (of not more than 0.05 emittance inwards) and plasterboard	0.43
Masonry veneer (70 mm timber frame with internal lining)	a. One 70 mm reflective airspace located between <i>reflective insulation</i> and plasterboard; and b. One 25 mm anti-glare airspace located between <i>reflective insulation</i> (of not more than 0.2 emittance outwards) and masonry	0.95
<i>Cavity</i> masonry	a. No airspace between the <i>reflective insulation</i> and the inner leaf of masonry; and b. One 35 mm anti-glare airspace located between <i>reflective insulation</i> (of not more than 0.2 emittance outwards) and the outer leaf of masonry	0.50

3. For further information on *reflective insulation*, refer to the explanatory information following **Figure 3.12.1.1**.
4. Walls with a surface density of 220 kg/m² or more are deemed to achieve acceptable levels of thermal performance in certain *climate zones* due to their ability to store heat and therefore slow the heat transfer through the building *fabric*. These walls are defined by surface density (kg/m²), which is the mass of one vertical square metre of wall, in order to reduce the complexity when measuring the mass of walls with voids.
The following are examples of some typical wall constructions that achieve a surface density of 220 kg/m²:
 - (a) Two leaves each of 90 mm thick or greater clay or concrete masonry.
 - (b) 140 mm thick or greater dense-weight hollow concrete or clay blocks with—
 - (i) 10 mm plasterboard or render; and
 - (ii) at least one concrete grouted horizontal bond beam; and
 - (iii) vertical cores filled with concrete grout at centres not exceeding 1000 mm.
 - (c) 140 mm thick or greater concrete wall panels and dense-weight hollow concrete or clay blocks with all vertical cores filled with concrete grout.
 - (d) 190 mm thick or greater dense-weight hollow concrete or clay blocks with—
 - (i) at least one concrete grouted horizontal bond beam; and
 - (ii) vertical cores filled with concrete grout at centres not exceeding 1800 mm.
 - (e) Earth-wall construction with a minimum wall thickness of 200 mm.

3.12.1.5 Floors

- (a) A suspended floor, other than an intermediate floor in a building with more than one storey—

ENERGY EFFICIENCY

- (i) must achieve the *Total R-Value* specified in **Table 3.12.1.4**; and

Table 3.12.1.4 SUSPENDED FLOOR – MINIMUM TOTAL R-VALUE

Climate Zone	1	2	3	4	5	6	7	8
	Direction of heat flow							
	Upwards				Downwards			
Minimum Total R-Value	1.5	1.0	1.5	2.25	1.0	2.25	2.75	3.25

Note: For an enclosed perimeter treatment, the underfloor airspace and its enclosure may be included in the *Total R-Value* calculation.

- (ii) with an in-slab or in-screed heating or cooling system, must be insulated—
- (A) around the vertical edge of its perimeter with insulation having an *R-Value* of not less than 1.0; and
- (B) underneath the slab with insulation having an *R-Value* of not less than 2.0 which may include insulation installed to meet the requirements of (i); and
- (iii) that is enclosed beneath, must have a barrier to prevent convection installed below floor level between the airspace under the floor and any wall *cavities*.

Explanatory information:

1. An enclosed perimeter treatment means that the airspace under the floor is enclosed between ground and floor level by walls which have only the *required* sub-floor vents.
2. The barrier *required* by **3.12.1.5(a)(iii)** could be an impermeate flashing.
3. Specific solutions for concrete slab and timber floors can be found in documents and online resources prepared by industry associations and product suppliers.

- (b) A floor is deemed to have the *Total R-Value* specified in **Table 3.12.1.5**.

Table 3.12.1.5 TOTAL R-VALUE FOR TYPICAL SUSPENDED FLOOR CONSTRUCTION

Enclosure and height of floor	Direction of heat flow	<i>Total R-Value</i>			
		Cavity masonry	190 mm concrete masonry	Single skin masonry	9 mm fibre-cement sheet
(a) Suspended timber floor					
Enclosed - not more than 0.6 m high	Upwards	1.00	0.93	0.88	0.77
	Downwards	1.11	1.06	1.01	0.90
Enclosed - more than 0.6 m but to not more than 1.2 m high	Upwards	0.86	0.81	0.76	0.65
	Downwards	1.00	0.94	0.89	0.77
Enclosed - more than 1.2 m to not more than 2.4 m high	Upwards	0.76	0.72	0.67	0.57
	Downwards	0.89	0.84	0.79	0.69

ENERGY EFFICIENCY

Table 3.12.1.5 TOTAL R-VALUE FOR TYPICAL SUSPENDED FLOOR CONSTRUCTION — continued

Enclosure and height of floor	Direction of heat flow	Total R-Value			
		Cavity masonry	190 mm concrete masonry	Single skin masonry	9 mm fibre-cement sheet
Unenclosed	Upwards	0.39			
	Downwards	0.51			
(b) Suspended concrete floor					
Enclosed - not more than 0.6 m high	Upwards	0.93	0.88	0.83	0.72
	Downwards	1.06	1.01	0.96	0.85
Enclosed - more than 0.6 m but to not more than 1.2 m high	Upwards	0.81	0.76	0.71	0.60
	Downwards	0.94	0.89	0.84	0.72
Enclosed - more than 1.2 m to not more than 2.4 m high	Upwards	0.71	0.67	0.62	0.52
	Downwards	0.84	0.79	0.74	0.64
Unenclosed	Upwards	0.34			
	Downwards	0.46			
Notes:					
1. The height of the floor is measured from ground surface to the underside of the floor or the insulation.					
2. For the purposes of calculating the <i>Total R-Value</i> of a floor, the <i>R-Value</i> attributable to an in-slab or in-screed heating or cooling system is ignored.					

Explanatory information:

- Table 3.12.1.5 provides examples of the inherent *Total R-Values* of enclosed and unenclosed suspended floors of two typical types of construction. Any added *R-Value* can be calculated by subtracting the inherent *R-Value* of the typical construction in Table 3.12.1.5 from the *required Total R-Value* in Table 3.12.1.4.
- Any non-reflective building membrane fixed between or under floor joists is considered to add an *R-Value* of 0.2 to the *Total R-Value* of the base construction described in Table 3.12.1.5. *Reflective insulation* will achieve a higher value which will need to be determined for each product in accordance with AS/NZS 4859.1. Typically, a reflective building membrane attached beneath the floor joists of an unenclosed floor, with a single bright side facing upwards to a 90 mm airspace, can add an *R-Value* of 0.43 for heat flow upwards and 1.32 for heat flow downwards. Double sided *reflective insulation* with a 90 mm airspace installed under an enclosed floor can add an *R-Value* of 0.55 for heat flow upwards and 1.97 for heat flow downwards. Both examples allow for dust on the upper surface in accordance with AS/NZS 4859.1.
- A reflective or non-reflective building membrane should be installed with due consideration of potentially damaging condensation in some *climate zones* and associated interaction with adjoining building materials.
- For further information on *reflective insulation*, refer to the explanatory information accompanying Figure 3.12.1.1.

ENERGY EFFICIENCY

- (c) A concrete slab-on-ground—
- (i) with an in-slab or in-screed heating or cooling system, must have insulation with an *R-Value* of not less than 1.0, installed around the vertical edge of its perimeter; and
 - (ii) when in *climate zone* 8, must be insulated—
 - (A) around the vertical edge of its perimeter with insulation having an *R-Value* of not less than 1.0; and
 - (B) underneath the slab with insulation having an *R-Value* of not less than 2.0.
- (d) Insulation *required* by (c)(i) and (c)(ii)(A) must—
- (i) be water resistant; and
 - (ii) be continuous from the adjacent finished ground level—
 - (A) to a depth of not less than 300 mm; or
 - (B) for at least the full depth of the vertical edge of the concrete slab-on-ground (see [Figure 3.12.1.4](#)).
- (e) The requirements of (a)(ii), and (c)(i) do not apply to an in-screed heating or cooling system used solely in a bathroom, amenity area or the like.

Explanatory information:

[3.12.1.5\(e\)](#) provides an exemption for an in-screed heating or cooling system used solely in bathrooms, amenity areas and the like, as these are typically small areas.

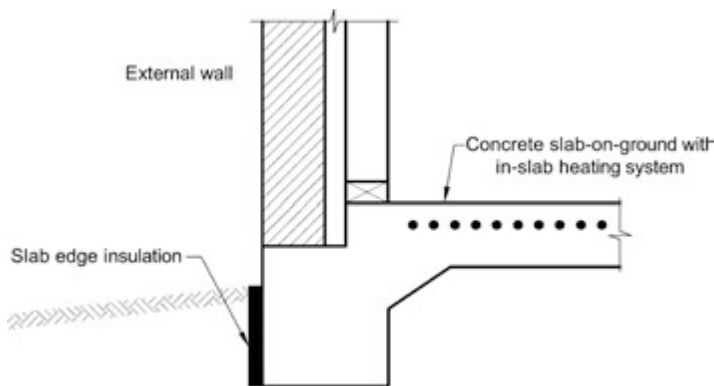
Figure 3.12.1.4**INSULATION OF SLAB EDGE****Explanatory information:**

Care should be taken to ensure that the type of termite management system selected is compatible with the slab edge insulation.

3.12.1.6 Attached Class 10a buildings

A Class 10a building attached to a Class 1 building must—

- (a) have an external *fabric* that achieves the *required* level of thermal performance for a Class 1 building; or

ENERGY EFFICIENCY

- (b) be separated from the Class 1 building with construction having the *required* level of thermal performance for the Class 1 building; or
- (c) in *climate zone* 5—
 - (i) be enclosed with masonry walls other than where there are doors and *glazing*; and
 - (ii) be separated from the Class 1 building with a masonry wall that extends to the ceiling or roof; and
 - (iii) achieve a *Total R-Value* in the roof equivalent to that *required* by **Table 3.12.1.1** for the Class 1 building; and
 - (iv) not have a garage door facing the east or west orientation other than if the Class 1 building *glazing* complies with **3.12.2.1** with the applicable value for C_{SHGC} in **Table 3.12.2.1** reduced by 15%.

Explanatory information:

The attachment of a Class 10a building, such as a garage, glasshouse, solarium, pool enclosure or the like should not compromise the thermal performance of the Class 1 building. In addition, the Class 10a building may be insulated and so assist the Class 1 building achieve the *required* thermal performance.

The following are examples of a Class 1 building with an attached Class 10a garage.

In **(a)**, the thermal performance *required* for the Class 1 building may be achieved by the walls and floor of the Class 1 building as if the Class 10a garage is an under floor space with an enclosed perimeter.

In **(b)**, the thermal performance *required* for the Class 1 building may be achieved by the outside walls and floor of the Class 10a garage.

In **(c)**, in *climate zone* 5, the thermal performance of the Class 1 building may be achieved by ensuring that the roof of the Class 10a building satisfies **Table 3.12.1.1** and the walls are of masonry construction.

ENERGY EFFICIENCY

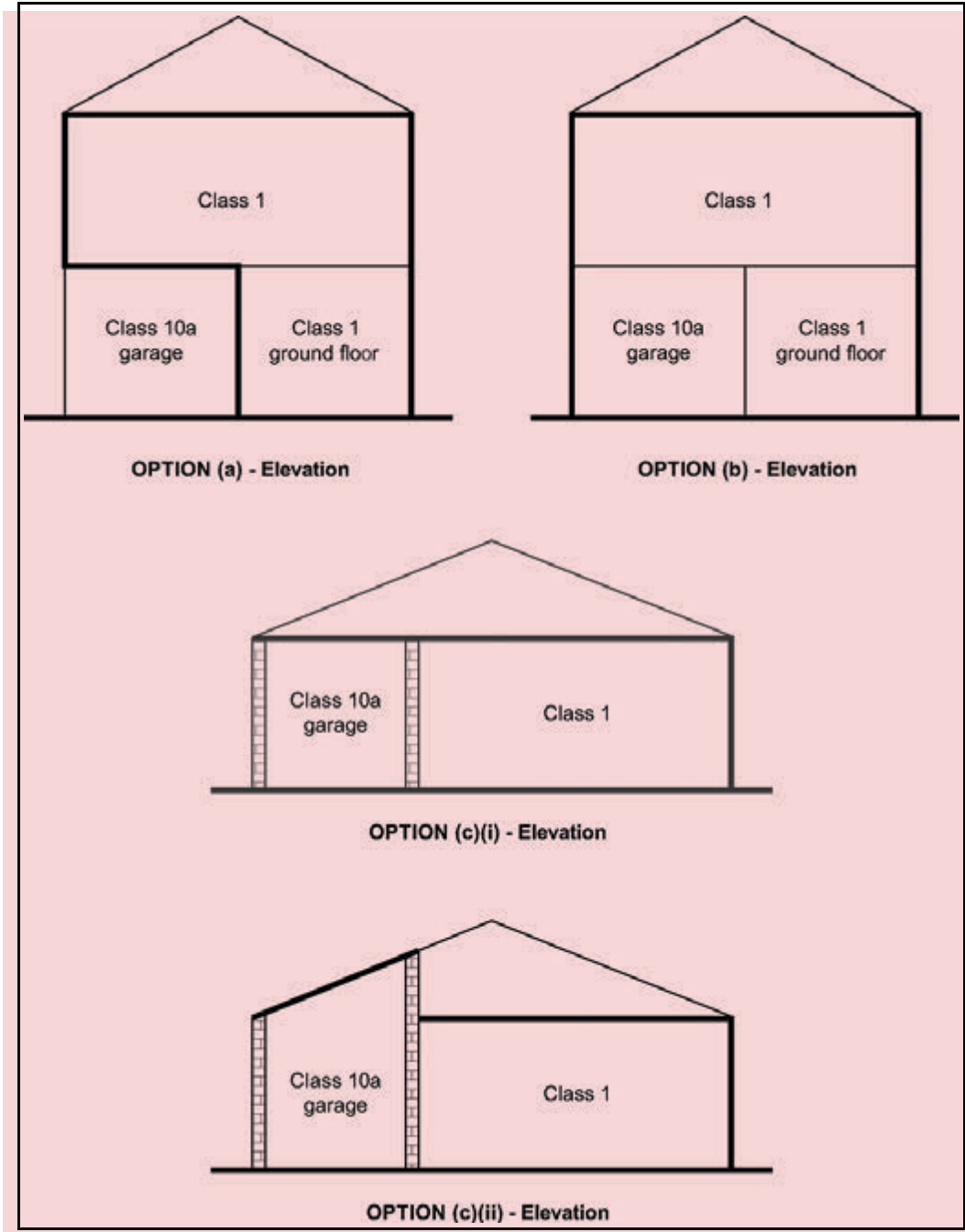

PART 3.12.2 EXTERNAL GLAZING

3.12.2 Application

This Part applies to—

- (a) a Class 1 building; and
- (b) a Class 10a building with a *conditioned space*.

Acceptable construction practice

3.12.2.1 External glazing

(a) The aggregate conductance of the *glazing* in each storey, including any mezzanine, of a building must—

- (i) not exceed the allowances resulting from—
 - (A) in *climate zone* 1, multiplying the area of the storey, including any mezzanine, measured within the enclosing walls, by the constant C_U obtained from **Table 3.12.2.1**; and
 - (B) in *climate zones* 2 to 8, using the constant C_U obtained from **Table 3.12.2.1**.

(ii) be calculated in accordance with the following calculation—

- (A) in *climate zone* 1—

$$(A_1 \times U_1) + (A_2 \times U_2) + (A_3 \times U_3) + \dots$$

where—

- $A_{1, 2, \text{etc}}$ = the area of each *glazing* element; and
- $U_{1, 2, \text{etc}}$ = the *Total System U-Value* of each *glazing* element; and

(B) in *climate zones* 2 to 8—

$$[(A_1 \times U_1) + (A_2 \times U_2) + \dots] / [(A_1 \times SHGC_1 \times E_{W1}) + (A_2 \times SHGC_2 \times E_{W2}) + \dots]$$

where—

- $A_{1, 2, \text{etc}}$ = the area of each *glazing* element; and
- $U_{1, 2, \text{etc}}$ = the *Total System U-Value* of each *glazing* element; and
- $SHGC_{1, 2, \text{etc}}$ = the *Total System SHGC* for each *glazing* element; and
- $E_{W1, W2 \text{ etc}}$ = the winter exposure factor for each *glazing* element obtained from **Table 3.12.2a**.

ENERGY EFFICIENCY

- (b) The aggregate solar heat gain of the *glazing* in each storey, including any mezzanine, of a building must—
- (i) not exceed the allowances resulting from multiplying the area of the storey, including any mezzanine, measured within the enclosing walls, by the constant C_{SHGC} obtained from [Table 3.12.2.1](#); and
 - (ii) be calculated in accordance with the following calculation—

$$(A_1 \times SHGC_1 \times E_{S1}) + (A_2 \times SHGC_2 \times E_{S2}) + \dots$$

where—

$A_{1, 2, \text{ etc}}$	=	the area of each <i>glazing</i> element; and
$SHGC_{1, 2, \text{ etc}}$	=	the <i>Total System SHGC</i> for each <i>glazing</i> element; and
$E_{S1, S2, \text{ etc}}$	=	the summer exposure factor for each <i>glazing</i> element obtained from Table 3.12.2.2b .

Explanatory information:

1. The conductance formula for *climate zone* 1 differs from the formula for all other *climate zones* because there is little or no need for heating at any time of the year in *climate zone* 1. The conductance allowance is calculated to limit the rate of heat conduction through *glazing* into an air conditioned interior from a hotter outside environment. The limit is set at a level that allows the use of basic *glazing* systems in dwellings with average *glazing* areas whether or not they are air conditioned.
2. The conductance formula for *climate zones* 2 to 8 is based on wintertime conditions to account for the balance between potential solar gains and heat loss by conduction through *glazing*. The calculation favours orientations with higher potential solar gains in winter and the use of shading rather than glass toning. The improved insulation performance of *glazing* resulting from the calculations will also be beneficial under summertime conditions when outside temperatures exceed inside temperatures.
3. By referring to "*glazing* elements", [3.12.2.1](#) requires *Total System U-Values* and *Total System SHGCs* to be assessed for the combined effect of glass and frames. The measurement of these *Total System U-Values* and *Total System SHGCs* is specified in the Technical Protocols and Procedures Manual for Energy Rating of Fenestration Products by the Australian Fenestration Rating Council (AFRC).
Various assessors using AFRC procedures might refer to their published performance values by slightly different terms including "U-factor" or "Uw" for *Total System U-Value* or "SHGC" for *Total System SHGC*. Such values can be used under [3.12.2.1](#) provided they measure the combined glass and frame performance according to AFRC requirements.
4. *Total System U-Values* and *Total System SHGCs* are shown for some simple types of *glazing* elements in the table below (smaller numbers indicate better *glazing* element performance). The table gives worst case assessments, which can be improved by obtaining generic or custom product assessments from suppliers, manufacturers, industry associations (including their online resources) and from competent assessors.

ENERGY EFFICIENCY

WORST CASE WHOLE GLAZING ELEMENT PERFORMANCE VALUES				
Glass description	Aluminium framing		Timber or uPVC framing	
	<i>Total System U-Value</i>	<i>Total System SHGC</i>	<i>Total System U-Value</i>	<i>Total System SHGC</i>
Single clear	7.9	0.81	5.6	0.77
Tinted single	7.9	0.65	5.6	0.61
Clear double (3/6/3)	6.2	0.72	3.8	0.68

5. Typical ranges of generic ratings are set out in the table below to illustrate the levels of performance available through such assessments. Numbers from this table should not be used in compliance calculations.

INDICATIVE RANGES OF WHOLE GLAZING ELEMENT PERFORMANCE VALUES					
Glass description	Comment	Aluminium framing		Timber or uPVC framing	
		<i>Total System U-Value range</i>	<i>Total System SHGC range</i>	<i>Total System U-Value range</i>	<i>Total System SHGC range</i>
Single (monolithic or laminated)					
Clear	Minimal variation in glass U-Value and SHGC for different glass thicknesses.	7.9 - 5.5	0.81 - 0.64	5.6 - 4.3	0.77 - 0.51
Tinted	Glass SHGC depends on glass thickness and type of tint.	7.9 - 5.6	0.65 - 0.33	5.6 - 4.3	0.61 - 0.25
Coated	Glass U-Value and SHGC depend on coating type.	7.8 - 3.8	0.68 - 0.36	5.5 - 2.9	0.64 - 0.27
Tinted + coated	Glass U-Value depends on coating type. Glass SHGC depends on coating type, type of tint and glass thickness.	7.8 - 3.8	0.45 - 0.31	5.5 - 3.1	0.42 - 0.23
Double					
Clear	Glass U-Value depends on cavity width.	6.2 - 3.1	0.72 - 0.63	3.8 - 2.5	0.68 - 0.47
Tinted	Glass U-Value depends on cavity width. Glass SHGC depends on type of tint, tinted glass thickness and on cavity width.	6.2 - 3.1	0.57 - 0.36	3.8 - 2.5	0.57 - 0.27

ENERGY EFFICIENCY

INDICATIVE RANGES OF WHOLE GLAZING ELEMENT PERFORMANCE VALUES					
Glass description	Comment	Aluminium framing		Timber or uPVC framing	
		Total System U-Value range	Total System SHGC range	Total System U-Value range	Total System SHGC range
Coated	Glass U-Value depends on cavity width and type of coating. Glass SHGC depends on type of coating and cavity width.	6.1 – 2.4	0.60 – 0.22	3.8 – 2.1	0.59 – 0.17
Tinted + Coated	Glass U-Value depends on cavity width and type of coating. Glass SHGC depends on type of coating, tinted glass thickness and cavity width.	6.1 – 2.5	0.41 – 0.21	3.8 – 2.1	0.37 – 0.16

6. Custom assessments consider *glazing* element components in most detail and return the highest levels of assessed performance for a given type of *glazing* element. Generic assessments consider the components of *glazing* elements in less detail and return lower levels of assessed performance.
7. The calculations for conductance and solar heat gain both consider seasonal solar radiation, orientation, shading and the solar performance of the *glazing*.

Table 3.12.2.1 CONSTANTS FOR CONDUCTANCE AND SOLAR HEAT GAIN

Floor construction	Air Movement (refer Notes)	Constant	Climate zone							
			1	2	3	4	5	6	7	8
Floor in direct contact with the ground	Standard	C_U	1.650	18.387	14.641	7.929	13.464	6.418	5.486	3.987
		C_{SHGC}	0.063	0.074	0.062	0.097	0.122	0.153	0.189	0.234
	High	C_U	1.650	18.387	14.641	7.929	13.464	6.418	5.486	3.987
		C_{SHGC}	0.069	0.081	0.068	0.107	0.134	0.168	0.208	0.257
Suspended floor	Standard	C_U	1.485	16.548	13.177	7.136	12.118	5.776	4.937	3.588
		C_{SHGC}	0.057	0.067	0.056	0.087	0.110	0.138	0.170	0.211
	High	C_U	1.485	16.548	13.177	7.136	12.118	5.776	4.937	3.588
		C_{SHGC}	0.063	0.074	0.062	0.096	0.121	0.152	0.187	0.232

Notes:

- A storey has Standard air movement if all *habitable rooms* comply with **Part 3.12.4**.
- A storey has High air movement if the total *ventilation opening* area serving the *habitable room* is—
 - in *climate zones* 1, 2, 3, 4 and 5, not less than that for Standard air movement without a ceiling fan or evaporative cooler, but with ceiling fans complying with **3.12.4.3** installed in all *habitable rooms*; or
 - not less than twice that for Standard air movement without a ceiling fan or evaporative cooler.
- Where the *ventilation opening* area serving the *habitable rooms* is between Standard and High, interpolation may be used to determine the applicable C_{SHGC} .
- Where the floor construction of a storey, including a mezzanine, is partly in direct contact with the ground and partly suspended, the constants for conductance and solar heat gain are to be—
 - interpolated between the constants for the two constructions in proportion to their respective areas; or
 - those for a suspended floor.

ENERGY EFFICIENCY

Explanatory information:

1. A floor in direct contact with the ground includes a concrete slab-on-ground or concrete slab-on-fill.
2. A suspended floor includes a suspended timber floor, suspended steel framed floor or suspended concrete floor.
3. In general, a floor in direct contact with the ground more readily assimilates solar heat gains than a suspended floor. Consequently, lower stringency levels apply to *glazing* in a storey that has a floor in direct contact with the ground.
4. Whether a storey has Standard or High air movement depends upon the total *ventilation opening* area provided to *habitable rooms* on that storey and the presence of ceiling fans. The additional *ventilation opening* area *required* for High air movement without fans can be distributed to any of the *habitable rooms* on the storey. In *climate zones* 1 to 5, the storey can achieve High air movement when the total *ventilation opening* area is as for Standard air movement (without a ceiling fan or evaporative cooler) but with ceiling fans installed in every *habitable room*. For example, in *climate zone* 2:

Air movement	With ceiling fans	Without ceiling fans
Standard	10%	7.5%
High	20%	10%

5. The provisions of 3.12.2 assume that internal *window* coverings will be installed for privacy reasons. This assumption is already incorporated in the allowances for *glazing*.

Table 3.12.2.2a WINTER EXPOSURE FACTOR (E_w)

P/H (refer Figure 3.12.2.2)	Orientation Sector (refer Figure 3.12.2.1)							
	North	North east	East	South east	South	South west	West	North west
CLIMATE ZONE 1								
Winter exposure factors are not needed for <i>climate zone</i> 1.								
CLIMATE ZONE 2								
0.00	1.86	1.44	0.86	0.40	0.37	0.41	0.91	1.48
0.05	1.80	1.37	0.80	0.34	0.31	0.36	0.84	1.42
0.10	1.73	1.33	0.76	0.32	0.29	0.34	0.81	1.34
0.20	1.51	1.18	0.68	0.29	0.27	0.30	0.73	1.20
0.40	1.25	0.95	0.54	0.24	0.23	0.25	0.61	0.99
0.60	1.04	0.78	0.48	0.21	0.20	0.22	0.51	0.83
0.80	0.78	0.62	0.39	0.18	0.19	0.20	0.44	0.68
1.00	0.54	0.53	0.32	0.17	0.18	0.17	0.37	0.56
1.20	0.33	0.42	0.28	0.15	0.17	0.16	0.35	0.46
1.40	0.28	0.36	0.23	0.14	0.16	0.15	0.31	0.38
1.60	0.22	0.29	0.22	0.14	0.15	0.14	0.26	0.34
1.80	0.19	0.25	0.19	0.13	0.14	0.13	0.23	0.28

ENERGY EFFICIENCY

Table 3.12.2.2a WINTER EXPOSURE FACTOR (E_w)— continued

P/H (refer Figure 3.12.2.2)	Orientation Sector (refer Figure 3.12.2.1)							
	North	North east	East	South east	South	South west	West	North west
2.00	0.15	0.19	0.17	0.12	0.14	0.13	0.22	0.27
CLIMATE ZONE 3								
0.00	1.92	1.49	0.88	0.32	0.25	0.33	0.95	1.56
0.05	1.90	1.44	0.82	0.28	0.22	0.29	0.91	1.52
0.10	1.76	1.37	0.87	0.27	0.21	0.28	0.87	1.44
0.20	1.57	1.22	0.70	0.24	0.20	0.25	0.78	1.30
0.40	1.25	1.00	0.60	0.20	0.18	0.21	0.67	1.08
0.60	0.94	0.77	0.48	0.18	0.17	0.18	0.54	0.87
0.80	0.63	0.61	0.43	0.16	0.15	0.17	0.46	0.70
1.00	0.42	0.52	0.35	0.14	0.14	0.16	0.41	0.56
1.20	0.29	0.40	0.31	0.13	0.14	0.14	0.34	0.48
1.40	0.23	0.36	0.25	0.12	0.13	0.13	0.30	0.41
1.60	0.17	0.31	0.24	0.11	0.12	0.12	0.29	0.34
1.80	0.15	0.22	0.19	0.11	0.12	0.11	0.24	0.31
2.00	0.13	0.22	0.18	0.10	0.12	0.11	0.22	0.27
CLIMATE ZONE 4								
0.00	1.97	1.51	0.83	0.39	0.35	0.39	0.85	1.53
0.05	1.93	1.45	0.76	0.33	0.29	0.33	0.79	1.47
0.10	1.91	1.40	0.74	0.31	0.28	0.31	0.75	1.42
0.20	1.62	1.28	0.67	0.28	0.25	0.28	0.68	1.28
0.40	1.48	1.09	0.56	0.24	0.22	0.24	0.58	1.10
0.60	1.22	0.90	0.49	0.21	0.19	0.21	0.49	0.90
0.80	1.06	0.74	0.43	0.19	0.18	0.19	0.44	0.75
1.00	0.85	0.66	0.37	0.17	0.16	0.17	0.37	0.64
1.20	0.61	0.51	0.33	0.15	0.16	0.16	0.34	0.56
1.40	0.47	0.47	0.30	0.14	0.15	0.15	0.30	0.47
1.60	0.34	0.41	0.28	0.14	0.14	0.14	0.26	0.41
1.80	0.26	0.35	0.25	0.13	0.14	0.13	0.24	0.35
2.00	0.24	0.32	0.22	0.12	0.13	0.12	0.22	0.29
CLIMATE ZONE 5								
0.00	2.01	1.48	0.77	0.39	0.37	0.39	0.85	1.58
0.05	1.95	1.42	0.70	0.33	0.31	0.33	0.78	1.51

ENERGY EFFICIENCY

Table 3.12.2.2a WINTER EXPOSURE FACTOR (E_w)— continued

P/H (refer Figure 3.12.2.2)	Orientation Sector (refer Figure 3.12.2.1)							
	North	North east	East	South east	South	South west	West	North west
0.10	1.95	1.36	0.66	0.31	0.30	0.32	0.75	1.47
0.20	1.63	1.21	0.59	0.28	0.27	0.28	0.67	1.32
0.40	1.49	1.00	0.49	0.24	0.23	0.24	0.55	1.10
0.60	1.21	0.83	0.40	0.21	0.21	0.21	0.47	0.90
0.80	0.98	0.68	0.35	0.19	0.19	0.19	0.42	0.73
1.00	0.80	0.52	0.28	0.17	0.18	0.17	0.36	0.63
1.20	0.54	0.46	0.25	0.16	0.17	0.16	0.29	0.50
1.40	0.40	0.34	0.21	0.15	0.16	0.15	0.28	0.43
1.60	0.28	0.30	0.19	0.14	0.14	0.13	0.23	0.36
1.80	0.22	0.25	0.16	0.13	0.14	0.13	0.20	0.32
2.00	0.18	0.19	0.15	0.12	0.14	0.12	0.19	0.24
CLIMATE ZONE 6								
0.00	1.90	1.43	0.80	0.45	0.43	0.45	0.88	1.53
0.05	1.84	1.35	0.73	0.38	0.36	0.38	0.81	1.45
0.10	1.82	1.30	0.70	0.36	0.34	0.36	0.76	1.42
0.20	1.56	1.17	0.62	0.32	0.30	0.32	0.70	1.30
0.40	1.43	1.01	0.53	0.27	0.26	0.27	0.60	1.10
0.60	1.22	0.86	0.45	0.23	0.23	0.23	0.52	0.95
0.80	1.08	0.73	0.38	0.21	0.21	0.22	0.46	0.79
1.00	0.86	0.58	0.34	0.19	0.19	0.19	0.39	0.69
1.20	0.70	0.54	0.29	0.18	0.17	0.18	0.36	0.58
1.40	0.53	0.41	0.26	0.16	0.17	0.17	0.32	0.52
1.60	0.44	0.37	0.22	0.15	0.16	0.15	0.28	0.44
1.80	0.32	0.30	0.21	0.14	0.15	0.14	0.27	0.40
2.00	0.25	0.27	0.20	0.13	0.14	0.14	0.24	0.32
CLIMATE ZONE 7								
0.00	2.08	1.63	0.83	0.38	0.35	0.38	0.75	1.50
0.05	2.01	1.56	0.77	0.32	0.29	0.32	0.69	1.44
0.10	2.01	1.53	0.73	0.30	0.28	0.30	0.66	1.41
0.20	1.89	1.43	0.68	0.27	0.25	0.27	0.60	1.28
0.40	1.62	1.24	0.58	0.23	0.21	0.23	0.50	1.13
0.60	1.49	1.09	0.50	0.20	0.19	0.20	0.44	0.96

ENERGY EFFICIENCY

Table 3.12.2.2a WINTER EXPOSURE FACTOR (E_w)— continued

P/H (refer Figure 3.12.2.2)	Orientation Sector (refer Figure 3.12.2.1)							
	North	North east	East	South east	South	South west	West	North west
0.80	1.27	0.94	0.44	0.18	0.17	0.18	0.39	0.83
1.00	1.16	0.83	0.41	0.16	0.16	0.16	0.34	0.71
1.20	0.91	0.70	0.34	0.15	0.15	0.15	0.30	0.63
1.40	0.83	0.68	0.33	0.14	0.14	0.14	0.27	0.48
1.60	0.64	0.49	0.30	0.13	0.13	0.12	0.25	0.45
1.80	0.52	0.47	0.24	0.12	0.13	0.12	0.23	0.39
2.00	0.39	0.39	0.24	0.11	0.12	0.12	0.20	0.33
CLIMATE ZONE 8								
0.00	1.93	1.48	0.81	0.47	0.45	0.47	0.81	1.46
0.05	1.87	1.41	0.73	0.39	0.38	0.39	0.73	1.39
0.10	1.85	1.36	0.70	0.37	0.35	0.37	0.70	1.34
0.20	1.56	1.22	0.63	0.33	0.32	0.33	0.63	1.20
0.40	1.41	1.02	0.51	0.28	0.27	0.28	0.51	0.99
0.60	1.18	0.83	0.44	0.24	0.24	0.24	0.44	0.82
0.80	1.00	0.68	0.37	0.21	0.22	0.21	0.36	0.67
1.00	0.79	0.59	0.32	0.20	0.20	0.19	0.30	0.58
1.20	0.54	0.46	0.28	0.18	0.19	0.18	0.27	0.47
1.40	0.44	0.42	0.25	0.17	0.18	0.17	0.24	0.38
1.60	0.31	0.31	0.21	0.16	0.17	0.15	0.22	0.32
1.80	0.23	0.28	0.19	0.14	0.16	0.14	0.19	0.29
2.00	0.19	0.25	0.16	0.14	0.15	0.14	0.17	0.23

Note: For exposure factors with P/H values between those shown in Table 3.12.2.2a, either use the next highest P/H value or interpolate.

Table 3.12.2.2b SUMMER EXPOSURE FACTOR (E_s)

P/H (refer Figure 3.12.2.2)	Orientation Sector (refer Figure 3.12.2.1)							
	North	North east	East	South east	South	South west	West	North west
CLIMATE ZONE 1								
0.00	0.52	0.84	1.29	1.24	0.87	1.27	1.32	0.85
0.05	0.44	0.74	1.19	1.13	0.75	1.17	1.23	0.75
0.10	0.41	0.68	1.11	1.07	0.68	1.09	1.15	0.69
0.20	0.37	0.59	1.01	0.94	0.55	0.94	1.00	0.60

ENERGY EFFICIENCY

Table 3.12.2.2b SUMMER EXPOSURE FACTOR (E_s) — continued

P/H (refer Figure 3.12.2.2)	Orientation Sector (refer Figure 3.12.2.1)							
	North	North east	East	South east	South	South west	West	North west
0.40	0.30	0.45	0.79	0.69	0.42	0.75	0.83	0.47
0.60	0.25	0.37	0.66	0.59	0.34	0.60	0.66	0.38
0.80	0.22	0.31	0.53	0.47	0.30	0.52	0.58	0.32
1.00	0.19	0.26	0.45	0.41	0.25	0.43	0.48	0.28
1.20	0.18	0.23	0.37	0.33	0.22	0.39	0.42	0.26
1.40	0.17	0.21	0.32	0.30	0.22	0.32	0.37	0.22
1.60	0.15	0.18	0.28	0.26	0.18	0.29	0.34	0.21
1.80	0.13	0.18	0.27	0.22	0.17	0.28	0.30	0.18
2.00	0.12	0.17	0.23	0.21	0.16	0.24	0.28	0.17
CLIMATE ZONE 2								
0.00	0.72	1.05	1.22	1.04	0.72	1.12	1.34	1.11
0.05	0.60	0.92	1.10	0.92	0.60	1.01	1.23	0.99
0.10	0.55	0.85	1.04	0.86	0.57	0.94	1.14	0.90
0.20	0.47	0.74	0.92	0.76	0.50	0.84	1.00	0.78
0.40	0.39	0.56	0.73	0.61	0.40	0.67	0.83	0.60
0.60	0.33	0.44	0.60	0.49	0.33	0.55	0.67	0.45
0.80	0.29	0.37	0.50	0.41	0.29	0.46	0.58	0.39
1.00	0.26	0.30	0.43	0.35	0.24	0.40	0.47	0.32
1.20	0.23	0.27	0.35	0.30	0.22	0.34	0.41	0.28
1.40	0.21	0.24	0.32	0.28	0.21	0.30	0.36	0.24
1.60	0.19	0.23	0.28	0.25	0.19	0.27	0.31	0.22
1.80	0.17	0.20	0.24	0.22	0.17	0.26	0.28	0.20
2.00	0.17	0.19	0.22	0.21	0.16	0.22	0.27	0.19
CLIMATE ZONE 3								
0.00	0.56	1.04	1.42	1.18	0.66	1.16	1.36	1.01
0.05	0.47	0.94	1.32	1.08	0.57	1.05	1.26	0.90
0.10	0.44	0.85	1.25	1.02	0.54	0.99	1.19	0.83
0.20	0.38	0.73	1.10	0.90	0.46	0.87	1.06	0.73
0.40	0.32	0.56	0.88	0.71	0.38	0.72	0.84	0.56
0.60	0.28	0.43	0.74	0.58	0.31	0.57	0.71	0.44
0.80	0.24	0.35	0.59	0.47	0.27	0.50	0.60	0.35
1.00	0.20	0.29	0.50	0.40	0.24	0.43	0.53	0.29

ENERGY EFFICIENCY

Table 3.12.2.2b SUMMER EXPOSURE FACTOR (E_s) — continued

P/H (refer Figure 3.12.2.2)	Orientation Sector (refer Figure 3.12.2.1)							
	North	North east	East	South east	South	South west	West	North west
1.20	0.19	0.26	0.42	0.34	0.21	0.37	0.43	0.26
1.40	0.17	0.22	0.35	0.31	0.20	0.32	0.41	0.23
1.60	0.17	0.20	0.33	0.27	0.16	0.31	0.35	0.21
1.80	0.15	0.19	0.30	0.24	0.16	0.28	0.33	0.19
2.00	0.15	0.18	0.25	0.24	0.15	0.24	0.27	0.17
CLIMATE ZONE 4								
0.00	0.72	1.19	1.40	1.05	0.57	0.99	1.31	1.12
0.05	0.61	1.10	1.31	0.97	0.49	0.91	1.22	1.02
0.10	0.56	1.00	1.24	0.91	0.46	0.85	1.17	0.94
0.20	0.43	0.87	1.12	0.82	0.41	0.76	1.05	0.81
0.40	0.30	0.66	0.92	0.67	0.34	0.62	0.85	0.62
0.60	0.27	0.50	0.74	0.56	0.29	0.53	0.72	0.45
0.80	0.24	0.38	0.63	0.49	0.25	0.45	0.59	0.36
1.00	0.20	0.31	0.55	0.42	0.22	0.39	0.51	0.30
1.20	0.19	0.26	0.46	0.37	0.20	0.35	0.45	0.25
1.40	0.16	0.23	0.39	0.34	0.17	0.33	0.38	0.21
1.60	0.16	0.20	0.38	0.30	0.16	0.29	0.33	0.20
1.80	0.14	0.18	0.32	0.27	0.14	0.25	0.32	0.17
2.00	0.13	0.17	0.28	0.23	0.14	0.24	0.26	0.16
CLIMATE ZONE 5								
0.00	0.82	1.09	1.19	0.96	0.68	1.04	1.30	1.16
0.05	0.69	0.96	1.07	0.85	0.57	0.92	1.19	1.04
0.10	0.63	0.88	1.01	0.79	0.54	0.86	1.11	0.94
0.20	0.51	0.76	0.89	0.70	0.48	0.76	0.99	0.83
0.40	0.39	0.58	0.71	0.57	0.38	0.62	0.81	0.62
0.60	0.35	0.46	0.58	0.47	0.33	0.51	0.65	0.48
0.80	0.30	0.37	0.50	0.40	0.28	0.43	0.52	0.40
1.00	0.26	0.31	0.42	0.34	0.25	0.37	0.46	0.31
1.20	0.24	0.26	0.36	0.30	0.22	0.33	0.40	0.27
1.40	0.21	0.23	0.32	0.27	0.20	0.29	0.34	0.24
1.60	0.20	0.22	0.29	0.23	0.18	0.27	0.30	0.21
1.80	0.18	0.20	0.25	0.21	0.17	0.23	0.27	0.20

ENERGY EFFICIENCY

Table 3.12.2.2b SUMMER EXPOSURE FACTOR (E_s) — continued

P/H (refer Figure 3.12.2.2)	Orientation Sector (refer Figure 3.12.2.1)							
	North	North east	East	South east	South	South west	West	North west
2.00	0.17	0.17	0.24	0.21	0.16	0.21	0.25	0.19
CLIMATE ZONE 6								
0.00	0.84	1.08	1.15	0.87	0.61	1.05	1.40	1.24
0.05	0.71	0.97	1.05	0.78	0.52	0.96	1.30	1.13
0.10	0.65	0.90	0.99	0.74	0.49	0.91	1.25	1.04
0.20	0.52	0.77	0.88	0.65	0.44	0.82	1.12	0.91
0.40	0.36	0.58	0.71	0.54	0.36	0.67	0.90	0.69
0.60	0.30	0.43	0.61	0.45	0.31	0.58	0.76	0.51
0.80	0.26	0.35	0.50	0.38	0.26	0.50	0.66	0.40
1.00	0.22	0.29	0.42	0.32	0.23	0.42	0.56	0.36
1.20	0.20	0.24	0.37	0.29	0.23	0.39	0.48	0.29
1.40	0.18	0.22	0.32	0.26	0.19	0.34	0.42	0.26
1.60	0.16	0.19	0.28	0.24	0.18	0.31	0.38	0.21
1.80	0.15	0.18	0.26	0.22	0.17	0.28	0.34	0.20
2.00	0.14	0.17	0.24	0.21	0.17	0.26	0.31	0.17
CLIMATE ZONE 7								
0.00	0.96	1.17	1.21	0.94	0.64	0.91	1.19	1.18
0.05	0.83	1.05	1.10	0.83	0.54	0.81	1.09	1.07
0.10	0.76	0.97	1.04	0.80	0.51	0.76	1.03	0.98
0.20	0.62	0.85	0.93	0.70	0.45	0.68	0.91	0.86
0.40	0.40	0.65	0.76	0.58	0.38	0.55	0.74	0.64
0.60	0.32	0.51	0.65	0.50	0.33	0.47	0.63	0.51
0.80	0.28	0.40	0.54	0.44	0.28	0.41	0.53	0.40
1.00	0.25	0.33	0.48	0.37	0.25	0.35	0.44	0.32
1.20	0.22	0.28	0.41	0.34	0.23	0.31	0.38	0.27
1.40	0.19	0.23	0.36	0.30	0.21	0.28	0.33	0.24
1.60	0.18	0.21	0.33	0.27	0.20	0.26	0.31	0.21
1.80	0.17	0.20	0.28	0.24	0.18	0.24	0.27	0.19
2.00	0.16	0.19	0.27	0.23	0.18	0.21	0.25	0.18
CLIMATE ZONE 8								
0.00	0.85	1.12	1.20	0.96	0.68	1.01	1.27	1.16
0.05	0.71	0.99	1.09	0.85	0.57	0.90	1.16	1.04

ENERGY EFFICIENCY

Table 3.12.2.2b SUMMER EXPOSURE FACTOR (E_S) — continued

P/H (refer Figure 3.12.2.2)	Orientation Sector (refer Figure 3.12.2.1)							
	North	North east	East	South east	South	South west	West	North west
0.10	0.65	0.90	1.02	0.79	0.54	0.84	1.09	0.95
0.20	0.52	0.79	0.90	0.70	0.48	0.73	0.98	0.83
0.40	0.39	0.60	0.73	0.57	0.39	0.61	0.79	0.63
0.60	0.34	0.46	0.60	0.48	0.33	0.50	0.66	0.49
0.80	0.30	0.37	0.50	0.41	0.29	0.43	0.53	0.40
1.00	0.25	0.30	0.42	0.35	0.25	0.37	0.47	0.33
1.20	0.23	0.28	0.37	0.31	0.23	0.33	0.39	0.26
1.40	0.21	0.23	0.32	0.29	0.20	0.29	0.34	0.24
1.60	0.20	0.21	0.30	0.25	0.18	0.25	0.31	0.22
1.80	0.19	0.20	0.25	0.22	0.17	0.23	0.28	0.20
2.00	0.16	0.18	0.23	0.21	0.16	0.22	0.24	0.19

Note: For exposure factors with P/H values between those shown in Table 3.12.2.2b, either use the next lowest P/H value or interpolate.

Explanatory information:

1. Higher exposure factor (E_W) values in Table 3.12.2.2a indicate greater exposure to desirable winter solar gains and should be adopted as far as possible.
2. Higher exposure factor (E_S) values in Table 3.12.2.2b indicate greater exposure to unwanted summer solar gains and should be avoided as far as possible.

ENERGY EFFICIENCY

Figure 3.12.2.1

ORIENTATION SECTORS

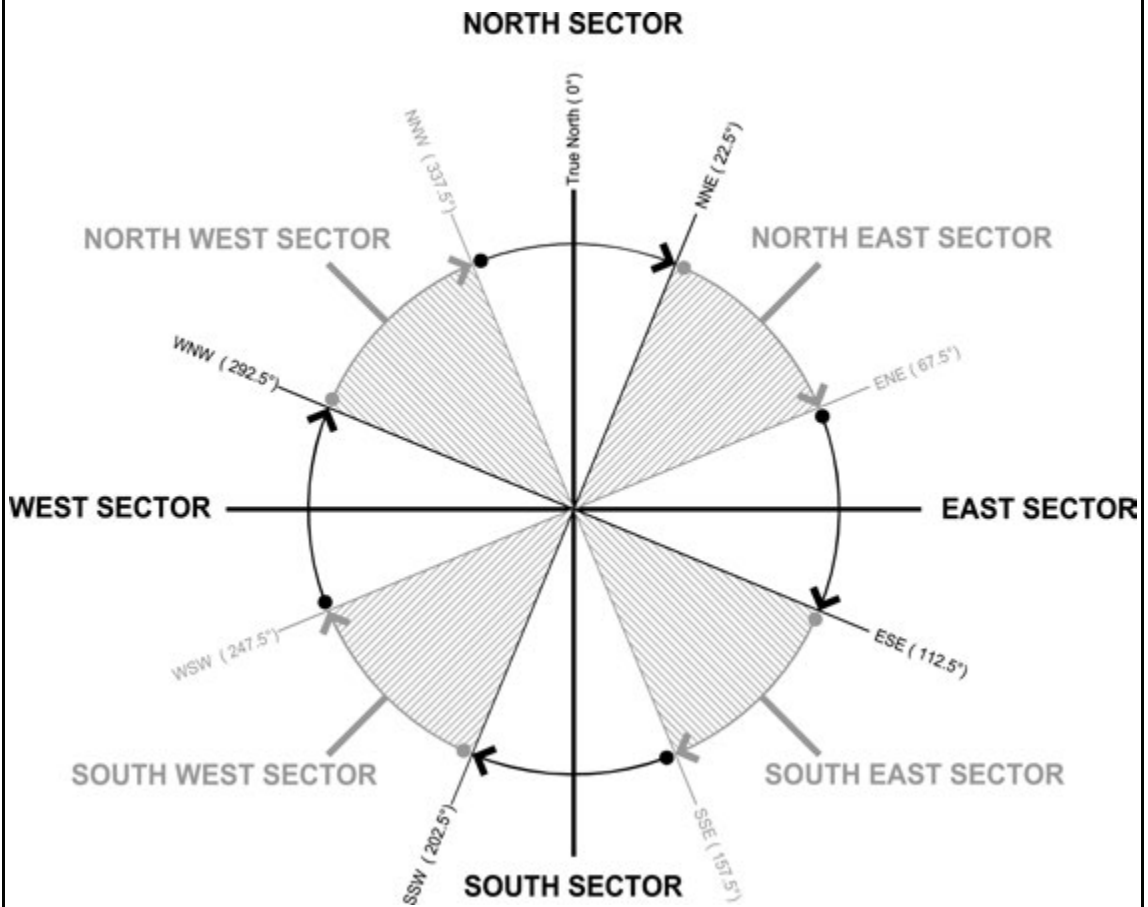
**Explanatory information:**

1. The orientation sector for a wall or *glazing* element is the sector that contains a line drawn perpendicular to the face of the wall or *glazing* element.
2. **Figure 3.12.2.1** is based on True North and all angles are measured clockwise from True North. Survey angles on site plans are usually marked in angles from True North. These angles can be used to establish True North for a particular site.
3. Magnetic North, found by a magnetic compass, varies from True North over time and by different amounts in different locations. Magnetic North is not an acceptable approximation of True North.
4. The eight orientation sectors shown in **Figure 3.12.2.1** do not overlap at their boundaries. For example, North sector begins just clockwise after the NNW line and ends exactly on the NNE line. The start and end of other sectors are determined in a similar way, as indicated by the outer curved arrows.

ENERGY EFFICIENCY

Figure 3.12.2.2

METHOD OF MEASURING P AND H

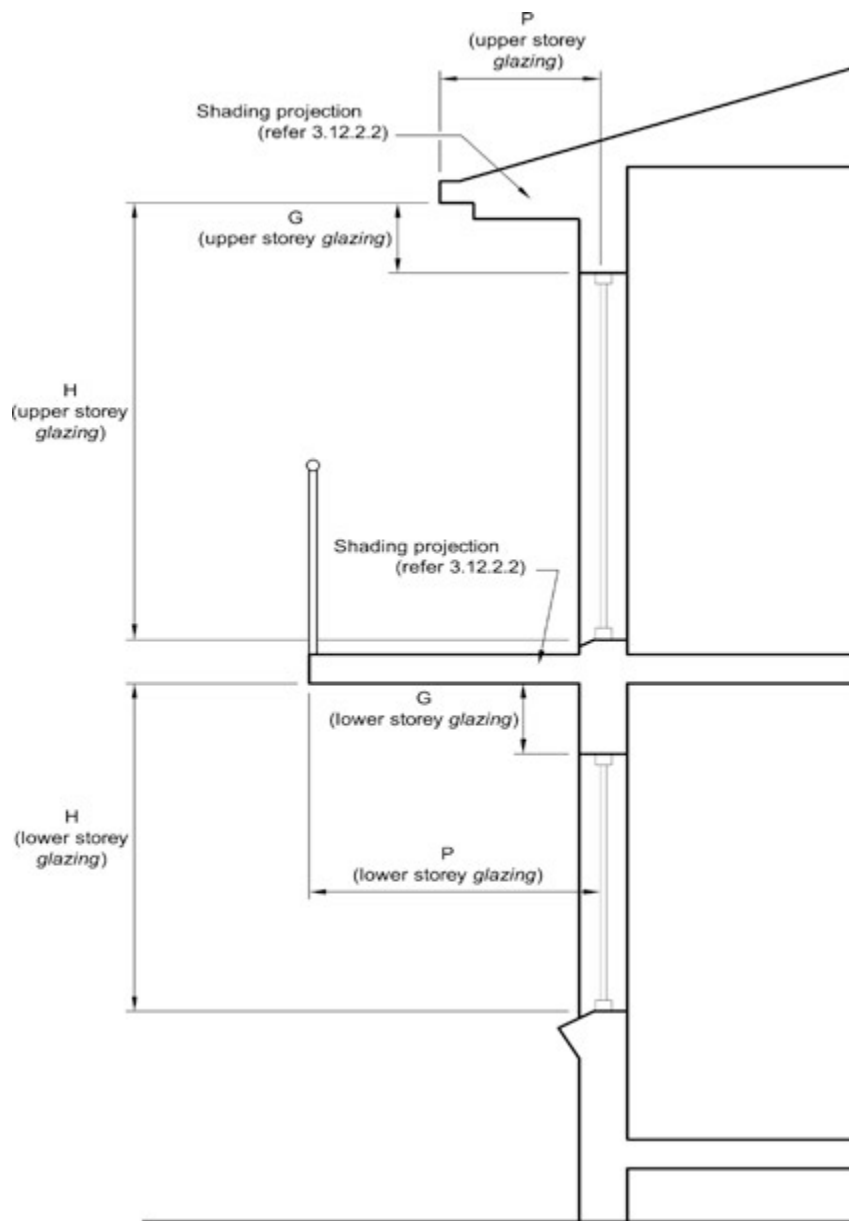
**Notes:**

1. An external shading device that complies with 3.12.2.2(b) is considered to achieve a P/H value of 2.00.
2. Where G exceeds 500 mm, the value of P must be halved.

3.12.2.2 Shading

Where shading is *required* to comply with 3.12.2.1, it must—

ENERGY EFFICIENCY

- (a) be provided by an external permanent projection, such as a verandah, balcony, fixed canopy, eaves, shading hood or carport, which—
 - (i) extends horizontally on both sides of the *glazing* for a distance not less than the projection distance P in **Figure 3.12.2.2**; or
 - (ii) provide the equivalent shading to (i) with a reveal or the like; or
- (b) be provided by an external shading device, such as a shutter, blind, vertical or horizontal building screen with blades, battens or slats, which—
 - (i) is capable of restricting at least 80% of the summer solar radiation; and
 - (ii) if adjustable, is readily operated either manually, mechanically or electronically by the building occupants.

Explanatory information:

1. Shading devices can include fixed louvres, shading screens and other types of perforated or fixed angle slatted shades. However, such devices need to be designed for the climate and latitude to ensure that summer sun penetration is restricted, while winter sun access is achieved. Winter access refers to the availability of winter solar gains to offset conducted heat losses.
2. The impact of shading is assessed with respect to the solar heat gain for the *window*. The requirements of **3.12.2.1** considers solar heat gain to be either beneficial or detrimental to the energy efficiency of a building based on seasonal variation (winter/summer), *climate zone*, orientation and P/H. Higher P/H values are more beneficial in minimising summer solar heat gain where as lower P/H values are more beneficial in allowing winter access.
3. Gutters can only be considered as providing shading if attached to a shading projection such as a verandah, fixed canopy, eaves, shading hood, balcony or the like.
4. Shading devices can be either attached or located adjacent to the building. For example, a free-standing lattice screen may be considered to provide shading to *glazing* if it complies with **3.12.2.2(b)**.

PART 3.12.3 BUILDING SEALING

3.12.3 Application

- (a) This Part applies to—
- (i) a Class 1 building; and
 - (ii) a Class 10a building with a *conditioned space*.
- (b) The provisions of (a) do not apply to the following:
- (i) A building in *climate zones* 1, 2, 3 and 5 where the only means of air-conditioning is by using an evaporative cooler.
 - (ii) A permanent building *ventilation opening* that is necessary for the safe operation of a gas appliance.
 - (iii) A Class 10a building used for the accommodation of vehicles.

Explanatory information:

1. An evaporatively cooled building in *climate zones* 4 and 6 needs to be sealed because of the likelihood of heating being needed during colder periods.
2. Appropriate ventilation for gas appliances can be obtained from relevant legislation, reference standards and product installation manuals.

Acceptable construction practice

3.12.3.1 Chimneys and flues

The chimney or flue of an open solid-fuel burning appliance must be provided with a damper or flap that can be closed to seal the chimney or flue.

Explanatory information:

1. The requirements of this Part are to be read in conjunction with the fire safety requirements in **Part 3.7.3**.
2. A solid-fuel burning device is a heater that burns material such as timber, coal and the like. This clause does not apply to gas and liquid fuel burning devices.

3.12.3.2 Roof lights

- (a) A *roof light* must be sealed, or capable of being sealed, when serving—
- (i) a *conditioned space*; or
 - (ii) a *habitable room* in *climate zones* 4, 5, 6, 7 and 8.
- (b) A *roof light required* by (a) to be sealed, or capable of being sealed, must be constructed with—

ENERGY EFFICIENCY

- (i) an imperforate ceiling diffuser or the like installed at the ceiling or internal lining level; or
- (ii) a weatherproof seal; or
- (iii) a shutter system readily operated either manually, mechanically or electronically by the occupant.

3.12.3.3 External windows and doors

- (a) A seal to restrict air infiltration must be fitted to each edge of an external door, openable *window* and other such opening—
 - (i) when serving a *conditioned space*; or
 - (ii) in *climate zones* 4, 5, 6, 7 and 8, when serving a *habitable room*.
- (b) A *window* complying with the maximum air infiltration rates specified in AS 2047 need not comply with (a).
- (c) A seal *required* by (a)—
 - (i) for the bottom edge of an external swing door, must be a draft protection device; and
 - (ii) for the other edges of an external swing door or the edges of an openable *window* or other such opening, may be a foam or rubber compressible strip, fibrous seal or the like.

3.12.3.4 Exhaust fans

An exhaust fan must be fitted with a sealing device such as a self-closing damper, filter or the like when serving—

- (a) a *conditioned space*; or
- (b) a *habitable room* in *climate zones* 4, 5, 6, 7 and 8.

Explanatory information:

An exhaust fan is considered to be adequately sealed if it is fitted with a filter such as the type commonly used in kitchen range hoods.

3.12.3.5 Construction of roofs, walls and floors

- (a) Roofs, *external walls*, external floors and any opening such as a *window* frame, door frame, *roof light* frame or the like must be constructed to minimise air leakage in accordance with (b) when forming part of the external *fabric* of—
 - (i) a *conditioned space*; or
 - (ii) a *habitable room* in *climate zones* 4, 5, 6, 7 and 8.
- (b) Construction *required* by (a) must be—
 - (i) enclosed by internal lining systems that are close fitting at ceiling, wall and floor junctions; or
 - (ii) sealed by caulking, skirting, architraves, cornices or the like.

ENERGY EFFICIENCY

Explanatory information:

1. A close fitting internal lining system is considered to include an allowance for minimum lining movement gaps at wall, floor and ceiling junctions.
2. Caulking includes sealant, expanded foam or other gap filling material.

3.12.3.6 Evaporative coolers

An evaporative cooler must be fitted with a self-closing damper or the like when serving—

- (a) a heated space; or
- (b) a *habitable room* in *climate zones* 4, 5, 6, 7 or 8.

PART 3.12.4 AIR MOVEMENT

3.12.4 Application

This Part applies to a *habitable room* in a Class 1 building.

Acceptable construction practice

3.12.4.1 Air movement

- (a) Air movement must be provided to *habitable rooms* in accordance with **Table 3.12.4.1**.
- (b) Air movement *required* by (a) may be provided through an opening from an adjoining room (including an enclosed verandah) if—
- the adjoining room is not a *sanitary compartment*; and
 - the opening between the adjoining room and the *habitable room* complies with **Table 3.12.4.1** as if it were a *ventilation opening* to the *habitable room* or a proportion thereof if some ventilation is provided from another source; and
 - the *ventilation opening* to the adjoining room complies with **Table 3.12.4.1** for the *floor area* of the adjoining room and the proportion of the *habitable room* that is ventilated from the adjoining room.
- (c) The requirements of (a) do not apply to buildings in Region D severe tropical cyclone areas (see **Figure 3.10.1.4**) provided the *external walls* are shaded with a verandah, balcony, eaves, carport or the like that projects at a minimum angle of 15 degrees in accordance with **Figure 3.12.1.2**.

Table 3.12.4.1 PROVISION FOR AIR MOVEMENT

Climate zones	Minimum total ventilation opening area as a percentage of the floor area for each habitable room		
	Without a ceiling fan or evaporative cooler	With a ceiling fan	With an evaporative cooler
1	10%	7.5%	10% (see Note)
2	10%	7.5%	10% (see Note)
3	10%	7.5%	7.5%
4	10%	5%	5%
5	7.5%	5%	7.5% (see Note)
6, 7, 8	As <i>required</i> by Part 3.8.5		

Note: Because evaporative coolers are less effective than ceiling fans in more humid locations, the requirement for *ventilation opening* in *climate zones* 1, 2 and 5 with an evaporative cooler is the same as without one.

ENERGY EFFICIENCY

Explanatory information:

In humid locations, such as Darwin and Cairns, evaporative coolers would not provide the same cooling effect as in dryer climates. Although they would provide some benefit from the air movement if operated in a “fan-only” mode, they would cause discomfort, possible condensation and possible mould growth if operated in an evaporative “water-on” mode. However, even though a concession is not given in *climate zones* 1, 2 and 5, there are locations, particularly in *climate zone* 5, where evaporative coolers would be effective.

3.12.4.2 Ventilation openings

- (a) In *climate zones* 1, 2, 3, 4 and 5, the total *ventilation opening* area *required* by **Table 3.12.4.1** to a *habitable room* must—
- (i) be connected by a breeze path complying with **(b)** to another *ventilation opening* in another room or space; or
 - (ii) be provided by a minimum of two *ventilation openings* located within the same *habitable room*, with each *ventilation opening* having an area of not less than 25% of the area *required* by **Table 3.12.4.1**.
- (b) A breeze path *required* by **(a)(i)** must—
- (i) pass through not more than two openings in the internal walls with each opening having an area of not less than 1.5 m²; and
 - (ii) have a distance along the breeze path between *ventilation openings* of not more than 20 m.

Explanatory information:

1. *Ventilation openings* should be designed to allow the interior of the building to take full advantage of any natural breeze. Careful consideration should be given to the type and location of openings to ensure optimum effect is achieved and that internal “dead air pockets” are avoided.
2. An opening may serve more than one breeze path.
3. Two openings are stated in **(b)(i)** as the limit of the number of openings permitted in a breeze path. These are typically doorways. Larger openings, such as those between adjoining lounge and dining areas in the same space are unlikely to restrict air movement significantly.

3.12.4.3 Ceiling fans and evaporative coolers

Ceiling fans or evaporative coolers *required* to comply with **3.12.0.1**, **Table 3.12.2.1** or **Table 3.12.4.1** must—

- (a) be permanently installed; and
- (b) have a speed controller; and
- (c) for ceiling fans, serve the whole room, with the *floor area* that a single fan serves not exceeding—
 - (i) 15 m² if it has a blade rotation diameter of not less than 900 mm; and
 - (ii) 25 m² if it has a blade rotation diameter of not less than 1200 mm.

PART 3.12.5 SERVICES

3.12.5 Application

This Part applies to—

- (a) a Class 1 building; and
- (b) a Class 10a building; and
- (c) a Class 10b *swimming pool* associated with a Class 1 or 10a building.

A. Acceptable construction manuals

3.12.5.0

A heated water supply system must be designed and installed in accordance with Part B2 of NCC Volume Three — Plumbing Code of Australia.

B. Acceptable construction practice

3.12.5.1 Insulation of services

Thermal insulation for central heating water *pipng* and heating and cooling ductwork must—

- (a) be protected against the effects of weather and sunlight; and
- (b) be able to withstand the temperatures within the *pipng* or ductwork; and
- (c) use thermal insulation material in accordance with AS/NZS 4859.1.

Explanatory information:

The central heating water *pipng* provisions apply to systems designed to heat the building via water, such as a hydronic heating system.

3.12.5.2 Central heating water piping

Central heating water *pipng* that is not within a *conditioned space* must be thermally insulated to achieve the minimum material *R-Value* in accordance with [Table 3.12.5.1](#).

ENERGY EFFICIENCY

Table 3.12.5.1 CENTRAL HEATING WATER PIPING—MINIMUM MATERIAL R-VALUE

<i>Piping</i> to be insulated	Minimum material <i>R-Value</i> for each <i>climate zone</i>		
	1, 2, 3 and 5	4, 6 and 7	8
1. Internal <i>piping</i>			
(a) All flow and return <i>piping</i> that is— (i) within an unventilated wall space; or (ii) within an internal floor between storeys; or (iii) between ceiling insulation and a ceiling. (b) All heated water <i>piping</i> encased within a concrete floor slab (except that which is part of a floor heating system).	0.4	0.4	0.4
2. <i>Piping</i> located within a ventilated wall space, an enclosed building sub-floor or a roof space			
(a) All flow and return <i>piping</i> . (b) Cold water supply <i>piping</i> — within 500 mm of the connection to the central water heating system. (c) Relief valve <i>piping</i> — within 500 mm of the connection to the central water heating system.	0.6	0.9	1.3
3. <i>Piping</i> located outside the building or in an unenclosed building sub-floor or roof space			
(a) All flow and return <i>piping</i> . (b) Cold water supply <i>piping</i> — within 500 mm of the connection to the central water heating system. (c) Relief valve <i>piping</i> — within 500 mm of the connection to the central water heating system.	0.6	1.3	1.3

Explanatory information:

- The insulation levels in the following table are typical examples of materials that can be used to insulate central heating water *piping* calculated in accordance with AS/NZS 4859.1.
- The *R-Value* is that of the insulation and not the *Total R-Value* of the pipe, air film and insulation. Where piping has a significant inherent *R-Value* it may be subtracted from the material *R-Value required*. However, the inherent *R-Value* of most piping material is not sufficient to satisfy the requirements in **Table 3.12.5.1**.
- Piping* within a timber member, such as that passing through a wall stud, is considered to have sufficient insulation for the purposes of **Table 3.12.5.1**.

ENERGY EFFICIENCY

4. The following table provides examples for the *R-Value* of the insulation used for smaller diameter piping.

Insulation	R-Value
9 mm of closed cell polymer	0.4
13 mm of closed cell polymer	0.6
19 mm of closed cell polymer	0.9
25 mm of closed cell polymer	1.3
25 mm of glasswool	1.3

3.12.5.3 Heating and cooling ductwork

- (a) Heating and cooling ductwork and fittings must—
- (i) achieve the material *R-Value* in [Table 3.12.5.2](#); and
 - (ii) be sealed against air loss—
 - (A) by closing all openings in the surface, joints and seams of ductwork with adhesives, mastics, sealants or gaskets in accordance with AS 4254 Parts 1 and 2 for a Class C seal; or
 - (B) for flexible ductwork, with a draw band in conjunction with a sealant or adhesive tape.
- (b) Duct insulation must—
- (i) abut adjoining duct insulation to form a continuous barrier; and
 - (ii) be installed so that it maintains its position and thickness, other than at flanges and supports; and
 - (iii) where located outside the building, under a suspended floor, in an attached Class 10a building or in a roof space—
 - (A) be protected by an outer sleeve of protective sheeting to prevent the insulation becoming damp; and
 - (B) have the outer protective sleeve sealed with adhesive tape not less than 48 mm wide creating an airtight and waterproof seal.
- (c) The requirements of (a) do not apply to heating and cooling ductwork and fittings located within the insulated building *envelope* including a service riser within the *conditioned space*, internal floors between storeys and the like.

Explanatory information:

Ductwork within a fully insulated building may still benefit from insulation particularly when the system is only operating for short periods.

In some *climate zones* condensation may create problems with uninsulated ductwork and insulation should still be considered.

ENERGY EFFICIENCY

Table 3.12.5.2 HEATING AND COOLING DUCTWORK AND FITTINGS—MINIMUM MATERIAL R-VALUE

Ductwork element	Minimum material <i>R-Value</i> for ductwork and fittings in each <i>climate zone</i>				
	Heating-only system or cooling-only system including an evaporative cooling system		Combined heating and refrigerated cooling system		
	1, 2, 3, 4, 5, 6 and 7	8	1, 3, 4, 6 and 7	2 and 5	8
Ductwork	1.0	1.5	1.5 (see note)	1.0	1.5
Fittings	0.4				

Note: The minimum material *R-Value required* for ductwork may be reduced by 0.5 for combined heating and refrigerated cooling systems in *climate zones* 1, 3, 4, 6, and 7 if the ducts are—

(a) under a suspended floor with an enclosed perimeter; or

(b) in a roof space that has insulation of not less than R0.5 directly beneath the roofing.

Explanatory information:

- For information on an enclosed perimeter, refer to the explanatory information following [Table 3.12.1.4](#).
- Insulation for refrigerated cooling ductwork should have a vapour barrier to prevent possible damage by condensation.
- The insulation levels in the following table are typical examples of materials that can be used to insulate ductwork and fittings and the *R-Values* they contribute. Other methods are available for meeting the minimum material *R-Value required* by [Table 3.12.5.2](#).

Insulation	<i>R-Value</i>
Fittings	
11 mm polyurethane	0.4
Flexible ductwork	
45 mm glasswool (11 kg/m ³)	1.0
70 mm polyester (6.4 kg/m ³)	1.0
63 mm glasswool (11 kg/m ³)	1.5
90 mm polyester (8.9 kg/m ³)	1.5
85 mm glasswool (11 kg/m ³)	2.0
Sheetmetal ductwork — external insulation	
38 mm glasswool (22 kg/m ³)	1.0

ENERGY EFFICIENCY

Insulation	R-Value
50 mm polyester (20 kg/m ³)	1.1
50 mm glasswool (22 kg/m ³)	1.5
75 mm polyester (20 kg/m ³)	1.7
Sheetmetal ductwork — internal insulation	
38 mm glasswool (32 kg/m ³)	1.0
50 mm polyester (32 kg/m ³)	1.3
50 mm glasswool (32 kg/m ³)	1.5

4. Any flexible ductwork used for the transfer of products, initiating from a heat source that contains a flame, must also have the fire hazard properties *required* by 3.7.1.9.

3.12.5.4 Electric resistance space heating

An electric resistance space heating system that serves more than one room must have—

- separate isolating switches for each room; and
- a separate temperature controller and time switch for each group of rooms with common heating needs; and
- power loads of not more than 110 W/m² for living areas, and 150 W/m² for bathrooms.

3.12.5.5 Artificial lighting

- The *lamp power density* or *illumination power density* of artificial lighting, excluding heaters that emit light, must not exceed the allowance of—
 - 5 W/m² in a Class 1 building; and
 - 4 W/m² on a verandah, balcony or the like attached to a Class 1 building; and
 - 3 W/m² in a Class 10a building associated with a Class 1 building.
- The *illumination power density* allowance in (a) may be increased by dividing it by the *illumination power density* adjustment factor for a control device in Table 3.12.5.3 as applicable.
- When designing the *lamp power density* or *illumination power density*, the power of the proposed installation must be used rather than nominal allowances for exposed batten holders or luminaires.

Explanatory information:

- There are two approaches available for achieving compliance with (a) in Class 1 and associated Class 10a buildings. These are through the determination of the *lamp power density* or the *illumination power density*.
- The first step in achieving compliance is to determine the relevant *lamp power density* or *illumination power density* allowance. Generally the *lamp power density* or *illumination power density* is the relevant value in (a)(i), (ii) or (iii), however the *illumination power density* allowance can be increased in accordance with (b) if a control device is used.

ENERGY EFFICIENCY

When *illumination power density* and one or more control devices are used, the adjustment factor is only applied to the space(s) served by the control device. The adjusted allowance for this space is then combined with the allowances for the remaining spaces using an area weighted average, which subsequently increases the allowance provided in (a)(i), (ii) or (iii).

When no control device is used, the adjustment factor is equal to 1.

The second step in achieving compliance is to assess the design *lamp power density* or design *illumination power density*.

3. The design *lamp power density* is calculated by adding the maximum power ratings of all the permanently wired lamps in a space and dividing this sum by the area of the space.
4. The design *illumination power density* is calculated by adding the illumination power load for each space and dividing this sum by the area of the space.

Control device adjustment factors in (b) are only applied to the *illumination power density*, not the design *illumination power density*.

5. To comply with (a), the design *lamp power density* or design *illumination power density* must be less than or equal to the allowance.
6. Trading of allowances between (a)(i), (ii) and (iii) is not permitted.
7. (a)(ii) includes outdoor living spaces such as verandahs, balconies, patios, alfresco spaces or the like that are attached to a Class 1 building.

- (d) Halogen lamps must be separately switched from fluorescent lamps.
- (e) Artificial lighting around the perimeter of a building must—
 - (i) be controlled by a daylight sensor; or
 - (ii) have an average light source efficacy of not less than 40 Lumens/W.

Explanatory information:

The artificial lighting around the perimeter of a building does not need to comply to a maximum power density as neither the lighting required or the area of the space can be easily defined. Instead, external lights are required to be controlled by daylight sensors or to be efficient.

Table 3.12.5.3 ILLUMINATION POWER DENSITY ADJUSTMENT FACTOR FOR A CONTROL DEVICE

Item	Description	<i>illumination power density</i> adjustment factor
Lighting timer	For corridor lighting	0.7

ENERGY EFFICIENCY

Table 3.12.5.3 ILLUMINATION POWER DENSITY ADJUSTMENT FACTOR FOR A CONTROL DEVICE — continued

Item	Description	Illumination power density adjustment factor
Motion detector	(a) Where— (i) at least 75% of the area of a space is controlled by one or more motion detectors; or (ii) an area of less than 200 m ² is switched as a block by one or more detectors.	0.9
	(b) Where up to 6 lights are switched as a block by one or more detectors.	0.7
	(c) Where up to 2 lights are switched as a block by one or more detectors.	0.55
Manual dimming system Note 1	Where not less than 75% of the area of a space is controlled by manually operated dimmers.	0.85
Programmable dimming system Note 2	Where not less than 75% of the area of a space is controlled by programmable dimmers.	0.85
Dynamic dimming system Note 3	Automatic compensation for lumen depreciation.	The design lumen depreciation factor of not less than— (a) for fluorescent lights, 0.9; or (b) for high pressure discharge lights, 0.8.
Fixed dimming Note 4	Where at least 75% of the area is controlled by fixed dimmers that reduce the overall lighting level and the power consumption of the lighting.	% of full power to which the dimmer is set divided by 0.95.
Daylight sensor and dynamic lighting control device – dimmed or stepped switching of lights adjacent <i>windows</i>	(a) Lights within the space adjacent to <i>windows</i> other than <i>roof lights</i> for a distance from the <i>window</i> equal to the depth of the floor to <i>window</i> head height.	0.5 ^{Note 5}
	(b) Lights within the space adjacent to <i>roof lights</i> .	0.6 ^{Note 5}

ENERGY EFFICIENCY

Table 3.12.5.3 ILLUMINATION POWER DENSITY ADJUSTMENT FACTOR FOR A CONTROL DEVICE — continued

Item	Description	<i>Illumination power density adjustment factor</i>
<p>Notes:</p> <ol style="list-style-type: none"> 1. Manual dimming is where lights are controlled by a knob, slider or other mechanism or where there are pre-selected scenes that are manually selected. 2. Programmed dimming is where pre-selected scenes or levels are automatically selected by the time of day, photoelectric cell or occupancy sensor. 3. Dynamic dimming is where the lighting level is varied automatically by a photoelectric cell to either proportionally compensate for the availability of daylight or the lumen depreciation of the lamps. 4. Fixed dimming is where lights are controlled to a level and that level cannot be adjusted by the user. 5. The <i>illumination power density</i> adjustment factor is only applied to lights controlled by that item. This adjustment factor does not apply to tungsten halogen or other incandescent sources. 		

3.12.5.6 Water heater in a heated water supply system

A water heater in a heated water supply system must be designed and installed in accordance with Part B2 of NCC Volume Three — Plumbing Code of Australia.

3.12.5.7 Swimming pool heating and pumping

- (a) Heating for a *swimming pool* must be by—
- (i) a solar heater not boosted by electric resistance heating; or
 - (ii) a heater using reclaimed energy; or
 - (iii) a gas heater; or
 - (iv) a heat pump; or
 - (v) a combination of (i) to (iv).
- (b) Where some or all of the heating *required* by (a) is by a gas heater or a heat pump, the *swimming pool* must have—
- (i) a cover unless located in a *conditioned space*; and
 - (ii) a time switch to control the operation of the heater.
- (c) A time switch must be provided to control the operation of a circulation pump for a *swimming pool*.
- (d) For the purposes of 3.12.5.7, a *swimming pool* does not include a spa pool.

Explanatory information:

Some jurisdictions may have requirements for a pool cover under the Smart Approved Water Mark Scheme.

ENERGY EFFICIENCY

3.12.5.8 Spa pool heating and pumping

- (a) Heating for a spa pool that shares a water recirculation system with a *swimming pool* must be by—
- (i) a solar heater; or
 - (ii) a heater using reclaimed energy; or
 - (iii) a gas heater; or
 - (iv) a heat pump; or
 - (v) a combination of **(i)** to **(iv)**.
- (b) Where some or all of the heating *required* by **(a)** is by a gas heater or a heat pump, the spa pool must have—
- (i) a cover; and
 - (ii) a push button and a time switch to control the operation of the heater.
- (c) A time switch must be provided to control the operation of a circulation pump for a spa pool having a capacity of 680 L or more.

ADDITIONS

Commonwealth of Australia

Australian Capital Territory

New South Wales

Northern Territory

Queensland

South Australia

Tasmania

Victoria

Western Australia

ADDITIONS

APPENDIX A CONTENTS

APPENDIX A ADDITIONS

CONTENTS

COMMONWEALTH OF AUSTRALIA

Footnote: Other Legislation and Policies Affecting Buildings

Footnote: OTHER LEGISLATION AND POLICIES AFFECTING BUILDINGS

In addition to any applicable provisions of this Code, there are a number of other legislative technical requirements and policies affecting the design, construction and/or performance of buildings that practitioners may need to be aware of, including, but not necessarily limited to, the following list. Additional legislative instruments such as regulations, codes and standards may exist under the legislation listed.

1. Australian Capital Territory

1.1 Administering Agency

Department of Finance

Relevant Legislation

Australian Capital Territory (Planning and Land Management) Act 1988

Parliament Act 1974

2. Defence Buildings

2.1 Administering Agency

Department of Defence

Relevant Legislation

Defence Act 1903

Relevant Regulations

Defence (Areas Control) Regulations 1989

Relevant Codes, Standards and Publications

Manual of Fire Protection Engineering

Requirements for the Provision of Disabled Access and other Facilities for People with a Disability in Defence

Heating , Ventilation and Air Conditioning Policy

Microbial Control in Air Handling and Water Systems of Defence Buildings

Building Energy Performance Manual

Manual of Infrastructure Engineering - Electrical

Manual of Infrastructure Engineering - Bulk Fuel Installation Design

Defence Communications Cabling Standard

Defence Training Area Management Manual

Defence Safety Manual

Defence Security Manual

Defence Explosive Ordinance Publications

The Defence Estate Quality Management System (<http://www.defence.gov.au/im/>) contains further requirements including the principles of development, zone planning, site

ADDITIONS

selection, engineering requirements and environmental impact assessment and approval requirements.

3. Disability Discrimination

3.1 Administering Agency

Attorney-General's Department

Relevant Legislation

Disability Discrimination Act 1992

Disability (Access to Premises - Buildings) Standards 2010

Disability Standards for Accessible Public Transport 2002

4. Environment

4.1 Administering Agency

Department of the Environment

Relevant Legislation

Environmental Protection and Biodiversity Conservation Act 1999

Environmental Protection and Biodiversity Conservation Regulations 2000

4.2 Administering Agency

Department of Industry

Relevant Policy

Energy Efficiency in Government Operations (2006)

5. Jervis Bay Territory

5.1 Administering Agency

Department of Infrastructure and Regional Development

Relevant Legislation

Jervis Bay Territory Acceptance Act 1915

6. Occupational Health and Safety

6.1 Administering Agency

Department of Employment

Relevant Legislation

Work Health and Safety Act 2011

Work Health and Safety Regulations 2011

7. Territory of Christmas Island

7.1 Administering Agency

Department of Infrastructure and Regional Development

ADDITIONS

Relevant Legislation

Christmas Island Act 1958

CONTENTS

AUSTRALIAN CAPITAL TERRITORY

ACT 1 * * * * *

Health and amenity

ACT 2 Control of Litter on Building Sites

ACT 3 Waste Management

ACT 6 Swimming pool construction

ACT 7 Sustainability

Footnote: Other Legislation Affecting Buildings

ADDITIONS

AUSTRALIAN CAPITAL TERRITORY ADDITIONS

Application of Australian Capital Territory additions

This Appendix contains additional provisions for application in the Australian Capital Territory as follows:

ACT 1 * * * * *

This clause has been deliberately left blank.

HEALTH AND AMENITY

ACT 2 — CONTROL OF LITTER ON BUILDING SITES

ACT 2.1 PERFORMANCE PROVISIONS

Objective

The *Objective* of this provision is to prevent windblown litter from building sites fouling roads and public land.

Functional Statement

Building litter must be prevented from spreading around the site and beyond the site boundary.

Performance Requirement

Sufficient containers must be provided on building sites to store building waste that is likely to become windblown.

ACT 2.2 ACCEPTABLE CONSTRUCTION PRACTICE

The requirements of **ACT 2.1** (*Performance Requirement*) are satisfied by:

On site building waste that is stored in suitable size plastic or metal bins and removed from the site at regular intervals.

Note:

Building Waste includes: plastic containers and plastic and paper wrappings or any waste that can be carried by wind.

ACT 3 — WASTE MANAGEMENT

ACT 3.1 PERFORMANCE PROVISIONS

Objective

The *Objective* of this provision is to safeguard people from injury caused by infection or contamination from solid waste.

Functional Statement

Buildings must be provided with space and facilities for the collection, and safe hygienic holding prior to disposal of solid waste arising from the intended use of the building.

Performance Requirement

Where provision is made within buildings for the collection and temporary holding of solid waste, the design shall accommodate screening, volume of waste, disposal, logistics and access.

ACT 3.2 ACCEPTABLE CONSTRUCTION PRACTICE

The requirements of **ACT 3.1** (*Performance Requirement*) are satisfied by garbage facilities that are designed and constructed in accordance with the Development Control Code for Best Practice Waste Management in the ACT.

ACT 6 — SWIMMING POOL CONSTRUCTION

Application:

This requirement is to be applied in conjunction with **Part 3.9.3**.

ACT 6.1 SWIMMING POOL CONSTRUCTION

Indoor or outdoor permanent bathing, wading and *swimming pools* must—

- (a) where the capacity of the pool exceeds 10 m³—
 - (i) be of the recirculation type in which the water circulation is maintained through the pool by pumps, the water drawn from the pool being clarified and disinfected before being returned to the pool; and
 - (ii) have means of egress provided in the form of ladders, steps in the floor of the pool or a ramp; and
- (b) be capable of being completely emptied and any discharge or overflow and pool backwash filter must be connected to the sewer drainage system.

ACT 7 — SUSTAINABILITY

Note:

ACT legislation other than the BCA also regulates for sustainability when constructing or altering buildings, including their services. For example, the Water and Sewerage Act 2000 has relevant provisions about water heaters, water and sanitary plumbing, and sanitary drainage, which are intended to facilitate a reduction in water usage and energy used to heat water, and greenhouse gas emission. If there is an inconsistency between requirements for the same aspect of water heaters in the BCA and the Water and Sewerage Act 2000, the latter prevails to the extent of the inconsistency.

The Building (General) Regulation 2004 has provisions about applying certain BCA provisions and alternatives to those provisions, to pre-existing parts of certain buildings, aimed at increasing the energy efficiency of the existing part, amongst other things, when the existing building is substantially altered or extended.

Practitioners should ensure they check the latest version of relevant legislation, and the latest version of this appendix, available through the ACT legislation register at www.legislation.act.gov.au.

ACT 7.1 ENERGY EFFICIENCY OF BUILDING ALTERATIONS

Application:

ACT Part 7.1 applies to work in relation to adding to or extending a completed building that can be lawfully occupied or used, where there is not otherwise a requirement to bring into BCA compliance the unaltered part of the building.

Certain substantial alterations or extensions to completed buildings can trigger a requirement under ACT law to bring the unaltered part of the building into BCA compliance. **ACT Part 7.1** does not relate to any mandatory requirements to change the otherwise unaltered part of a building, but **ACT Part 7.1** can apply to the addition or extension and to unaltered parts where permitted by this part.

The BCA's provisions generally are intended to apply to construction of entire new buildings and are not inherently intended to apply to altering or extending completed buildings. Nevertheless, ACT legislation requires certain alterations and additions to existing buildings to be done only in a way that produces a building, or affected part, that complies with the BCA.

For the purposes of applying **ACT Part 7.1**, it is taken as providing additional BCA requirements that only apply in the case of relevant additions and alterations.

ACT 7.1.2(d) and **ACT 7.1.2(c)** prevent alterations and additions reducing the existing energy efficiency of certain buildings. Nothing in **ACT 7.1.2(d)** or **ACT 7.1.2(c)** necessarily requires an energy efficiency rating to demonstrate compliance. Compliance could be demonstrated, for example, through checking that the alteration or addition does not adversely impact on aspects of the existing building that contribute to assessment of its energy efficiency.

ADDITIONS

Note:

The ABCB publishes non-mandatory, non-regulatory information handbooks, about BCA energy efficiency provisions, which clarify that State and Territory legislation applies, or varies the application of, BCA provisions to existing buildings or to alterations or additions to buildings. Some State and Territory legislation permits hypothetical simulation of upgrading elements of existing buildings to facilitate the energy efficiency of new elements in a building extension, without requiring construction to match the simulation. For example, to suppose that glazing units in a dwelling will be upgraded to comparable performance levels of new glazing units in an extension to the dwelling, in order to reduce the burden on the new glazing that arises from having to compensate for the poorer performance of the old glazing. That is not the case in the ACT, and the older glazing's actual performance must be assessed where applicable, unless a relevant law provides otherwise.

Explanatory information:

ACT Part 7.1 is intended to help make designs for house extensions comply with the intent of **P2.6.1** and **P2.6.2**. It provides a range of extra options to achieve, compliance, in addition to the BCA's options. Some of the options cannot be used in combination with others, but others can be used in combination, as explained in the respective clauses. The options are summarised below, and provide for:

- Allowing the extension to the house to be assessed using house energy rating software, rather than that software only being applicable to the whole of a house (see **ACT 7.1.2**).
- Allowing the house extension to meet the elemental provisions (insulation levels, window performance, sealing, etc) of the BCA's energy efficiency provisions, rather than the BCA's house energy rating requirements (see **ACT 7.1.3**).
- Allowing the effect of certain window treatments such as blinds, curtains, shutters or pelmets to be considered when assessing the thermal performance of existing windows (see **ACT 7.1.4(a)**).
- Excluding assessment of thermal performance of an existing window if it is treated with a solar control film (see **ACT 7.1.4(d)** and the dispensation under the ACT's Building (General) Regulation 2008, section 29 (1), which allows windows to not comply with the BCA if they have the prescribed film applied).
- Excluding assessment of thermal performance of an existing window if it is thermally isolated from windows that must be assessed (see **ACT 7.1.4(d)** in addition to the dispensation under the ACT's Building (General) Regulation 2008, section 29 (2), which allows windows to not comply with the BCA if they are separated from windows that have to be assessed, by prescribed separating walls, floors, ceilings and doors).
- Allowing the use of the ABCB 2009 glazing calculator or later to determine window thermal performance compliance where northerly glazing is impractical to provide in a house extension (see **ACT 7.1.4(c)**).
- Concessions on use of existing building services, such as reuse of and sealing of ducted air conditioning and reuse of hot water services (see **ACT 7.1.6**).

This is explained in the following flow chart.

ADDITIONS

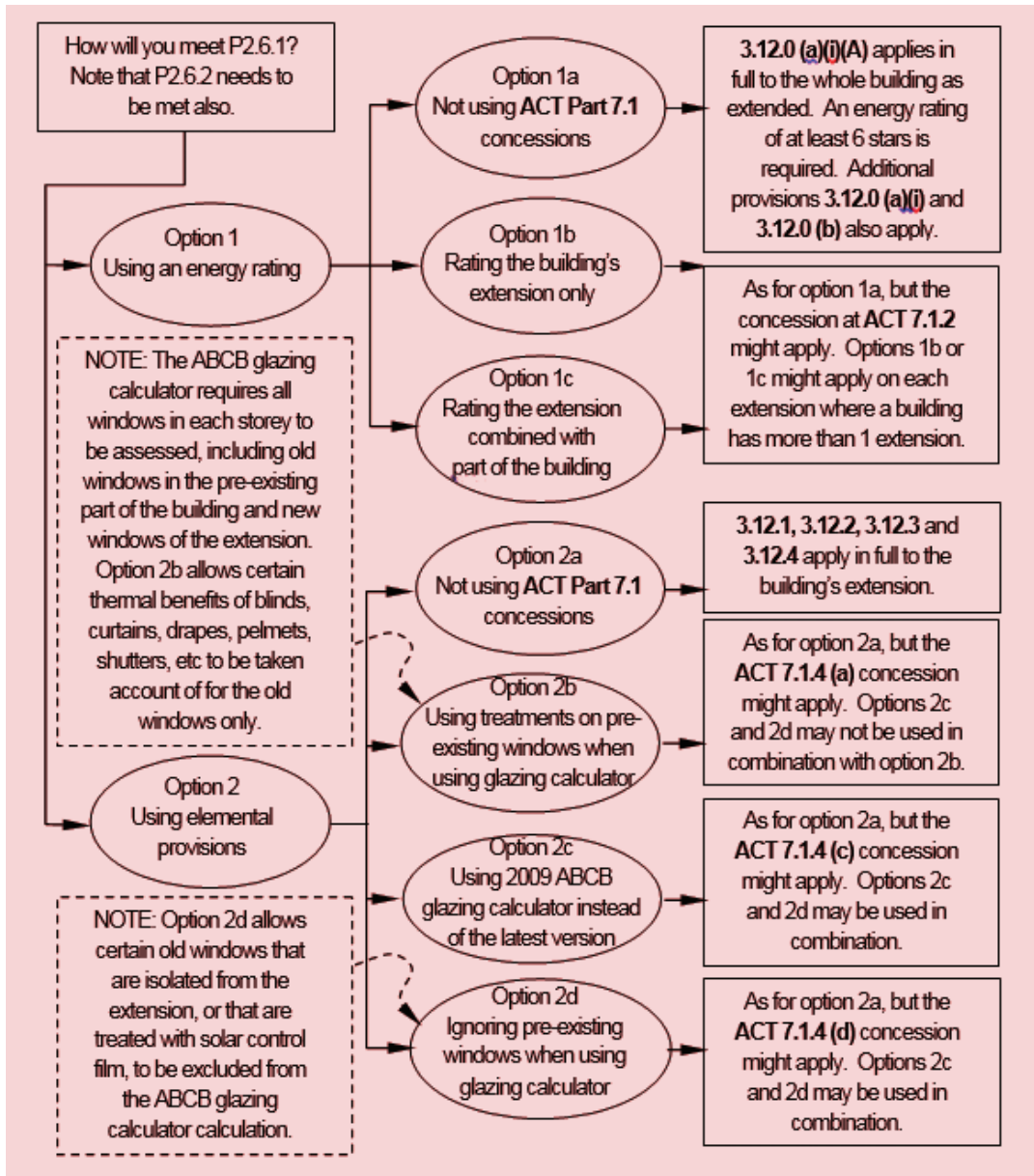

ACT 7.1.1 Application of Part 3.12 and ACT 7

Alterations, additions and extensions to existing completed buildings that would be subject to **Part 3.12** if built now, must comply with **Part 3.12** except to the extent that **ACT 7** permits otherwise. **ACT 7** provides concessions on certain aspects of **Part 3.12**. The BCA does not directly require unaltered parts of the existing building to be brought into BCA compliance, but certain other requirements do. For example—

- the ACT Building Act 2004 requires certain buildings that have more than 50% of their floor area altered in a 3-year period to be brought into BCA compliance, subject to concessions in the *ACT Building (General) Regulation 2008*; and

ADDITIONS

- use of the ABCB's glazing calculator requires all relevant glazing in each storey of a building to be assessed. In the case of an extension to an existing building with existing windows, any new windows in the extension as well as old windows in the existing part of the building need to be assessed together if they are on the same storey, subject to concessions in **ACT 7**; and
- certain discretionary concessions in **ACT 7** require certain energy efficiency measures to be in place in the existing part of the building to be extended, such as thermal insulation to the existing roof, or window blinds, curtains, drapes, pelmets or shutters to existing windows.

ACT 7.1.2 Heating & cooling loads

- (a) Subject to **(b)** to **(e)**, **3.12.0(a)(i)** may apply to—
- (i) a whole dwelling as added to or as extended; or
 - (ii) a house-like addition or extension as if **3.12.0.1** expressly indicated it applied to a large part of a building and as if the rating scheme and protocol mentioned in **3.12.0.1** applied to rating large additions or extensions to buildings rather than rating a whole building.
- (b) For **(a)(ii)**, an addition or extension is not house-like unless—
- (i) it has a contiguous floor area of at least 100 m² including any contiguous existing floor area up to no more than 50 m² of the unaltered part of the building, that needs to be incorporated into the rating to minimise inaccuracy due to the effect of nearby elements of the unaltered parts; and
 - (ii) it has at least 1 kitchen within the floor area mentioned in **(i)**; and
 - (iii) the floor area mentioned in **(i)** is isolated from other buildings and from the remainder of the unaltered part of the building by a draft-proof barrier such as walls, floor, ceiling and a draft-sealed door, all of which comply with **3.12.3**.
- (c) If **(a)(ii)** is applied, the following must be included as part of determining the rating mentioned in **(a)(ii)**—
- (i) the relevant properties of any existing and unaltered roof, internal wall, or external wall that is taken as being part of the thermal envelope of the contiguous floor area of the addition or extension; and
 - (ii) the remainder of the unaltered part of the building must be taken as a separate building adjoining the addition or extension, if it adjoins the part of the building being rated.
- (d) **ACT 7.1.2** does not apply if compliance with it would result in a building (or part thereof), as extended or altered, having its energy efficiency reduced below—
- (i) the relevant statutory minimum, which is the minimum energy efficiency requirement, if any, that all or part of the building, respectively, was required to achieve when constructed or altered; or
 - (ii) for a building that has not been altered or extended, the current energy efficiency of the building, which is the lesser of its energy efficiency determined using the factors **Part 3.12** covers, or the energy efficiency it would be required to achieve under **Part 3.12** if it was to be built; or
 - (iii) for the following parts of a building—an unaltered, unextended, altered, or extended part—the energy efficiency for the part as per **(ii)** as if **(ii)** applied to the part.

ADDITIONS

Example for ACT 7.1.2(d):

A house constructed in 1980 was not required to be energy efficient. However, recently R4.0 bulk thermal insulation batts were installed in the roof space. **Part 3.12** covers thermal insulation performance of roofs. **ACT 7.1.2** does not apply to removing the bulk thermal insulation for use in an extension to the house. The house was extended in 2008 (the first extension). The first extension was required to comply with BCA 2008. A proposed second extension will shade northerly glazing in the first extension, bringing the first extension out of compliance with BCA 2008. Therefore, **ACT 7.1.2** does not apply to shading the window without offsetting the detrimental effect that shading would have to the first extension's energy efficiency even though the first extension does not comply with the requirements of current **Part 3.12**.

- (e) Dispensations in an ACT building legislation, however described, that may allow existing elements to not comply with the BCA under a *deemed-to-satisfy* method must not be applied to an energy efficiency rating under **3.12.0.1** or **ACT 7.1.2**. All relevant existing elements must be assessed in respect of their actual performance without dispensation.

Explanatory information:

An alternative option to the EER provisions option is to make the relevant building elements comply with the respective energy efficiency provisions. That alternative option is referred to as the 'elemental provisions'. Elemental provisions are set out at **3.12.0(a)(ii)** and **ACT 7.1.3** to **ACT 7.1.5**.

Explanatory information:

The energy rating scheme and protocol mentioned in **3.12.0.1** are intended to only apply to whole houses, not to only an addition or extension to a house, nor to part of a house that is less than the entire thermal envelope of the house. However, they can apply to attached houses to assess one or other attached house separately. Thus, they can produce reasonably reliable information about an extension to a house if the extension is comparable to adding an additional house to the existing house to form 2 attached houses.

If only an addition or extension to a house is rated, the rating is not necessarily a reflection of the house's overall rating. Although area correction factors are included in relevant energy rating software, the accuracy of ratings can decrease with reduced size and number of rooms rated. Therefore, **ACT 7.1.2** limits use of a rating to large additions or extensions.

As the energy rating scheme mentioned in **3.12.0.1** is intended to apply to a whole building, an assessment in regulatory mode must include a kitchen zone. In order to avoid the pretence of applying false heating and cooling loads to a zone, **ACT 7.1.2** is limited to house additions or extensions containing a kitchen in the rated area. This can include an existing or new kitchen area.

ACT 7.1.2 permits small parts of an existing house to be incorporated into the addition or extension, to take account of draft-proof barriers that are not located at the interface between the existing house and the addition or extension. The construction details of any existing part incorporated into an addition or extension for rating purposes must not be assessed as having the same relevant details as the remainder of the addition or extension unless they are actually the same in both. For example, if the existing part is bounded by an internal wall with no bulk thermal insulation added, that wall must not be assessed as having the same properties as the remainder of the insulated bounding walls, unless they actually have the same relevant properties, (see **Figure ACT 7.1.1**).

ADDITIONS

Figure ACT 7.1.1

Diagram a. Addition not incorporating floor area from existing dwelling

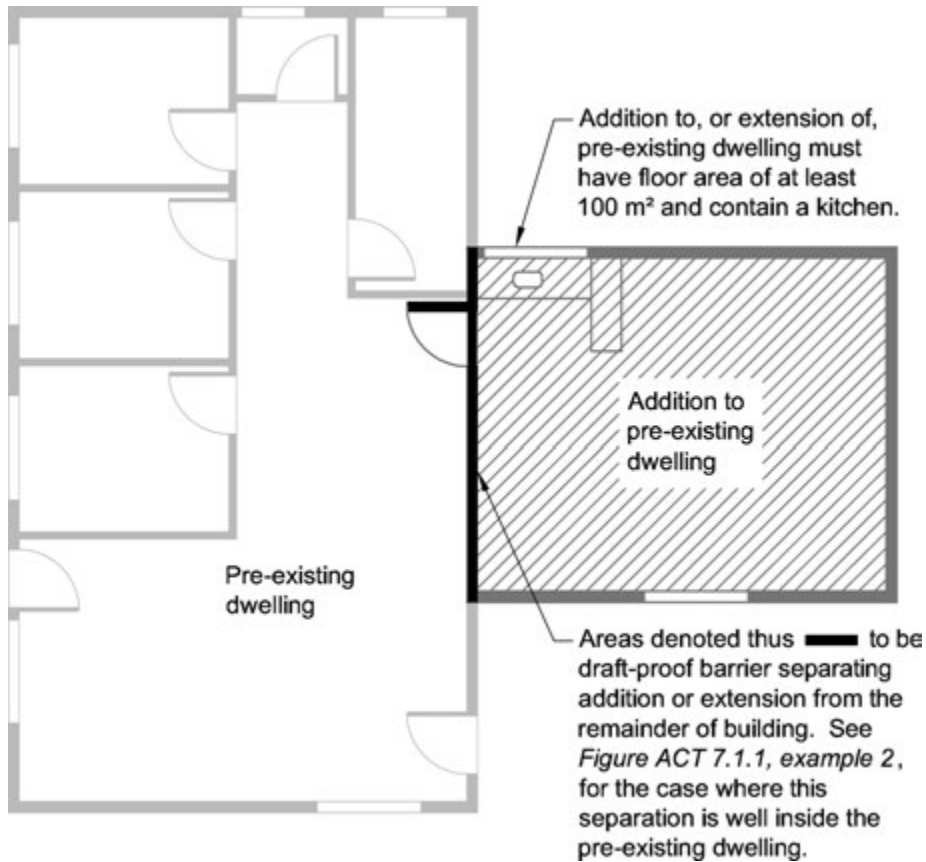

Note: Plan showing compliance with certain requirements of [ACT 7.1.2\(a\)\(ii\)](#) and [\(b\)](#), without incorporating floor area of an existing dwelling into the relevant floor area of an addition or extension to the dwelling. This is relevant where house energy efficiency rating software is used to demonstrate compliance.

ADDITIONS

Figure ACT 7.1.1

Diagram b. Addition incorporating floor area from existing dwelling

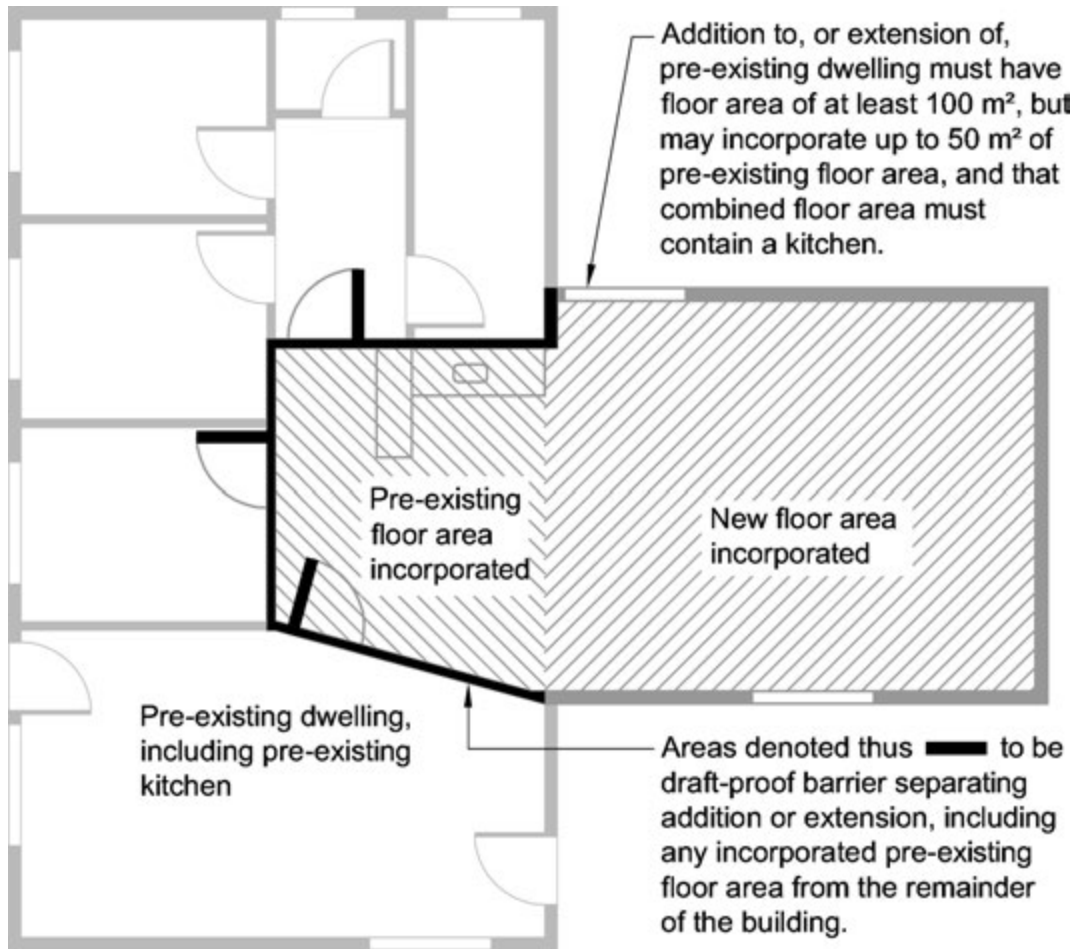

Note: Plan showing compliance with certain requirements of [ACT 7.1.2\(a\)\(ii\)](#) and [\(b\)](#), incorporating a small amount of floor area of an existing dwelling into the relevant floor area of an addition or extension to the dwelling. This is relevant where house energy efficiency rating software is used to demonstrate compliance.

ACT 7.1.3 Building fabric—application of Part 3.12.1

Where [Part 3.12.1](#) requires building elements such as walls to have thermal insulation that forms a continuous thermal barrier, but an addition or extension opens directly, or by a common door, onto the unaltered part of building, the thermal barrier need not extend into the unaltered part of the building, except where contrary intention appears in [Part 3.12.1](#).

ACT 7.1.4 External glazing—application of Part 3.12.2

ADDITIONS

- (a) Subject to (b), in applying **Part 3.12.2** to an addition or extension all glazing on the respective storey, including the addition or extension and any existing glazing in the unaltered part of the storey, must be assessed where **Part 3.12.2** indicates the whole storey must be assessed. However, the *Total System U-Value* of an existing glazing unit in the unaltered part of the building can take account of any of the following:
- (i) Window treatments listed in **Table ACT 7.1.4.1**, to the extent provided in that table, where the glazing unit incorporates the respective treatment in compliance with the notes to that table.
 - (ii) Window shutters mentioned in Annex G of international standard ISO 10077-1, (Thermal performance of windows, doors and shutters — Calculation of thermal transmittance), where the glazing unit is readily closed in by the shutters, and the shutters can be readily opened so they do not shade the glazing of the unit, and the closed shutters comply with the respective construction, material and permeability provisions of that Annex G.

Note:

The *Total System U-Value* of the existing glazing unit, incorporating shutters, can be calculated by adding the inverse of the respective shutters' value of additional thermal resistance, ΔR , from Table G.1 (Additional thermal resistance for windows with closed shutters), of the above-mentioned Annex G.

- (b) **ACT 7.1.4(a)** does not apply to windows otherwise dealt with under (c) or (d).
- (c) If an addition or alteration fails to incorporate a wall that can contain translucent glazing with an area of at least 1 m² or 1% of the addition's or alteration's *floor area*, whichever is the greater, not overshadowed by a building in winter, and orientated within the north sector shown in **Figure 3.12.2.1**, then all glazing (existing or otherwise) in the storey need not comply with the requirements of **3.12.2.1** that relate to aggregate conductance of the glazing if—
- (i) the addition or alteration has a total floor area not exceeding 50 m²; and
 - (ii) compliance with the requirements of **3.12.2.1** that relate to aggregate conductance of the glazing would not result in a building (or part thereof), as extended or altered, having its energy efficiency reduced below—
 - (A) the relevant statutory minimum, which is the minimum energy efficiency requirement, if any, that all or part of the building, respectively, was required to achieve when constructed or altered; or
 - (B) for a building that has not been altered or extended, the current energy efficiency of the building, which is the lesser of its energy efficiency determined using the factors **Part 3.12** covers, or the energy efficiency it would be required to achieve under **Part 3.12** if it was to be built; or
 - (C) for the following parts of a building—an unaltered, unextended, altered, or extended part—the energy efficiency for the part as per (ii) as if (ii) applied to the part—
 - (aa) the aggregate conductance of the glazing is in accordance with BCA requirements that applied in the ACT immediately before or anytime after the adoption of BCA 2010 in the ACT; and
 - (bb) bulk thermal insulation has been added to the roof of the unaltered part of the building, in accordance with the requirements of **3.12.1.2**

ADDITIONS

that apply to roofs with an upper surface solar absorptance value of not more than 0.4.

- (d) The Building (General) Regulation 2008, section 29 (Unaltered parts need not comply with building code—alternative energy efficiency requirements for external glazing Act, s 29 (2) (b)) prescribes when windows with solar control film or when ‘isolated glazing’ need not comply with the BCA, **Part 3.12.2**, in relation to a substantial alteration mentioned in the Building Act 2004, section 29 (Approval requirements). Those alternative energy efficiency provisions may apply to existing windows that **ACT 7** applies to whether or not the window is in respect of a ‘substantial alteration’ as defined in the Building (General) Regulation 2008, section 23 (Substantial alteration—Act 29 (2) (a)).

ADDITIONS

Figure ACT 7.1.4

Diagram a. Addition incorporating a wall within the north sector

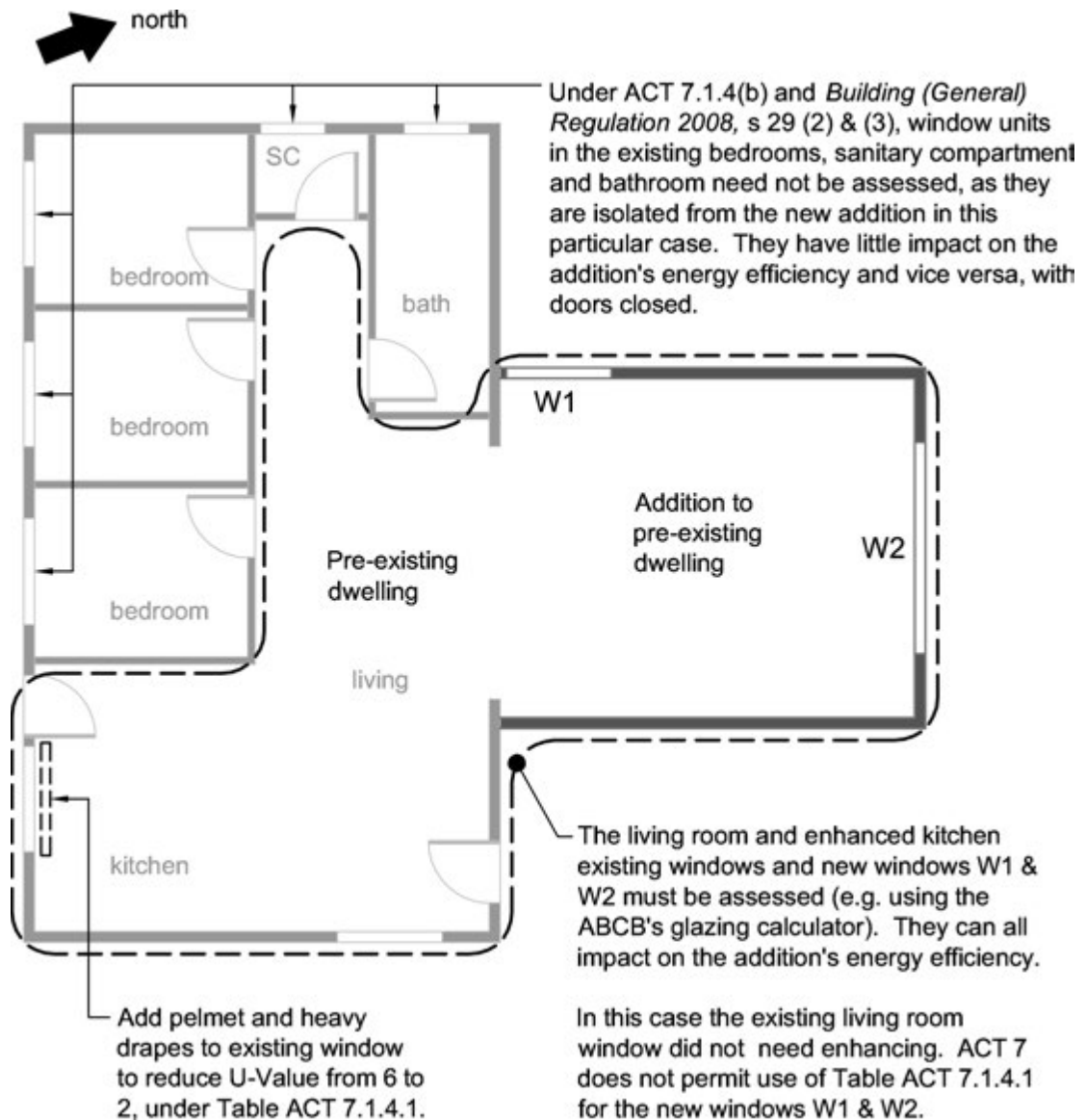

Note: Plan showing a method of compliance with certain requirements of [ACT 7.1.4\(a\)](#) and [\(b\)](#), in assessing window energy efficiency as part of a deemed-to-satisfy alternative to using house energy efficiency rating software.

ADDITIONS

Figure ACT 7.1.4

Diagram b. Addition not incorporating a wall within the north sector

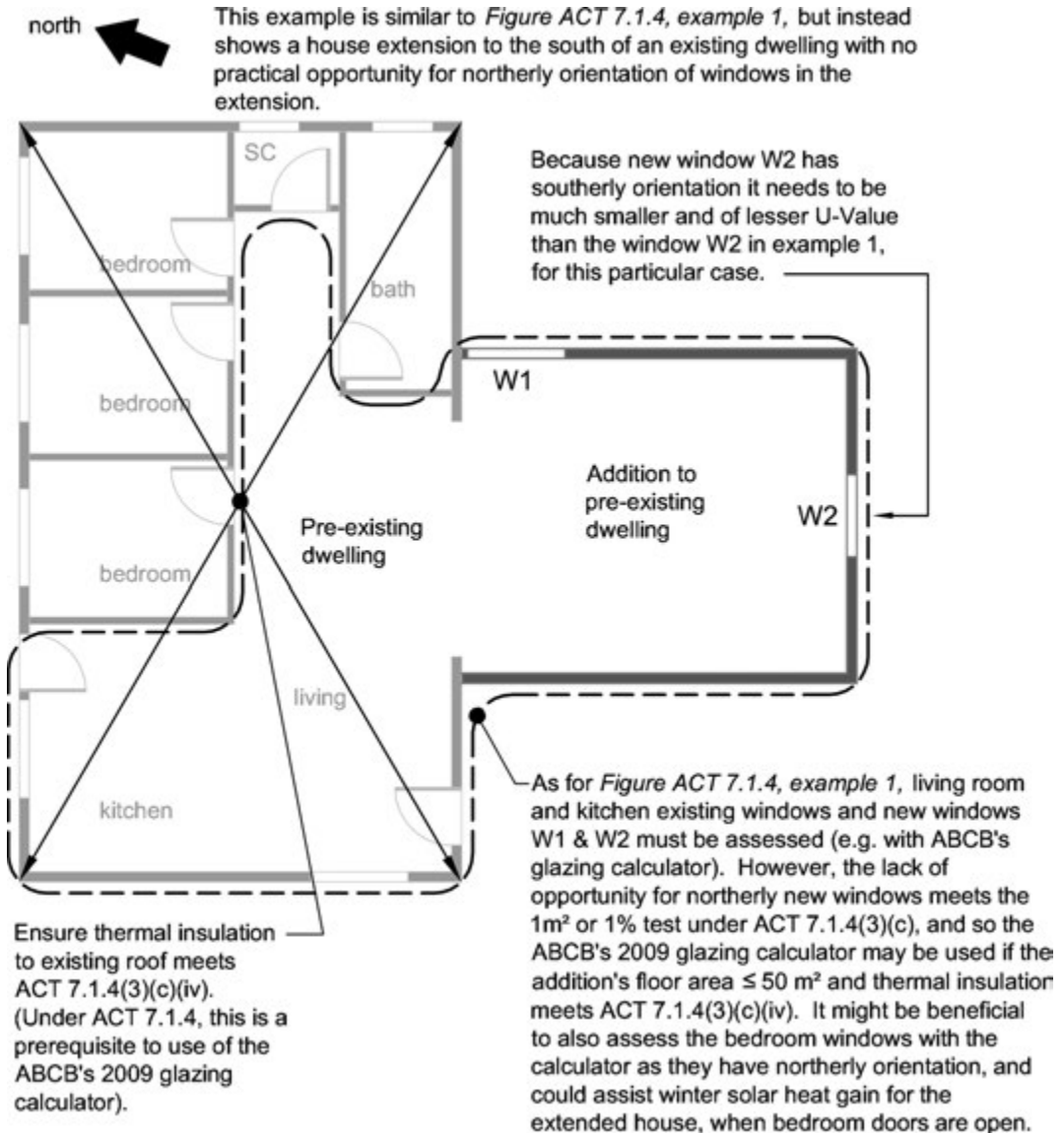

Note: Plan showing a method of compliance with certain requirements of [ACT 7.1.4\(c\)](#), in assessing window energy efficiency as part of a deemed-to-satisfy alternative to using house energy efficiency rating software, where the ABCB's 2009 glazing calculator may be used rather than the current calculator, as a concession.

ADDITIONS

Table ACT 7.1.4.1 Glazing unit U-Values

Glazing unit (not taking account of any window treatments)		Improved U-Values with window treatments				
		A	B	C	D	E
U-Value	R-Value	Holland blinds only	Closed weave curtains only	Heavy drapes only	Closed weave curtains & pelmet	Heavy drapes & pelmet
7.8	0.13	6.32	6.32	5.46	4.20	2.18
7.6	0.13	6.19	6.19	5.36	4.14	2.17
7.4	0.14	6.06	6.06	5.26	4.08	2.15
7.2	0.14	5.92	5.92	5.16	4.02	2.13
7.0	0.14	5.79	5.79	5.05	3.95	2.11
6.8	0.15	5.65	5.65	4.95	3.89	2.10
6.6	0.15	5.51	5.51	4.84	3.82	2.08
6.4	0.16	5.37	5.37	4.73	3.76	2.06
6.2	0.16	5.23	5.23	4.62	3.69	2.04
6.0	0.17	5.08	5.08	4.51	3.61	2.01
5.8	0.17	4.94	4.94	4.40	3.54	1.99
5.6	0.18	4.79	4.79	4.28	3.47	1.97
5.4	0.19	4.65	4.65	4.16	3.39	1.94
5.2	0.19	4.50	4.50	4.04	3.31	1.91
5.0	0.20	4.35	4.35	3.92	3.23	1.89
4.8	0.21	4.20	4.20	3.80	3.14	1.86
4.6	0.22	4.04	4.04	3.67	3.05	1.83
4.4	0.23	3.89	3.89	3.54	2.96	1.79
4.2	0.24	3.73	3.73	3.41	2.87	1.76
4.0	0.25	3.57	3.57	3.28	2.78	1.72
3.8	0.26	3.41	3.41	3.14	2.68	1.69
3.6	0.28	3.25	3.25	3.01	2.58	1.65
3.4	0.29	3.09	3.09	2.86	2.47	1.60
3.2	0.31	2.92	2.92	2.72	2.37	1.56
3.0	0.33	2.75	2.75	2.58	2.26	1.51
2.8	0.36	2.58	2.58	2.43	2.14	1.46
2.6	0.38	2.41	2.41	2.27	2.02	1.40
2.4	0.42	2.24	2.24	2.12	1.90	1.34

ADDITIONS

Table ACT 7.1.4.1 Glazing unit U-Values — continued

Glazing unit (not taking account of any window treatments)		Improved U-Values with window treatments				
		A	B	C	D	E
U-Value	R-Value	Holland blinds only	Closed weave curtains only	Heavy drapes only	Closed weave curtains & pelmet	Heavy drapes & pelmet
2.2	0.45	2.06	2.06	1.96	1.77	1.27
2.0	0.50	1.89	1.89	1.80	1.64	1.20
1.8	0.56	1.71	1.71	1.64	1.50	1.13
1.6	0.63	1.53	1.53	1.47	1.36	1.05
1.4	0.71	1.34	1.34	1.30	1.21	0.96
1.2	0.83	1.16	1.16	1.13	1.06	0.86
1.0	1.00	0.97	0.97	0.95	0.90	0.75
0.8	1.25	0.78	0.78	0.77	0.74	0.63
0.6	1.67	0.59	0.59	0.58	0.56	0.50

Notes:

1. Values in the table may be interpolated to more accurately reflect U-Values.
2. Closed weave curtains have threads or yarns that generally abut, producing a fabric with negligible interstices. Thus, light, air and water pass through a closed weaved cotton fabric, but with significant filtering, unless the fabric is treated to block their passage; and they prevent visual detail being seen by eye through their fabric if woven from opaque thread or yarn. Closed weave curtains do not include open weave curtains, as open weave curtain fabric is woven so that warp threads rarely abut each other, leaving interstices in the fabric, which includes lace, sheer or net fabrics. Open weave curtains provide negligible change to the *Total System U-Value*.
3. Heavy drapes permit no or negligible visible or UV light to pass through their fabric, which may include a composite of layered materials. They also do not readily allow air to pass through. They include closed weave heavy fabrics, such as velvet or velour or heavy cotton or comparable synthetics, with a rubber, acrylic, or similar, solar blocking backing layer bonded to the fabric. The presence of a light source, including the sun, cannot be detected by an unaided eye through the fabric. Another requirement of heavy drapes is to have sufficient inertia to maintain a barrier to air movement by remaining relatively stationary in a draft.
4. Drapes or curtains must fully cover the window and form part of an enclosure of the layer of air between the drape or curtain and window to minimise air movement caused by convection air currents and air movement cause by HVAC systems, fans, or use of the room. That is achieved where curtains or drapes—
 - (a) are fully within and abut the window recess (reveals) and abut the reveals, head and sill; or

ADDITIONS

Table ACT 7.1.4.1 Glazing unit U-Values — continued

Glazing unit (not taking account of any window treatments)		Improved U-Values with window treatments				
		A	B	C	D	E
U-Value	R-Value	Holland blinds only	Closed weave curtains only	Heavy drapes only	Closed weave curtains & pelmet	Heavy drapes & pelmet
(b)		overlap the side edges of the window by at least 150 mm, or abut a return wall if the window is in a re-entrant corner, and abut the floor; and				
(c)		close together (where openable) with no, or with negligible gaps.				
		For the purposes of this note, a drape or curtain is taken to abut a surface where the drape or curtain is not more than 10 mm from that surface.				
5.	Pelmet must be box pelmet and must work in combination with the curtain or drape to enclose the top of a curtain or drape to prevent air plunging by convection from beside or above the pelmet to the window, and must extend to the width of the window plus any required curtain overlap of the window edge. It must overlap the top of the curtain by 50 mm or more.					

ACT 7.1.5 Building sealing—application of Part 3.12.3

- (a) In applying Part 3.12.3.6 to an addition or extension all requirements of the part must be satisfied except as provided in (b) or (c) below.
- (b) If the addition or extension houses an evaporative cooler to which 3.12.3.6 applies, the evaporative cooler must comply with 3.12.3.6 unless it—
- (i) has been relocated from the existing part of the building as part of constructing the addition or extension; and
 - (ii) was not required to meet a provision like 3.12.3.6 when it was previously installed in the existing part of the building; and
 - (iii) does not have a self-closing damper or the like; and
 - (iv) has all outlets serving a heated space or a habitable room, in the addition or extension, provided with an automatic means, or a readily accessible manual means, of closing the outlet or the duct serving the outlet, such as a closable baffle or closable louvers on an outlet register. For this provision, an outlet with a manual means of closure is readily accessible if it is mounted in the ceiling of a room, and can be closed by a reasonable person standing on a step ladder and activating a baffle closer or by closing movable louvers or the like, by hand without a tool.
- (c) If the addition or extension contains a heated space or habitable room to which 3.12.3.6 applies, that is served by an evaporative cooler, the evaporative cooler must comply with 3.12.3.6 unless it—
- (i) served, and continues to serve, the existing part of the building; and
 - (ii) was not required to meet a provision like 3.12.3.6 when it was previously installed in the existing part of the building; and
 - (iii) does not have a self-closing damper or the like; and

ADDITIONS

- (iv) has all outlets serving a heated space or a habitable room in the addition or extension provided with an automatic means, or readily accessible manual means, of closing the outlet, or the duct serving the outlet, such as a closable baffle or closable louvers on an outlet register. For this provision, an outlet with a manual means of closure is readily accessible if it is mounted in the ceiling of a room, and can be closed by a reasonable person standing on a step ladder and activating a baffle closer or by closing movable louvers or the like, by hand without a tool.

ACT 7.1.6 Services—application of Part 3.12.5

- (a) In applying **Part 3.12.5** to an addition or extension all requirements of the part must be satisfied except as provided otherwise in (b) or (c) below.
- (b) If the addition or extension houses or has mounted on it or in association with it, a heater or pump to which **3.12.5.4**, **3.12.5.6** or **3.12.5.7** applies, the heater or pump must comply with those provisions unless—
 - (i) the service is a heater or pump that has been relocated from the existing part of the building as part of constructing the addition or extension; and
 - (ii) the heater or pump was not required to meet a provision like **3.12.5.4** when it was previously installed in the existing part of the building; and
 - (iii) the heater or pump does not comply with **3.12.5.4**, **3.12.5.6** or **3.12.5.7**, and
 - (iv) where the heater or pump serves the addition or extension through a hot water supply system, piping, or duct to which **Part 3.12.5** applies, the portion of the system, piping or duct that is within, or mounted on or in association with, the addition or extension complies with that Part.
- (c) If the addition or extension is served by a heater or pump to which **3.12.5.4**, **3.12.5.6** or **3.12.5.7** applies, the heater or pump must comply with those provisions unless—
 - (i) the heater or pump served, and continues to serve, the existing part of the building; and
 - (ii) the heater or pump was not required to meet a provision like **3.12.5.4** when it was previously installed in the existing part of the building; and
 - (iii) the heater or pump does not comply with **3.12.5.4**, **3.12.5.6** or **3.12.5.7**; and
 - (iv) where the heater or pump serves the addition or extension through a hot water supply system, piping, or duct to which **Part 3.12.5** applies, the portion of the system, piping or duct that is within, or mounted on or in association with, the addition or extension complies with that part.

Explanatory information:

Example for **ACT 7.1.6**.

A house has a existing evaporative air-conditioner, ducted gas central space heater, electric resistance storage water heater, and electric lighting. The house is to be extended by adding a new bedroom with ensuite bathroom, and a small section of hallway. The extension must comply fully with **Part 3.12.5**, except that the following approach to the use of concessions under **ACT 7** could apply.

A new duct will be run from the nearest existing air-conditioner duct to an outlet in the new bedroom. When the existing air-conditioner was installed in 2003 it was not required to have a self-closing damper or the like, and it does not have one. Such a damper or the like does not need to be provided as otherwise required by **3.12.3.6**, because of **ACT 7.1.5(b)**. The new outlet in the bedroom will be mounted in the ceiling. To comply with **ACT 7.1.5(b)**, the

new outlet of the air-conditioner duct will have an outlet register with manually closable baffle that is actuated by turning a knob on the register outlet while standing on a step ladder. When the space heating is operating, heat loss from hot air rising up through the register and out to the atmosphere through the air-conditioner can be reduced by closing the register baffle. The extent of the new duct that is contained within the extension will have to comply with **3.12.5.3**, which is about insulation and sealing of heating and cooling ducts. That will reduce efficiency losses as cooled air travels along the new duct.

The new ensuite's shower and hand basin will be serviced with hot water from new piping connected to the nearest existing hot water piping from the existing water heater. **ACT 7.1.6** permits the existing water heater to be used to serve the extension even if the water heater fails to comply with **3.12.5.6**, which is about energy source of water heaters and other matters. However, the portions of the new piping that are within the extension must comply with **3.12.5.1(a)**, which covers insulation of piping. That will reduce efficiency losses from hot water in the pipe losing heat.

Artificial lighting of a new hallway will rely on light from an existing light fitting located in the existing part of the house. Because of **ACT 7.1.6(b)**, artificial lighting of the new hallway does not have to comply with **3.12.5.5**, which includes limitations of the power density of lamps or illumination. However, new artificial lights in the form of electric light fittings in the new bedroom and new en-suit must comply with **3.12.5.5** insofar as it applies to the new extension, other than the new hallway.

Footnote: OTHER LEGISLATION AFFECTING BUILDINGS

In addition to any applicable provisions of the Building Act 2004 and this Code, there are a number of other legislative technical requirements affecting the design, construction and/or performance of buildings that practitioners may need to be aware of, including, but not necessarily limited to, the following list. Additional legislative instruments such as regulations, codes and standards may exist under the legislation listed.

1. Construction Occupations

1.1 Administering Agency

Environment and Planning Directorate

Relevant Legislation

Construction Occupations (Licensing) Act 2004

2. Dangerous Substances

2.1 Administering Agency

Chief Minister, Treasury and Economic Development Directorate

Justice and Community Safety Directorate

Relevant Legislation

Dangerous Substances Act 2004 (expected to be superseded in early 2015)

3. Electricity and Gas Safety

3.1 Administering Agency

ADDITIONS

Environmental and Planning Directorate

Relevant Legislation

Electricity Safety Act 1971

Gas Safety Act 2000

4. Environmental Protection and Nature Conservation

4.1 Administering Agency

Environment and Planning Directorate

Relevant Legislation

Environment Protection Act 1997

Nature Conservation Act 1980

5. Fences and Party Walls

5.1 Administering Agency

Justice and Community Safety Directorate

Relevant Legislation

Common Boundaries Act 1981

6. Fire Safety

6.1 Administering Agency

Justice and Community Safety Directorate

Chief Minister, Treasury and Economic Development Directorate

Relevant Legislation

Emergencies Act 2004

7. Heritage Conservation

7.1 Administering Agency

Environment and Planning Directorate

Relevant Legislation

Heritage Act 2004

8. Land Use and Development Control

6.1 Administering Agency

Environment and Planning Directorate

Relevant Legislation

Planning and Development Act 2007

Unit Titles Act 2001

ADDITIONS

9. Liquor Premises**9.1 Administering Agency**

Justice and Community Safety Directorate

Relevant Legislation

Liquor Act 2010

10. Machinery, Scaffolding and Lifts**10.1 Administering Agency**

Chief Minister, Treasury and Economic Development Directorate

Justice and Community Safety Directorate

Relevant Legislation

Machinery Act 1949

Scaffolding and Lifts Act 1912

11. Occupational Health and Safety**11.1 Administering Agency**

Chief Minister, Treasury and Economic Development Directorate

Justice and Community Safety Directorate

Relevant Legislation

Work Health and Safety Act 2011 (expected to be superseded in early 2015)

12. Plumbing and Drainage**12.1 Administering Agency**

Environment and Planning Directorate

Relevant Legislation

Water and Sewerage Act 2000

13. Public Health**13.1 Administering Agency**

Health Directorate

Relevant Legislation

Public Health Act 1997

14. Public Unleased Land and Roads**14.1 Administering Agency**

Territory and Municipal Services Directorate

Relevant Legislation

Public Unleased Land Act 2013

ADDITIONS

15. Utilities**15.1 Administering Agency**

Environment and Planning Directorate

Justice and Community Safety Directorate

Territory and Municipal Services Directorate

Chief Minister, Treasury and Economic Development Directorate

Relevant Legislation

Utilities Act 2000

16. Waste**16.1 Administering Agency**

Territory and Municipal Services Directorate

Relevant Legislation

Waste Minimisation Act 2001

17. Water and Sewerage**17.1 Administering Agency**

Environment and Planning Directorate

Relevant Legislation

Water and Sewerage Act 2000

CONTENTS

NEW SOUTH WALES

New South Wales Additions

NSW 1 Garage Top Dwellings

NSW 2 Energy Efficiency

NSW 2.6 Energy Efficiency Performance Provisions

NSW 3.12 Energy Efficiency Acceptable Construction

Footnote: Other Legislation Affecting Buildings

ADDITIONS

NEW SOUTH WALES ADDITIONS

Application of New South Wales additions

This Appendix contains additional provisions for application in New South Wales as follows:

NSW 1 GARAGE TOP DWELLINGS

Purpose

The purpose of **NSW 1** is to provide a suitable level of fire and life safety to occupants of a *garage top dwelling* located above a non-appurtenant *private garage*. This form of construction is not explicitly addressed in the national provisions and therefore an Addition has been provided to include a *Building Solution* for this particular construction configuration. However, unless otherwise stated, all applicable national provisions apply to these dwellings.

A dwelling located above a non-appurtenant *private garage* is a permissible type of development under the NSW planning system. This Addition supports and compliments NSW planning initiatives.

Note:

NSW 1 contains *Deemed-to-Satisfy Provisions* additional to those contained in **Section 3** for buildings which are used as *garage top dwellings* and *private garages* which are attached to or associated with *garage top dwellings*.

ADDITIONS

NSW 1

GARAGE TOP DWELLINGS PERFORMANCE PROVISIONS

OBJECTIVE

The provisions of the national BCA *Objective O2.3* are applicable in NSW.

FUNCTIONAL STATEMENTS

The provisions of the national BCA *Functional Statements F2.3.1* and *F2.3.2* are applicable in NSW.

PERFORMANCE REQUIREMENTS

The provisions of the national BCA *Performance Requirements P2.3.1* and *P2.3.2* are applicable in NSW.

NSW 1.1 GARAGE TOP DWELLINGS ACCEPTABLE CONSTRUCTION PRACTICE

Appropriate *Performance Requirements*

Where an *Alternative Solution* to **NSW 1.1** is proposed, that proposal must comply with—

- (a) *Performance Requirement P2.3.1*; and
- (b) *Performance Requirement P2.3.2*; and
- (c) relevant *Performance Requirements* determined in accordance with **1.0.10**.

NSW 1.1.0 Definitions

The following definitions are used in this Part:

Fire-protective covering means—

- (a) 13 mm fire-protective grade plasterboard; or
- (b) 12 mm cellulose cement flat sheeting complying with AS/NZS 2908.2 or ISO 8336; or
- (c) 12 mm fibrous plaster reinforced with 13 mm x 13 mm x 0.7 mm galvanised steel wire mesh located not more than 6 mm from the exposed face; or
- (d) other material not less fire-protective than 13 mm fire-protective grade plasterboard, fixed in accordance with the normal trade practice for a *fire-protective covering*.

Garage top dwelling means a Class 1a dwelling located above a Class 10a *private garage* which is not appurtenant to that Class 1a dwelling and includes any internal entry stair serving the *garage top dwelling*.

Resistance to the incipient spread of fire, in relation to a ceiling membrane, means the ability of the membrane to insulate the space between the ceiling and roof, or ceiling and floor above, so as to limit the temperature rise of materials in this space to a level which will not permit the rapid and general spread of fire throughout the space.

NSW 1.1.1 Fire separation

- (a) A *garage top dwelling* must be separated from a non-appurtenant *private garage* by a floor complying with **NSW 1.1.2**.
- (b) Where a *garage top dwelling* is served by an internal stair, the *garage top dwelling* must be separated from a non-appurtenant *private garage* by a wall complying with **NSW 1.1.3**.
- (c) Where a *garage top dwelling* is located above both appurtenant and non-appurtenant *private garages*—
 - (i) in addition to a floor *required* by (a), the *private garages* must be separated with a wall complying with **NSW 1.1.3**; or
 - (ii) where a *garage top dwelling* is not served by an internal stair, the *garage top dwelling* may be separated from the *private garages* by a floor complying with **NSW 1.1.2**.

ADDITIONS

NSW 1.1.2 Construction of floors

- (a) A floor *required* by **NSW 1.1.1(a)** or **(c)(ii)** must—
- (i) have an FRL of not less than 30/30/30 when tested from the underside; or
 - (ii) have a *fire-protective covering* on the underside of the floor, including beams incorporated in it; or
 - (iii) be a floor/ceiling system incorporating a ceiling which has a *resistance to the incipient spread of fire* to the space above itself of not less than 60 minutes.
- (b) Where a floor subject to **(a)(i)** depends on direct vertical or lateral support from another part to maintain its FRL, that supporting part must have an FRL of not less than 30/-/-.
- (c) Where a service passes through a floor referred to in **(a)**, the penetration must not reduce the fire performance of the floor or covering.

NSW 1.1.3 Construction of walls

- (a) A wall *required* by **NSW 1.1.1(b)** or **(c)(i)** must—
- (i) have an FRL of not less than 30/30/30 when tested from the non-appurtenant *private garage* side; or
 - (ii) be of masonry construction not less than 90 mm thick.
- (b) A wall subject to **(a)** must—
- (i) commence at the footings or ground slab; and
 - (ii) extend to the underside of a floor complying with **NSW 1.1.2**.
- (c) A wall referred to in **(a)(i)**, if of *lightweight construction* must be tested in accordance with **Specification C1.8** of BCA Volume One.
- (d) Where a service passes through a wall referred to in **(a)**, the penetration must not reduce the fire performance of the wall.
- (e) A wall *required* by **NSW 1.1.1(b)** or **(c)(i)** need not comply with **3.7.1.8**.

NSW 1.1.4 Heat alarms

- (a) A heat alarm must be installed in a *private garage* that is not appurtenant to and located below, a *garage top dwelling*.
- (b) A heat alarm required by **(a)** must—
- (i) be located on or near the ceiling; and
 - (ii) comply with AS 1603.3; and
 - (iii) be connected to the consumer mains power supplying the *garage top dwelling* where consumer mains power is supplied to the building; and
 - (iv) be interconnected to and activate the *garage top dwelling* smoke alarms *required* by **3.7.2.3**.
- (c) Durable notices must be permanently fixed to the *garage top dwelling* and non-appurtenant *private garage* in prominent locations, indicating that—
- (i) a heat alarm is installed in the non-appurtenant *private garage*; and
 - (ii) the heat alarm is interconnected to the *garage top dwelling* smoke alarms.

NEW SOUTH WALES ADDITIONS

NSW 2 ENERGY EFFICIENCY

Note 1.

In NSW, Class 1 and 2 buildings, Class 4 parts of buildings, and certain Class 10 buildings are subject to BASIX (the Building Sustainability Index), the web-based planning tool designed to assess the potential performance of these buildings against a range of sustainability indices including thermal comfort and energy. Commitments made under BASIX become a condition of the relevant development consent or complying development certificate.

BASIX applies to these types of new buildings in NSW; to alterations and additions to buildings of those classes where the work is subject to BASIX; and also where an applicant elects to comply with BASIX.

The following provisions are therefore designed to complement requirements that arise under BASIX and which are implemented via the development consent.

Where BASIX is not applied to alterations and additions to these types of buildings, the provisions will also complement council development controls that require energy efficiency measures to be incorporated as part of the alterations and additions. For example: [NSW Part 3.12.1](#) specifies installation requirements for, and the standards that must be met by, insulation required by any of the foregoing.

Note 2.

All definitions in the national BCA that are applicable to the national BCA [Parts 2.6](#) and [3.12](#) are also applicable to [NSW Parts 2.6](#) and [3.12](#).

NSW PART 2.6 ENERGY EFFICIENCY PERFORMANCE PROVISIONS

OBJECTIVE

The provisions of the national BCA Objective **O2.6** are applicable in NSW.

FUNCTIONAL STATEMENTS

The provisions of the national BCA Functional Statement **F2.6** are applicable in NSW.

Delete the Performance Requirements and Verification Methods of Part 2.6 and substitute NSW provisions as follows:

PERFORMANCE REQUIREMENTS

NSW P2.6.1(a) Building Fabric

- (i) Thermal insulation in a building must be installed in a manner and have characteristics, which facilitate the efficient use of energy for artificial heating and cooling.
- (ii) A building must have, to the degree necessary, thermal breaks installed between the framing and external cladding, to facilitate efficient thermal performance of the building envelope.

Application:

- (a) **NSW P2.6.1(a)** only applies to thermal insulation in a Class 1 or 10 building where a development consent specifies that the insulation is to be provided as part of the development.
- (b) In **(a)**, the term development consent has the meaning given by the Environmental Planning and Assessment Act 1979.
- (c) **NSW P2.6.1(a)(ii)** only applies to a metal framed roof and a metal framed wall.

Explanatory Information:

- (i) In NSW, provision of thermal insulation of the building fabric may be nominated as a commitment on a BASIX (Building Sustainability Index) Certificate and form part of the conditions of development consent or complying development certificate relating to the development.
- (ii) BASIX is applicable to alterations and additions the cost of which exceeds specified minimum values, or where an applicant elects to comply with BASIX. Where BASIX is not applicable, a council's development controls may also specify the provision of thermal insulation in such alterations or additions.
- (iii) Thermal breaks between metal framing and cladding material of minimum thickness will reduce energy loss and contribute to the efficient thermal performance of the building.

NSW P2.6.1(b) Building Sealing

A building must have, to the degree necessary, a level of building sealing against air leakage to facilitate the efficient use of energy for artificial heating and cooling appropriate to—

- (i) the function and use of the building; and
- (ii) the internal environment; and
- (iii) the geographic location of the building.

Limitation:

NSW P2.6.1(b) does not apply to—

- (a) existing buildings being relocated; or
- (b) Class 10a buildings—
 - (i) without a *conditioned space*; or
 - (ii) for the accommodation of vehicles; or
- (c) parts of buildings that cannot be fully enclosed; or
- (d) a permanent building opening, in a space where a gas appliance is located, that is necessary for the safe operation of a gas appliance; or.
- (e) a building in *climate zones* 2 and 5 where the only means of *air-conditioning* is by using an evaporative cooler.

Explanatory Information:

1. The term "cannot be fully enclosed" means parts of buildings with permanent openings such as balconies, shade rooms, rooms with fixed louvres, mesh or other material that allows air flow. Adjustable louvres are considered to provide full enclosure to the opening they accommodate.

Such rooms are unlikely to be conditioned given the high air flow rates; therefore application of the *Performance Requirement* to these parts of buildings would not result in reduction in energy use.

2. Appropriate ventilation for gas appliances can be obtained from relevant legislation, referenced standards and product installation manuals.

ADDITIONS

NSW P2.6.2 Services

Domestic services, including any associated distribution system and components must, to the degree necessary, have features that facilitate the efficient use of energy appropriate to—

- (a) the *domestic service* and its usage; and
- (b) the geographic location of the building; and
- (c) the location of the *domestic service*; and
- (d) the energy source.

Limitations:

- (a) **NSW P2.6.2** does not apply to existing services associated with existing buildings being relocated.
- (b) Compliance is not *required* with the national BCA provisions of **P2.6.2(b)** as the sources of energy are regulated under BASIX.

VERIFICATION METHODS

Verification Methods under the BCA are not applicable in NSW. This subject matter is dealt with by BASIX.

ADDITIONS

NSW PART 3.12 ENERGY EFFICIENCY ACCEPTABLE CONSTRUCTION

Delete Part 3.12 and substitute NSW Part 3.12 as follows:

Note:

The definitions that apply to the national BCA [Part 3.12](#) also apply to [NSW Part 3.12](#).

NSW PART 3.12.1 BUILDING FABRIC THERMAL INSULATION

Appropriate *Performance Requirements*

Where an *Alternative Solution* to **NSW 3.12.1** is proposed, that proposal must comply with—

- (a) *Performance Requirement NSW P2.6.1(a)*; and
- (b) relevant *Performance Requirements* determined in accordance with **1.0.10**.

NSW 3.12.1 Application of NSW Part 3.12.1

- (a) Compliance with **NSW 3.12.1.1** satisfies **NSW P2.6.1(a)** for thermal insulation and thermal breaks.
- (b) **NSW PART 3.12.1** only applies to thermal insulation in a Class 1 or 10 building where a development consent specifies that the insulation is to be provided as part of the development.
- (c) In **(b)**, the term development consent has the meaning given by the Environmental Planning and Assessment Act 1979.
- (d) The *Deemed-to-Satisfy Provisions* of this Part for thermal breaks apply to all Class 1 buildings and Class 10a buildings with a *conditioned space*.

NSW 3.12.1.1 Compliance with BCA provisions

- (a) Thermal insulation in a building must comply with the national BCA provisions of **3.12.1.1**.
- (b) A thermal break must be provided between the external cladding and framing in accordance with national BCA provisions of—
 - (i) **3.12.1.2(c)** for a metal framed roof; and
 - (ii) **3.12.1.4(b)** for a metal framed wall.
- (c) Compensation for reduction in ceiling insulation must comply with the national BCA provisions of **3.12.1.2(e)**.
- (d) A floor with an in-slab or in-screed heating or cooling system must comply with the national BCA provisions of—
 - (i) **3.12.1.5(a)(ii), (iii)** and **(e)** for a suspended floor; or
 - (ii) **3.12.1.5(c), (d)** and **(e)** for a concrete slab-on-ground.

NSW PART 3.12.2 EXTERNAL GLAZING

Note:

The national BCA [Part 3.12.2](#) does not apply in NSW as the subject matter is dealt with by BASIX.

NSW PART 3.12.3 BUILDING SEALING

Appropriate *Performance Requirements*

Where an *Alternative Solution* to **NSW 3.12.3** is proposed, that proposal must comply with—

- (a) *Performance Requirement NSW P2.6.1(b)*; and
- (b) relevant *Performance Requirements* determined in accordance with **1.0.10**.

NSW 3.12.3 Application of NSW Part 3.12.3

- (a) Compliance with **NSW 3.12.3.1** satisfies **NSW P2.6.1(b)** for building sealing.
- (b) **NSW Part 3.12.3** is not applicable to—
 - (i) existing buildings being relocated; or
 - (ii) Class 10a buildings—
 - (A) without a *conditioned space*; or
 - (B) for the accommodation of vehicles; or
 - (iii) parts of buildings that cannot be fully enclosed; or
 - (iv) a permanent building opening, in a space where a gas appliance is located, that is necessary for the safe operation of a gas appliance; or
 - (v) a building in *climate zones* 2 and 5 where the only means of *air-conditioning* is by using an evaporative cooler.

NSW 3.12.3.1 Compliance with BCA provisions

The sealing of a building must comply with the national BCA provisions **3.12.3.1** to **3.12.3.6**.

Explanatory Information:

1. The term "cannot be fully enclosed" means parts of buildings with permanent openings such as balconies, shade rooms, rooms with fixed louvres, mesh or other material that allows air flow. Adjustable louvres are considered to provide full enclosure to the opening they accommodate.

Such rooms are unlikely to be conditioned given the high air flow rates; therefore applications of the *Performance Requirement* to these parts of buildings would not result in reduction in energy use.
2. Appropriate ventilation for gas appliances can be obtained from relevant legislation, referenced standards and product installation manuals.

NSW PART 3.12.4 AIR MOVEMENT

Note:

The national BCA [Part 3.12.4](#) does not apply in NSW as the subject matter is dealt with by BASIX.

NSW PART 3.12.5 SERVICES

Appropriate *Performance Requirements*

Where an *Alternative Solution* to **NSW 3.12.5** is proposed, that proposal must comply with—

- (a) *Performance Requirement NSW P2.6.2*; and
- (b) relevant *Performance Requirements* determined in accordance with **1.0.10**.

NSW 3.12.5 Application of NSW Part 3.12.5

- (a) Compliance with **NSW 3.12.5.1** satisfies **NSW P2.6.2** for services.
- (b) **NSW Part 3.12.5** is not applicable to existing services associated with existing buildings being relocated.

NSW 3.12.5.1 Compliance with BCA provisions

Services must comply with the national BCA provisions **3.12.5.0** to **3.12.5.3**.

Explanatory Information:

Compliance is not *required* with the national BCA provisions **3.12.5.4** to **3.12.5.8** as those matters are regulated under BASIX.

Footnote: OTHER LEGISLATION AFFECTING BUILDINGS

In addition to any applicable provisions of the Environmental Planning and Assessment Act 1979, the Environmental Planning and Assessment Regulation 2000 and this Code, there is a variety of other regulatory provisions, including legislation, regulation and departmental policies that impose requirements affecting the design, construction and/or performance of buildings in NSW

The following is a non-definitive list of such provisions. It does not include Commonwealth provisions that may apply in NSW, nor planning and environmental standards that may impose building requirements in individual circumstances. It is meant as an indicative guide only and is not to be relied upon in any way as a substitute for further research, investigation and legal advice needed to determine building standards in individual circumstances.

1. Boarding Houses

1.1 Administering Agency

Department of Family and Community Services – Ageing, Disability and Home Care

Relevant Legislation

Boarding Houses Regulation 2013

ADDITIONS

2. Children's Services

2.1 Administering Agency

NSW Department of Education and Communities

Relevant Legislation

Children (Education and Care Services National Law Application) Act 2010

Children (Education and Care Services) Supplementary Provisions Regulation 2012

3. Crown Land – Construction Approval

3.1 Administering Agency

Department of Primary Industries – NSW Crown Lands Division

Relevant Legislation

Crown Lands Act 1989

Crown Lands Regulation 2006

3.2 Administering Agency

NSW Rural Fire Service

Relevant Legislation

Rural Fires Act 1997

4. Dining Rooms

4.1 Administering Agency

NSW Food Authority

Relevant Legislation

Food Regulation 2010

5. Electrical Installations

5.1 Administering Agency

NSW Fair Trading

Relevant Legislation

Electricity (Consumer Safety) Regulation 2006

Electricity (Consumer Safety) Act 2004

5.2 Administering Agency

WorkCover Authority of NSW

Relevant Legislation

Work Health and Safety Regulation 2011

6. Fire Prevention in Existing Buildings

6.1 Administering Agency

ADDITIONS

Department of Planning and Environment

Relevant Legislation

Environmental Planning and Assessment Act 1979

Environmental Planning and Assessment Regulation 2000

7. Gas Installations

7.1 Administering Agency

Department of Trade and Investment, Regional Infrastructure – Resources and Energy Division

Relevant Legislation

Gas Supply Act 1996

Gas Supply (Safety and Network Management) Regulation 2013

7.2 Administering Agency

NSW Fair Trading

Relevant Legislation

Gas Supply (Consumer Safety) Regulation 2012

8. Historic Buildings

8.1 Administering Agency

Office of Environment and Heritage

Relevant Legislation

Heritage Regulation 2012

9. Lift Installations

9.1 Administering Agency

WorkCover Authority of NSW

Relevant Legislation

Work Health and Safety Regulation 2011

10. Moveable Dwellings (in Caravan Parks)

10.1 Administering Agency

Office of Local Government

Relevant Legislation

Local Government Act 1993

10.2 Administering Agency

Department of Planning and Environment

Relevant Legislation

ADDITIONS

Local Government (Manufactured Home Estates, Caravan Parks, Camping Grounds and Moveable Dwellings) Regulation 2005

11. Work Health and Safety

11.1 Administering Agency

WorkCover Authority of NSW

Relevant Legislation

Work Health and Safety Regulation 2011

12. Planning Controls

12.1 Administering Agency

Department of Planning and Environment

Relevant Legislation

Environmental Planning and Assessment Act 1979

Environmental Planning and Assessment Regulation 2000

13. Sanitary Plumbing, Water Supply and Sewerage

13.1 Administering Agency

Office of Local Government

Relevant Legislation

Local Government Act 1993

Local Government (General) Regulation 2005

13.2 Administering Agency

NSW Fair Trading

Relevant Legislation

Plumbing and Drainage Act 2011

Plumbing and Drainage Regulation 2012

Approval to Connect to Network Utility Operator's System

Refer to the Network Utility Operator for the current Act & Regulation

Hunter Water Act 1991

Sydney Water Act 1994

Water Industry Competition Act (WICA) 2006

14. Septic Tank Installations

14.1 Administering Agency

Office of Local Government

Relevant Legislation

Local Government Act 1993

ADDITIONS

Local Government (General) Regulation 2005

15. Sleeping Accommodation**15.1 Administering Agency**

NSW Ministry of Health

Relevant Legislation

Public Health Regulation 2012

16. Swimming Pool Fences**16.1 Administering Agency**

Office of Local Government

Relevant Legislation

Swimming Pools Act 1992

Swimming Pools Regulation 2008

ADDITIONS

CONTENTS

NORTHERN TERRITORY

Footnote: Other Legislation Affecting Buildings

NORTHERN TERRITORY ADDITIONS

The Northern Territory has no additions to the Housing Provisions.

Footnote: OTHER LEGISLATION AFFECTING BUILDINGS

In addition to any applicable provisions of the Building Act, Building Regulations and this Code, there are a number of other legislative technical requirements affecting the design, construction and/or performance of buildings that practitioners may need to be aware of, including, but not necessarily limited to, the following list. Additional legislative instruments such as regulations, codes and standards may exist under the legislation listed.

1. Accommodation

1.1 Administering Agency

Department of Health

Relevant Legislation

Public Health Act

2. Child Care

2.1 Administering Agency

Department of Health

Relevant Legislation

Community Welfare Act

Community Welfare (Child Care) Regulations

3. Crown Land

3.1 Administering Agency

Department of Lands, Planning and the Environment

Relevant Legislation

Crown Lands Act

4. Electrical Installations

4.1 Administering Agency

Department of Business

Relevant Legislation

Electrical Workers and Contractors Act

Electricity Reform Act

Electricity Reform (Safety and Technical) Regulations

ADDITIONS

5. Fences — dividing

5.1 Administering Agency

Department of Attorney-General and Justice

Relevant Legislation

Fences Act

6. Gas Installations

6.1 Administering Agency

NT Worksafe

Relevant Legislation

Work Health Act

Work Health (Occupational Health and Safety) Regulations

7. Historic Building

7.1 Administering Agency

Department of Lands, Planning and the Environment

Relevant Legislation

Heritage Conservation Act

8. Occupational Health and Safety

8.1 Administering Agency

NT Worksafe

Relevant Legislation

Work Health Act

9. Planning Controls

9.1 Administering Agency

Department of Lands, Planning and the Environment

Relevant Legislation

Planning Act

Planning Scheme

10. Plumbing Installations

10.1 Administering Agency

Department of Lands, Planning and the Environment

Relevant Legislation

Plumbers and Drainers Licensing Act

Building Act

ADDITIONS

11. Stormwater Drainage (Municipal Roads)**11.1 Administering Agency**

Council or Municipality in which building is located

Relevant Legislation

Local Government Act

12. Stormwater Drainage (Territory Roads)**12.1 Administering Agency**

Department of Transport

Relevant Legislation

Control of Roads Act

13. Swimming Pools**13.1 Administering Agency**

Department of Lands, Planning and the Environment

Relevant Legislation

Swimming Pool Safety Act

14. Water Supply and Sewage Services**14.1 Administering Agency**

Power and Water Corporation

Relevant Legislation

Water Supply and Sewerage Services Act

ADDITIONS

CONTENTS

QUEENSLAND

Footnote: Other Legislation Affecting Buildings

ADDITIONS

QUEENSLAND ADDITIONS

Queensland has no additions to the *Housing Provisions*.

Footnote: OTHER LEGISLATION AFFECTING BUILDINGS

All legislative technical requirements affecting the design, construction and/or performance of buildings are consolidated into the Building Act 1975 and other legislative instruments under that Act, such as regulations, codes (including this Code) and standards.

CONTENTS

SOUTH AUSTRALIA

Acceptable Construction Manual

SA 1 * * * * *

Health and Amenity

SA 2 Water efficiency

SA 3 Wet Areas

Safe movement and access

SA 4 * * * * *

SA 5 Access for People with a Disability

SA 6 Access for Inspection and Maintenance

Footnote: Other Legislation Affecting Buildings

ADDITIONS

SOUTH AUSTRALIA ADDITIONS

Application of South Australian variations

This Appendix contains additional provisions for application in South Australia as follows:

SA ACCEPTABLE CONSTRUCTION MANUAL

SA 1 * * * * *

This clause has been deliberately left blank.

HEALTH AND AMENITY

SA 2 WATER EFFICIENCY

Limitation:

SA 2 applies to new Class 1 buildings and, extensions to existing Class 1 buildings where the *roof catchment area* is not less than 50 m² —

- (a) located in *Council* areas, excluding the Municipal Council of Roxby Downs and the District Council of Coober Pedy and;
- (b) where an extension incorporates a water closet or a water heater or laundry cold water outlet.

For the purposes of this part, *Council* means: A municipal or district Council as constituted under the Local Government Act 1999.

SA 2.1 PERFORMANCE PROVISIONS

Objective

The *Objective* is to efficiently use all available water supplies.

Functional Statements

A building is to be constructed in a way that efficiently uses all available water supplies to reduce the amount required from the mains reticulated water supply.

Performance Requirements

A building must provide an additional water supply (other than the mains reticulated potable water supply) which must be plumbed to at least a water closet or a water heater or all the cold water laundry outlets.

SA 2.2 ACCEPTABLE CONSTRUCTION PRACTICE

ADDITIONS

SA 2.2.0 Definitions

The following definitions are used in this part:

Rainwater tank means a vessel for the storage of *surface water* collected from the *roof catchment area* of the building.

Roof catchment area means the area of the roof (expressed in square metres), measured on the horizontal (no allowance for slope or vertical surfaces) and includes the plan area of the gutters.

SA 2.2.1 Application

Compliance with the acceptable construction practice provisions of **SA 2.2** for water efficiency satisfies *Performance Requirement SA 2.1*.

SA 2.2.2 Rainwater tank capacity

- (a) Where the *roof catchment area* of the building is not less than 50 m², the building must be designed to ensure that *surface water* run-off from not less than 50m² of the *roof catchment area* is:
 - (i) collected by a drainage system complying with **Clauses 3.5.1** and **3.5.2** of the Building Code of Australia; and
 - (ii) stored in a *rainwater tank*, the storage capacity of which is not less than 1 kilolitre (1000 litres); and
 - (iii) plumbed to at least a water closet or a water heater or all laundry cold water outlets.
- (b) Where the *roof catchment area* of the building is less than 50m², all the *surface water* run-off from the *roof catchment area* must be collected, stored and plumbed in accordance with **(a)(i)**, **(a)(ii)** and **(a)(iii)**.

Explanatory information:

Clause SA 2.2.2 requires the *rainwater tank* to be plumbed to a water closet, water heater or all laundry cold water outlets. The South Australian Water Corporation regulates the plumbing work required to comply with this provision under the *Waterworks Act 1932* and the *Waterworks Regulations 1996*.

SA 2.2.3 Rainwater tank overflow

The *rainwater tank* must be fitted with an overflow device that disposes of overflow from the *rainwater tank* in accordance with:

- (a) any specific requirements of the relevant authority; and
- (b) **Part 3.1.2** of the Building Code of Australia.

SA 2.2.4 Rainwater tank water quality

The inlet and overflow of the *rainwater tank* must be fitted with mosquito proof, non-degradable screens.

Explanatory information:

Clause SA 2.2.4 requires the fitting of mosquito proof, non-degradable screens to the *rainwater tank*. The quality of the water stored in the *rainwater tank* should be managed in accordance with the Department of Health and Ageing monograph titled "*Guidance on the use of rainwater tanks*".

ADDITIONS

SA 2.2.5 Rainwater tank stands

Where a *rainwater tank* is supported on a stand or other structure, the supporting structure must comply with [Clause 3.11.2](#).

SA 3 WET AREAS

SA 3.1 PERFORMANCE PROVISIONS

Objective

As per [Section 2 Objectives](#) for *wet areas*.

Functional Statements

As per [Section 2 Functional Statement](#) for *wet areas*.

Performance Requirements

Floors in bathrooms, or rooms containing a shower or a sanitary fixture, must be installed in a manner that will prevent accumulation of water on the surface which could create unhealthy or hazardous conditions.

SA 3.2 ACCEPTABLE CONSTRUCTION PRACTICE

SA 3.2.1 Application

[Performance Requirement SA3.1](#) is satisfied for *wet areas* if they comply with [SA 3.2.2](#).

SA 3.2.2 Provision of floor wastes

- (a) Unless exempted by **(b)**, the floor of a *wet area*, room or area containing a *vessel* must be graded to a floor waste.
- (b) A floor need not be graded to a floor waste as *required* by **(a)** if—
 - (i) all *vessels* are provided with in-built overflow protection or have a permanent open trapped connection to the waste system (such as a WC pan); or
 - (ii) the floor drains without ponding to a floor waste within the *shower area*.
- (c) The fall of the floor surface to a floor waste must be—
 - (i) between 1:60 and 1:80 in the *shower area*; and
 - (ii) between 1:80 and 1:100 in other areas.

SAFE MOVEMENT AND ACCESS

SA 4 * * * * *

This clause has been deliberately left blank.

ADDITIONS

SA 5 ACCESS FOR PEOPLE WITH A DISABILITY**Limitation:**

SA 5 applies to Class 1 buildings in developments of 20 or more dwellings.

SA 5.1 PERFORMANCE PROVISIONS**Objective**

Provide, as far as is reasonable, people with safe, equitable and dignified access to a degree necessary to—

- (a) buildings; and
- (b) the services and facilities within.

Functional Statements

A building to a degree necessary is, as far as is reasonable, to provide safe, equitable and dignified access for people to the services and facilities within.

Performance Requirements

Buildings and immediate surrounds must have appropriate features to a degree necessary to enable people with a disability to safely and equitably—

- (a) negotiate the route from the road boundary to and within the building using a wheelchair; and
- (b) have access to spaces within the building, including facilities *required* under **P2.4.3**.

SA 5.2 ACCEPTABLE CONSTRUCTION PRACTICE**SA 5.2.1 Application**

Compliance with the acceptable construction practice provisions of **Part SA 5.2** for access for people with a disability satisfies *Performance Requirement SA 5.1*.

SA Part 5.2 applies to certain Class 1 buildings where access is *required* under **Clause SA 5.2.2**.

SA 5.2.2 Access to buildings

In developments consisting of 20 or more dwellings, access must be provided to and within one dwelling or 5% of the total number of dwellings, whichever is the greater.

SA 5.2.3 Parts of buildings to be accessible

- (a) Access for people with a disability must be provided from the entrance doorway to areas normally used by the occupants. A path of travel providing *required* access must not include a stairway or other impediment which would prevent a person in a wheelchair using it.
- (b) Access, finishes and fittings must comply with the provisions of AS 1428.1.
- (c) In every Class 1 building to which access for people with a disability is *required*, one closet pan and washbasin and one shower must be provided for use by people with a disability.

ADDITIONS

SA 6 ACCESS FOR INSPECTION AND MAINTENANCE

SA 6.1 PERFORMANCE PROVISIONS

Objective

The *Objective* is to safeguard people from injury and illness resulting from the creation of hazardous spaces between buildings.

Functional Statements

The space between buildings must not allow hazardous conditions to arise due to accumulation of rubbish that cannot be readily removed.

Performance Requirements

The space between buildings must be sufficient to allow access for inspection and maintenance to avoid hazardous conditions arising due to accumulation of rubbish that could—

- (a) bridge termite barriers; or
- (b) harbour vermin; or
- (c) create a fire hazard.

SA 6.2 ACCEPTABLE CONSTRUCTION PRACTICE

SA 6.2.1 Application

Compliance with the acceptable construction provision of **SA 6.2** for acceptable separation between buildings for Class 1 and 10 buildings satisfies *Performance Requirement SA 6.1*.

SA 6.2.2 Minimum separation between buildings

Unless the space between external columns is not infilled, every part of an *external wall* of a building must be not less than 600 mm from—

- (a) any boundary of the allotment, unless that wall is on or abutting that boundary; or
- (b) the *external wall* of any other building on the same allotment, unless the two buildings are abutting.

Footnote: OTHER LEGISLATION AFFECTING BUILDINGS

In addition to any applicable provisions of the Development Act 1993, the Development Regulations 2008 and this Code, there are a number of other legislative technical requirements affecting the design, construction and/or performance of buildings that practitioners may need to be aware of, including, but not necessarily limited to, the following list. Additional legislative instruments such as regulations, codes and standards may exist under the legislation listed.

1. Accommodation

1.1 Administering agency

Department for Communities and Social Inclusion

Relevant legislation

Supported Residential Facilities Act 1992

ADDITIONS

Supported Residential Facilities Regulations 2009

2. Asbestos Removal

2.1 Administering agency

SafeWork SA, Department of the Premier and Cabinet

Relevant legislation

Work, Health and Safety Act 2012

Work, Health and Safety Regulations 2012

3. Crown Land

3.1 Administering agency

Department of Environment, Water and Natural Resources

Relevant legislation

Crown Land Management Act 2009

Crown Land Management Regulations 2010

4. Electrical Installations

4.1 Administering agency

Office of the Technical Regulator, Department of State Development

Relevant legislation

Electricity Act 1996

Electricity Regulations 2012

Energy Products Act 2012

Energy Products (Safety and Efficiency) Act 2000

Energy Products (Safety and Efficiency) Regulations 2012

5. Encroachments

5.1 Administering agency

Attorney-General's Department

Relevant legislation

Encroachments Act 1944

6. Fences

6.1 Administering agency

Attorney-General's Department

Relevant legislation

Fences Act 1975

Fences Regulations 2003

ADDITIONS

7. Fire Prevention in Existing Buildings

7.1 Administering agency

Department of Planning, Transport and Infrastructure

Relevant legislation

Development Act 1993

Development Regulations 2008

7.2 Administering agency

SA Fire and Emergency Services Commission

Relevant legislation

Fire and Emergency Services Act 2005

Fire and Emergency Services Regulations 2005

8. Gas Installations

8.1 Administering agency

Office of the Technical Regulator, Department of State Development

Relevant legislation

Gas Act 1997

Gas Regulations 2012

Energy Products Act 2012

Energy Products (Safety and Efficiency) Act 2000

Energy Products (Safety and Efficiency) Regulations 2012

9. Historic Buildings

9.1 Administering agency

Department of Environment, Water and Natural Resources

Relevant legislation

Heritage Places Act 1993

Heritage Places Regulations 2005

10. Housing

10.1 Administering agency

Department for Communities and Social Inclusion

Relevant legislation

Housing Improvement Act 1940

Housing Improvement (Standards) Regulations 2007

ADDITIONS

11. Lift Installations

11.1 Administering agency

Safework SA, Department of the Premier and Cabinet

Relevant legislation

Work, Health and Safety Act 2012

Work, Health and Safety Regulations 2012

12. Occupational Health and Safety

12.1 Administering agency

SafeWork SA, Department of the Premier and Cabinet

Relevant legislation

Work, Health and Safety Act 2012

Work, Health and Safety Regulations 2012

13. Sanitary Plumbing, Water Supply and Sewerage

13.1 Administering agency

Office of the Technical Regulator, Department of State Development

Relevant legislation

Water Industry Act 2012

Water Industry Regulations 2012

14. Septic Tank and Grey Water Installations

14.1 Administering agency

Department for Health and Ageing

Relevant legislation

South Australian Public Health Act 2011

South Australian Public Health (Wastewater) Regulations 2013

15. Subdivision of Property

15.1 Administering agency

Land Services Group, Department of Planning, Transport and Infrastructure

Relevant legislation

Community Titles Act 1996

Community Titles Regulations 2011

Real Property Act 1886

Real Property Regulations 2009

Strata Titles Act 1988

ADDITIONS

Strata Titles Regulations 2003

16. Waste Management and Environment Protection**16.1 Administering agency**

Environment Protection Authority

Relevant legislation

Environment Protection Act 1993

Environment Protection Regulations 2009

CONTENTS

TASMANIA

Fire safety

TAS 1 Non-Combustible Roof Coverings

Health and Amenity

TAS 2 Swimming Pool Water Recirculation and Filtration

Footnote: Other Legislation Affecting Buildings

TASMANIA ADDITIONS

Application of Tasmanian variations

This Appendix contains additional provisions for application in Tasmania as follows:

FIRE SAFETY

Limitation:

Tas 1 does not apply to—

1. roof coverings or canopies of PVC, Acrylic, Polycarbonate and GRP sheeting over a balcony, verandah, carport, covered way, swimming pool, barbecue area, or similar open structure attached to a Class 1 building; or
2. Class 1 buildings on land zoned Rural (except Rural Residential) in the Municipality's or City's sealed Planning Scheme, Effective Interim Order, or Special Planning Order if situated at a distance of not less than 30 m from a wooden building or the allotment boundary or not less than 15 m from other buildings; and
3. where, in accordance with [2.](#), a roof is covered with wood shingles or shakes, the shingles or shakes are underlaid with a material having a *Flammability index* not greater than 2.

TAS 1 NON-COMBUSTIBLE ROOF COVERINGS

TAS 1.1 PERFORMANCE PROVISIONS

Objective

The fire safety *Objective* is to prevent the spread of fire from air-borne embers.

Application:

The *Objective* Provisions of **TAS 1.1** only apply to areas not in a *designated bushfire prone area*.

Functional Statements

Protect Class 1 buildings from air-borne embers.

Application:

The *Functional Statement* Provisions of **TAS 1.1** only apply to areas not in a *designated bushfire prone area*.

Performance Requirements

A Class 1 building must be protected from the spread of fire from air-borne embers from other property by the provision of a *non-combustible* roof covering.

ADDITIONS

Application:

The *Performance Requirement* Provisions of **TAS 1.1** only apply to areas not in a *designated bushfire prone area*.

TAS 1.2 ACCEPTABLE CONSTRUCTION PRACTICE

Tas 1.2.1 Non-combustible roofing

A roof covered with any of the following materials satisfies the *Performance Requirements* of **Tas 1.1**.

- (a) Metal sheeting or tiles.
- (b) Slates.
- (c) Terracotta or cement roofing tiles.
- (d) Fibre cement sheeting or shingles.
- (e) Asphalt shingles except on buildings with rise in storeys exceeding 2.
- (f) Built-up roofing covered with *non-combustible* material.
- (g) Concrete, granolithic, terrazzo, cement mortar, or other similar *non-combustible* materials.

HEALTH AND AMENITY

TAS 2 SWIMMING POOL WATER RECIRCULATION AND FILTRATION

Limitation:

Tas 2 does not apply to a *swimming pool* associated with a Class 1 building if the depth of water is less than 300 mm and the volume of the pool does not exceed 15 m³.

TAS 2.1 PERFORMANCE PROVISIONS

Objective

The *Objective* is to safeguard people from illness or injury arising from the use of a *swimming pool*.

Functional Statements

Swimming pools must provide for the health and safety of swimmers and others.

Performance Requirements

Swimming pools must be provided with an adequate water recirculation, disinfection and filtration system which is suitable and safe to use.

TAS 2.2 ACCEPTABLE CONSTRUCTION PRACTICE

Tas 2.2.1 Application

Compliance with the provisions of **Tas 2.2** for a *swimming pool* associated with a Class 1 building with a depth of water more than 300 mm and volume exceeding 15 m³ satisfies *Performance Requirement Tas 2.1*.

ADDITIONS

Tas 2.2.2 Water recirculation and filtration system

A water recirculation, disinfection and filtration system in a *swimming pool* must provide for—

- (a) the inlet and outlet openings for the purpose of water recirculation to be so located that water movement is continuous from inlet to outlet; and
- (b) * * * * *
- (c) the recirculation of water to be so designed that the pool contents are recirculated not less than once—
 - (i) in 6 hours for an outdoor *swimming pool*; or
 - (ii) in 4 hours for an indoor *swimming pool*; and
- (d) the water filtration rates to not exceed 12 250 L/m² of sand filter bed per hour, or an equivalent rate in other filter media.

Footnote: OTHER LEGISLATION AFFECTING BUILDINGS

All legislative technical requirements affecting the design, construction and/or performance of buildings are consolidated into the Building Act 2000 and other legislative instruments under that Act, such as regulations, codes (including this Code) and standards.

ADDITIONS

CONTENTS

VICTORIA

Footnote: Other Legislation Affecting Buildings

VICTORIA ADDITIONS

Victoria has no additions to the Housing Provisions.

Footnote: OTHER LEGISLATION AFFECTING BUILDINGS

In addition to any applicable provisions of the Building Act 1993, Building Regulations 2006 and this Code, there are a number of other legislative technical requirements affecting the design, construction and/or performance of buildings that practitioners may need to be aware of, including, but not necessarily limited to, the following list. Additional legislative instruments such as regulations, codes and standards may exist under the legislation listed.

1. Accommodation – Residential (Boarding Houses, Guest Houses, Hostels, Motels)

1.1 Administering Agency

Department of Human Services

Municipal council

Relevant Legislation

Public Health and Wellbeing Act 2008

Public Health and Wellbeing Regulations 2009

2. Alpine Resorts

2.1 Administering Agency

Department of Environment and Primary Industries

Alpine Resorts Management Boards

Relevant Legislation

Alpine Resorts (Management) Act 1997

3. Asbestos Removal

3.1 Administering Agency

Victorian WorkCover Authority

Environment Protection Authority

Relevant Legislation

Occupational Health and Safety Act 2004

Environment Protection Act 1970

4. Crown Land

4.1 Administering Agency

Department of Environment and Primary Industries

ADDITIONS

Crown Land committees of management

Relevant Legislation

Crown Land (Reserves) Act 1978

5. Electrical Installations

5.1 Administering Agency

Energy Safe Victoria

Electrical transmission and distribution companies

Relevant Legislation

Electricity Industry Act 2000

Electricity Industry (Residual Provisions) Act 1993

Electricity Safety Act 1998

State Electricity Commission Act 1958

Electricity Safety (Installations) Regulations 2009

Standards Australia Wiring Rules, AS/NZS 3000/3013

6. Fences - dividing

6.1 Administering Agency

Department of Justice

Relevant Legislation

Fences Act 1968

7. Fire Prevention in Existing Buildings

7.1 Administering Agency

Municipal council

Relevant Legislation

Building Act 1993

Building Regulations 2006

8. Gas Installations

8.1 Administering Agency

Energy Safe Victoria

Relevant Legislation

Gas Industry Act 2001

Gas Safety Act 1997

Gas Safety (Gas Installation) Regulations 1999

AS/NZS 5601 – 2013 Gas Installations

ADDITIONS

9. Historic Buildings

9.1 Administering Agency

Department of Planning and Community Development
Executive Director under the Heritage Act 1995

Relevant Legislation

Heritage Act 1995

10. Moveable Dwellings (in Caravan Parks)

10.1 Administering Agency

Department of Justice
Municipal council

Relevant Legislation

Residential Tenancies Act 1997
Residential Tenancies (Caravan Parks and Moveable Dwellings
Registration and Standards) Regulations 1999

11. Occupational Health and Safety

11.1 Administering Agency

Victorian WorkCover Authority

Relevant Legislation

Occupational Health and Safety Act 2004
Occupational Health and Safety Regulations 2007
Codes of practice published by the WorkCover Authority

12. Planning Controls

12.1 Administering Agency

Department of Transport, Planning and Local Infrastructure
Municipal council

Relevant Legislation

Planning and Environment Act 1987
Planning schemes

13. Sanitary Plumbing, Water Supply and Sewerage

13.1 Administering Agency

Victorian Building Authority

Relevant Legislation

Building Act 1993

ADDITIONS

Plumbing Regulations 2008

Plumbing Code of Australia

AS/NZS3500 National Plumbing and Drainage Code

14 Septic Tank Installations

14.1 Administering Agency

Environment Protection Authority

Municipal council

Relevant Legislation

Environment Protection Act 1970

Guidelines For Environmental Management: Code of Practice-Onsite wastewater management

15. Subdivision of Buildings

15.1 Administering Agency

Department of Transport, Planning and Local Infrastructure

Municipal council

Relevant Legislation

Subdivision Act 1988

CONTENTS

WESTERN AUSTRALIA

Heated Water Systems

WA 1.1 * * * * *

WA 1.2 * * * * *

Water Use

WA 2.1 Definitions

WA 2.2 Performance Provisions

WA 2.3 Acceptable Construction Practice

Footnote: Other Legislation Affecting Buildings

WESTERN AUSTRALIA ADDITIONS

Application of Western Australia additions

This appendix contains additional provisions for application in Western Australia as follows:

HEATED WATER SYSTEMS

WA 1.1 * * * * *

This clause has deliberately been left blank.

WA 1.2 * * * * *

This clause has deliberately been left blank.

WATER USE

WA 2.1 DEFINITIONS

The following definitions are used in this Part—

Potable water means water intended for human consumption supplied by a water services provider.

WELS has the meaning given in the Water Efficiency Labelling and Standards Act 2005 of the Commonwealth section 7.

WA 2.2 PERFORMANCE PROVISIONS

Objective

The *Objective* is to reduce water demand by using water efficiently and minimising water wastage.

Functional Statements

To reduce *potable water* demand, a building is to be capable of using *potable water* efficiently and preventing excessive loss of *potable water*.

Performance Requirements

(a) Water use efficiency

A building must have features that, to the degree necessary, facilitate the efficient use of *potable water* appropriate to—

- (i) the geographic location of the building; and
- (ii) the available *potable water* supply for the building; and
- (iii) the function and use of the building.

ADDITIONS

(b) **Water loss prevention**

A building, including any water holding structure, must have features that, to the degree necessary, prevent the excessive loss of *potable water* appropriate to—

- (i) the geographic location of the building; and
- (ii) the available *potable water* supply for the building; and
- (iii) the function and use of the building; and
- (iv) the effects of permanent features such as topography, structures and buildings.

(c) **Heated water use efficiency**

A building must have features that, to the degree necessary, facilitate the efficient use of heated water appropriate to—

- (i) the geographic location of the building; and
- (ii) the available heated water supply for the building; and
- (iii) the function and use of the building.

Application

The Performance Provisions of [WA 2.2](#) apply to Class 1 buildings, associated Class 10a buildings and *swimming pools* associated with a Class 1 building.

A building's water use efficiency is satisfied by complying with [WA 2.3.1](#).

A building's water loss prevention is satisfied by complying with [WA 2.3.2](#).

A building's heated water use efficiency is satisfied by complying with [WA 2.3.3](#).

WA 2.3 ACCEPTABLE CONSTRUCTION PRACTICE

WA 2.3.1 Water use efficiency

- (a) All tap fittings other than bath outlets and garden taps must be a minimum of 4 stars *WELS* rated.
- (b) All showerheads must be a minimum of 3 stars *WELS* rated.
- (c) All sanitary flushing systems must be a minimum of 4 stars *WELS* rated dual flush.

WA 2.3.2 Swimming pool covers and blankets

An outdoor private *swimming pool* or spa associated with a Class 1 building must be supplied with a cover, blanket or the like that—

- (a) is designed to reduce water evaporation; and
- (b) is accredited under the Smart Approved Watermark Scheme governed by the Australian Water Association, the Irrigation Association of Australia, the Nursery and Garden Industry Australia and the Water Services Association of Australia.

WA 2.3.3 Heated water use efficiency

All internal heated water outlets (such as taps, showers and washing machine water supply fittings) must be connected to a heated water system or a re-circulating heated water system with pipes installed and insulated in accordance with AS/NZS 3500: Plumbing and Drainage, Part 4 Heated Water Services. The

pipe from the heated water system or re-circulating heated water system to the furthest heated water outlet must not be more than 20 m in length or 2 litres of internal volume.

Footnote: OTHER LEGISLATION AFFECTING BUILDINGS

In addition to any applicable provisions of the Building Act 2011, Building Regulations 2012 and this Code, there are a number of other legislative technical requirements affecting the design, construction and/or performance of buildings that practitioners may need to be aware of, including, but not necessarily limited to, the following list. Additional legislative instruments such as regulations, codes and standards may exist under the legislation listed.

1. Building

1.1 Administering Agency

Building Commission, Department of Commerce

Relevant Legislation

Building Services (Complaint Resolution and Administration) Act 2011

Building Services (Complaint Resolution and Administration) Regulations 2011

Building Service (Registration) Act 2011

Building Service (Registration) Regulations 2011

2. Caravan Parks and Camping Grounds

2.1 Administering Agency

Department of Local Government

Relevant Legislation

Caravan Park and Camping Grounds Act 1995

Caravan Park and Camping Grounds Regulations 1997

3. Child Care

3.1 Administering Agency

Department for Communities

Relevant Legislation

Child Care Services Act 2007

Child Care Services Regulations 2007

Child Care Services (Child Care) Regulations 2006

Child Care Services (Family Day Care) Regulations 2006

Child Care Services (Outside School Hours Care) Regulations 2006

Child Care Services (Outside School Hours Family Day Care) Regulations 2006

Child Care Services (Rural Family Care) Regulations 2010

ADDITIONS

4. Fences

4.1 Administering Agency

Building Commission, Department of Commerce

Relevant Legislation

Dividing Fences Act 1961

5. Health

5.1 Administering Agency

Department of Health

Relevant Legislation

Health Act 1911

Health Act (Laundries & Bathrooms) Regulations

Health (Air Handling and Water Systems) Regulations 1994

Health (Asbestos) Regulations 1992

Health (Aquatic Facilities) Regulations 2007

Health (Construction Work) Regulations 1973

Construction Camp Regulations

Health (Public Buildings) Regulations 1992

Health (Treatment of Sewage and Disposal of Effluent and Liquid Waste) Regulations 1974

Health (Rottnest Island) By-laws 1989

Sewerage (Lighting, Ventilation and Construction) Regulations 1971

Model By-Laws Series 'A' and earlier versions where adopted by Local Government

Health Local Laws where adopted by Local Government

6. Heritage

6.1 Administering Agency

Heritage Council of Western Australia

Relevant Legislation

Heritage of Western Australia Act 1990

Heritage of Western Australia Regulations 1991

7. Housing

7.1 Administering Agency

Department of Housing

Relevant Legislation

Housing Act 1980

ADDITIONS

8. Land

8.1 Administering Agency

Western Australian Land Information Authority

Relevant Legislation

Strata Titles Act 1985

9. Occupational Health and Safety

9.1 Administering Agency

WorkSafe, Department of Commerce

Relevant Legislation

Occupational Safety and Health Act 1984

10. Planning Controls

10.1 Administering Agency

Department for Planning

Relevant Legislation

Planning and Development Act 2005

Planning and Development (Consequential and Transitional Provisions) Act 2005

11. Public Works

11.1 Administering Agency

Building Management and Works, Department of Treasury and Finance

Relevant Legislation

Public Works Act 1902

INDEX, ABBREVIATIONS AND SYMBOLS

INDEX

Abbreviations and Symbols

INDEX CONTENTS

INDEX, ABBREVIATIONS AND SYMBOLS

Index

Abbreviations and Symbols

INDEX (TO DEEMED-TO-SATISFY PROVISIONS)

A

Air movement (energy efficiency)

[PART-3.12.4.1](#) Air movement

Air-handling systems

[PART-3.8.5.1](#) Application

Airlocks

[PART-3.8.5.3](#) Location of sanitary compartments

Allowable bearing pressure (foundations)

[PART-3.2.2.3](#) Foundations for footings and slabs

Allowable encroachments (fire safety)

[PART-3.7.1.7](#) Allowable encroachments

Alpine areas

[PART-3.7.5.1](#) Application

Aluminium structures

[PART-3.11.6](#) Determination of structural resistance of materials and forms of construction

Articulated masonry

[PART-3.2](#) Definitions

Artificial lighting

[PART-3.8.4.3](#) Artificial lighting

Asphalt shingles

[PART-3.5.1.0](#) Acceptable construction manuals

B

Balcony (barriers)

[PART-3.9.2.1](#) Application

Barriers

[PART-3.9.2.1](#) Application

[PART-3.9.2.5](#) Protection of openable windows

Baths

[PART-3.8.3.1](#) Application

BCA application

[PART-1.0.1](#) Adoption

BCA application (adoption of Standards)

[PART-1.1.2](#) Adoption of referenced documents

Borrowed light

[PART-3.8.4.1](#) Application

Breeze paths

[PART-3.12.4.2](#) Ventilation openings

Building classification

[PART-1.3.1](#) Principles of classification

Building fabric

[PART-3.12.1](#) Application

Building sealing (energy efficiency)

[PART-3.12.3](#) Application

Bulk insulation (energy efficiency)

[PART-3.12.1.1](#) Building fabric insulation

C

Carports (fire safety)

[PART-3.7.1.6](#) Class 10a buildings

Ceiling fans

[PART-3.12.4.3](#) Ceiling fans and evaporative coolers

Ceiling heights

[PART-3.8.2.1](#) Application

Ceiling insulation (energy efficiency)

[PART-3.12.1.2](#) Roofs

Central heating

[PART-3.12.5.2](#) Central heating water piping

Chimney construction

[PART-3.7.3.3](#) Chimney construction

Chimneys and flues (energy efficiency)

[PART-3.12.3.1](#) Chimneys and flues

Clad frame

[PART-3.2](#) Definitions

Class 10a buildings (energy efficiency)

[PART-3.12.1.6](#) Attached Class 10a buildings

Class 10a buildings (fire safety)

[PART-3.7.1.6](#) Class 10a buildings

Climate Zone map

[PART-1.1.1](#) Definitions

Clothes washing facilities

[PART-3.8.3.1](#) Application

Columns (structural steel)

[PART-3.4.4.3](#) Columns

Composite steel and concrete

[PART-3.11.6](#) Determination of structural resistance of materials and forms of construction

Concrete

[PART-3.2.3.1](#) Concrete

Concrete roof tiles

[PART-3.5.1.1](#) Application

Concrete structures

[PART-3.11.6](#) Determination of structural resistance of materials and forms of construction

Conditioned space

[PART-3.12](#) Definitions

Controlled fill

[PART-3.2](#) Definitions

Corrosion protection (metal sheet roofing)

[PART-3.5.1.3](#) Metal sheet roofing

Corrosion protection (steel framing)

[PART-3.4.2.2](#) General

Corrosion protection (steel)

[PART-3.4.4.4](#) Corrosion protection

Cyclonic areas

[PART-3.10.1.0](#) Acceptable construction manuals

D

Damp-proofing (slab on ground)

[PART-3.2.2.1](#) Excavation for footings

Definitions

[PART-1.1.1](#) Definitions

Design suitability

[PART-1.2.2](#) Evidence of suitability

Diagrams (interpretation)

[PART-1.1.7](#) Interpretation of diagrams

Domestic services (energy efficiency)

[PART-3.12.5.1](#) Insulation of services

Doors (energy efficiency)

[PART-3.12.3.3](#) External windows and doors

Doors (glass)

[PART-3.6.4.1](#) Doors

Downpipes

[PART-3.5.2.1](#) Application

Drainage

[PART-3.1.1.0](#) Application

[PART-3.1.2.1](#) Application

Drainage (roofs)

[PART-3.5.2.1](#) Application

Ductwork (fire properties)

[PART-3.7.1.9](#) Fire hazard properties

E

Earthworks

[PART-3.1.1.0](#) Application

[PART-3.1.1.1](#) Earthworks

Eaves and soffit linings

[PART-3.5.3.5](#) Eaves and soffit linings

Edge beams

[PART-3.2.2.4](#) Slab edge support on sloping sites

[PART-3.2.5.4](#) Minimum edge beam dimensions

Edge rebates

[PART-3.2.2.7](#) Edge rebates

Energy efficiency

[PART-3.12.1](#) Application

Energy efficiency (building fabric)

[PART-3.12.1](#) Application

Energy efficiency (building sealing)

[PART-3.12.3](#) Application

Energy efficiency (Class 10a)

PART-3.12.1.6 Attached Class 10a buildings

Evaporative coolers

PART-3.12.3.6 Evaporative coolers

PART-3.12.4.3 Ceiling fans and evaporative coolers

Evaporative coolers (energy efficiency)

PART-3.12.3.6 Evaporative coolers

Evidence of suitability

PART-1.2.2 Evidence of suitability

Excavation

PART-3.1.1.2 Excavation adjacent to vacant adjoining property

PART-3.1.1.3 Excavation adjacent to existing buildings

Excavation (footings)

PART-3.2.2.1 Excavation for footings

Exhaust fans (energy efficiency)

PART-3.12.3.4 Exhaust fans

Exhaust ventilation (closet pans, kitchens)

PART-3.8.5.1 Application

Existing buildings (footings and slabs)

PART-3.2.5.2 Footings and slabs to extensions to existing buildings

Exit (alpine areas)

PART-3.7.5.1 Application

Explanatory information

PART-1.1.8 Explanatory information

External glazing (energy efficiency)

PART-3.12.2 Application

External stairways

PART-3.9.1.1 Application

External wall (fire resistance)

PART-3.7.1.1 Application

External walls (energy efficiency)

PART-3.12.1.4 External walls

External walls (fire safety)

PART-3.7.1.3 External walls of Class 1 buildings

PART-3.7.1.5 Construction of external walls

F

Fibre sheeting

[PART-3.5.1.1](#) Application

Fill

[PART-3.1.1.4](#) Fill

Fill (under slabs)

[PART-3.2.2.2](#) Filling under concrete slabs

Finished ground level

[PART-3.2](#) Definitions

Fire hazard properties

[PART-1.2.4](#) Fire hazard properties

[PART-3.7.1.9](#) Fire hazard properties

Fire resistance (building elements)

[PART-1.2.3](#) Fire resistance of building elements

Fire resisting construction

[PART-3.7.1.1](#) Application

Fire safety

[PART-3.7.1.1](#) Application

[PART-3.7.3.1](#) Application

Fire safety (alpine areas)

[PART-3.7.5.1](#) Application

Fire separation

[PART-3.7.1.1](#) Application

Fireplaces (energy efficiency)

[PART-3.12.3.1](#) Chimneys and flues

Fireplaces (footings)

[PART-3.2.5.1](#) Footing and slab construction

[PART-3.2.5.5](#) Footings for fireplaces on Class A and S sites

Flashings (roofing)

[PART-3.5.1.3](#) Metal sheet roofing

Flashings (wall openings)

[PART-3.5.3.6](#) Flashings to wall openings

Flight

[PART-3.9.1](#) Definitions

Flood hazard areas

[PART-3.10.3.0](#) Acceptable construction manual

Floors (damproofing)

[PART-3.2.2.1](#) Excavation for footings

Floors (energy efficiency)

[PART-3.12.1.5](#) Floors

Floors (sealing for energy efficiency)

[PART-3.12.3.5](#) Construction of roofs, walls and floors

Floors (sub-floor ventilation)

[PART-3.4.1.1](#) Application

Flues, chimneys and fireplaces

[PART-3.7.3.1](#) Application

Footing

[PART-3.2](#) Definitions

Footing and slab construction

[PART-3.2.5.1](#) Footing and slab construction

Footings (stepped)

[PART-3.2.2.5](#) Stepped footings

Footings and slabs

[PART-3.2.1](#) Application

[PART-3.2.2.1](#) Excavation for footings

Foundations (footings and slabs)

[PART-3.2.2.3](#) Foundations for footings and slabs

Framing (steel)

[PART-3.4.2.1](#) Application

Framing (timber)

[PART-3.4.3.0](#) Acceptable construction manuals

G

Glass (human impact)

[PART-3.6.4](#) Human impact safety requirements

Glazing

[PART-3.6.0](#) Acceptable construction manuals

[PART-3.6.1](#) Application

Glazing area limits (energy efficiency)

[PART-3.12.2.1](#) External glazing

Going

[PART-3.9.1](#) Definitions

GRP sheeting

[PART-3.5.1.1](#) Application

Gutters and downpipes

[PART-3.5.2.1](#) Application

H

Habitable room (ceiling heights)

[PART-3.8.2.1](#) Application

Habitable room (natural light)

[PART-3.8.4.1](#) Application

Habitable room (sound insulation)

[PART-3.8.6.1](#) Application

Hearths

[PART-3.7.3.1](#) Application

Heated floor slabs

[PART-3.12.1.5](#) Floors

Heated water supply systems

[PART-3.12.5.0](#) Acceptable construction manuals

Heating and cooling ductwork

[PART-3.12.5.3](#) Heating and cooling ductwork

Heating appliances

[PART-3.7.3.5](#) Installation of free standing heating appliances

Heating appliances (energy efficiency)

[PART-3.12.3.1](#) Chimneys and flues

Heating appliances (fire safety)

[PART-3.7.3.1](#) Application

High wind areas

[PART-3.10.1.0](#) Acceptable construction manuals

High wind areas Cyclonic areas

[PART-3.10.1.0](#) Acceptable construction manuals

Human impact (glass)

[PART-3.6.4](#) Human impact safety requirements

I

Impact sound

[PART-3.8.6.1](#) Application

Imposed actions (structural)

[PART-3.11.1](#) Application

Insulation (ductwork)

[PART-3.12.5.3](#) Heating and cooling ductwork

Insulation (energy efficiency)

[PART-3.12.1.1](#) Building fabric insulation

Insulation (services, energy efficiency)

[PART-3.12.5.1](#) Insulation of services

Interpretation of diagrams

[PART-1.1.7](#) Interpretation of diagrams

K

Kitchen exhaust

[PART-3.8.5.1](#) Application

Kitchen facilities

[PART-3.8.3.1](#) Application

L

Ladders

[PART-3.9.1.1](#) Application

Landing

[PART-3.9.1](#) Definitions

Landings

[PART-3.9.1.1](#) Application

[PART-3.9.2.1](#) Application

Language

[PART-1.1.6](#) Language

Laundry (waterproofing)

[PART-3.8.1](#) Definitions

Light

[PART-3.8.4.1](#) Application

Light (artificial)

[PART-3.8.4.3](#) Artificial lighting

Light (natural)

[PART-3.8.4.2](#) Natural lighting

Lintels

[PART-3.4.4.1](#) Application

Loadbearing wall

[PART-3.2](#) Definitions

Loads (structural)

[PART-3.11.1](#) Application

M

Masonry (weatherproofing)

[PART-3.3.4.0](#) Acceptable construction manual

Masonry accessories

[PART-3.3.3.0](#) Acceptable construction manual

Materials (non-combustible)

[PART-3.7.1.2](#) General concession—non-combustible materials

Materials (suitability)

[PART-1.2.1](#) Suitability of materials

Metal sheet roofing

[PART-3.5.1.3](#) Metal sheet roofing

Mixed construction

[PART-3.2](#) Definitions

Moisture barriers

[PART-3.2.2.6](#) Vapour barriers

Multiple classifications

[PART-1.3.3](#) Multiple classifications

N

Natural light

[PART-3.8.4.2](#) Natural lighting

Natural ventilation

[PART-3.8.5.2](#) Ventilation requirements

Non-combustible materials

[PART-3.7.1.2](#) General concession—non-combustible materials

O

Open fireplace construction

[PART-3.7.3.2](#) Open fireplace construction

Openings in external walls

[PART-3.7.1.3](#) External walls of Class 1 buildings

Orientation factor (glazing)

[PART-3.12.2.1](#) External glazing

P

Perimeter of building

[PART-3.6](#) Definitions

Piled footing

[PART-3.2.1](#) Application

Pipe insulation (central heating)

[PART-3.12.5.2](#) Central heating water piping

Pipes (sound insulation)

[PART-3.8.6.4](#) Services

Piping

[PART-3.12](#) Definitions

Primary building element

[PART-3.1](#) Definitions

Principles of classification

[PART-1.3.1](#) Principles of classification

Protection of openings

[PART-3.7.1.1](#) Application

PVC sheeting

[PART-3.5.1.1](#) Application

R

R-Value

[PART-3.12](#) Definitions

Rainwater tanks

[PART-3.7.1.7](#) Allowable encroachments

Referenced documents

[PART-1.4.1](#) Schedule of referenced documents

Reflective insulation

PART-3.12 Definitions

PART-3.12.1.1 Building fabric insulation

Reinforced masonry

PART-3.3.2.0 Acceptable construction manual

Reinforcing (concrete)

PART-3.2.3.1 Concrete

Riser

PART-3.9.1 Definitions

Risers and goings

PART-3.9.1.4 Riser and going dimensions

Rolled fill

PART-3.2 Definitions

Roof cladding

PART-3.5.1.1 Application

Roof insulation

PART-3.12.1.2 Roofs

Roof lights (energy efficiency)

PART-3.12.1.3 Roof lights

PART-3.12.3.2 Roof lights

Roof lights (fire safety)

PART-3.7.1.10 Roof lights

Roof lights (natural light)

PART-3.8.4.2 Natural lighting

Roof tiling

PART-3.5.1.2 Roof tiling

Roof ventilation (energy efficiency)

PART-3.12.1.2 Roofs

Roofs (sealing for energy efficiency)

PART-3.12.3.5 Construction of roofs, walls and floors

Room heights

PART-3.8.2.1 Application

S

Sanitary compartment (waterproofing)

PART-3.8.1 Definitions

Sanitary compartments

[PART-3.8.3.3](#) Construction of sanitary compartments

Sanitary compartments (location and ventilation)

[PART-3.8.5.3](#) Location of sanitary compartments

Sanitary facilities

[PART-3.8.3.1](#) Application

Sarking-type materials

[PART-3.7.1.9](#) Fire hazard properties

Separating walls

[PART-3.7.1.8](#) Separating walls

Services (energy efficiency)

[PART-3.12.5.1](#) Insulation of services

Services (sound insulation)

[PART-3.8.6.4](#) Services

Services (steel framing)

[PART-3.4.2.6](#) Installation of services

Shading (energy efficiency)

[PART-3.12.2.2](#) Shading

Sheet wall cladding

[PART-3.5.3.4](#) Sheet wall cladding

Shower enclosure

[PART-3.8.1](#) Definitions

Shower screens

[PART-3.6.4.5](#) Bathroom, ensuite and spa room glazing

Showers

[PART-3.8.3.1](#) Application

Shrinkage control

[PART-3.2.5.3](#) Shrinkage control

Single leaf masonry

[PART-3.2](#) Definitions

Site classification

[PART-3.2.4.1](#) Site classification

Siteworks

[PART-3.1.1.0](#) Application

Siteworks (drainage)

[PART-3.1.2.1](#) Application

Slab (edge insulation)

[PART-3.12.1.5](#) Floors

Slab edge support

[PART-3.2.2.4](#) Slab edge support on sloping sites

Slabs

[PART-3.2.5.1](#) Footing and slab construction

Smoke alarms

[PART-3.7.2.1](#) Application

Snow areas (fire safety)

[PART-3.7.5.1](#) Application

Snow loads

[PART-3.11.1](#) Application

Software

[PART-3.4.0.2](#) Structural Software

Sound insulation

[PART-3.8.6.1](#) Application

Spiral stair

[PART-3.9.1](#) Definitions

Stair construction

[PART-3.9.1.1](#) Application

Stairway (barriers)

[PART-3.9.2.1](#) Application

Standards

[PART-1.1.2](#) Adoption of referenced documents

[PART-1.4.1](#) Schedule of referenced documents

Steel (corrosion protection)

[PART-3.4.4.4](#) Corrosion protection

Steel (structural members)

[PART-3.4.4.1](#) Application

Steel columns

[PART-3.4.4.3](#) Columns

Steel floor framing

[PART-3.4.2.3](#) Steel floor framing

Steel framing

[PART-3.4.2.1](#) Application

Steel framing (corrosion protection)

[PART-3.4.2.2](#) General

Steel reinforcement

[PART-3.2.3.2](#) Steel reinforcement

Stepped footings

[PART-3.2.2.5](#) Stepped footings

Stormwater drainage

[PART-3.1.2.1](#) Application

[PART-3.5.2.1](#) Application

Structural (earthquake areas)

[PART-3.11.1](#) Application

Structural Software

[PART-3.4.0.2](#) Structural Software

Structural steel members

[PART-3.4.4.1](#) Application

Stump footings

[PART-3.2.5.6](#) Stump footing details

Sub-floor ventilation

[PART-3.4.1.1](#) Application

Suitability of materials

[PART-1.2.1](#) Suitability of materials

T

Tapered tread

[PART-3.9.1](#) Definitions

Termite barriers

[PART-3.1.3.2](#) Installation of termite management systems

Termite barriers (slab-on-ground)

[PART-3.1.3.3](#) Concrete slab-on-ground edge exposure

Termite barriers (suspended floor)

[PART-3.1.3.4](#) Sheet materials

Termites

[PART-3.1-3.1.3](#) Application

Terracotta roof tiles

[PART-3.5.1.1](#) Application

Thresholds

[PART-3.9.1.5](#) Threshold

Timber framing

[PART-3.4.3.0](#) Acceptable construction manuals

Timber wall cladding

[PART-3.5.3.2](#) Timber weatherboard cladding

Total R-Value

[PART-3.12](#) Definitions

Total U-Value

[PART-3.12](#) Definitions

Treads

[PART-3.9.1.4](#) Riser and going dimensions

U

Unobstructed opening

[PART-3.6](#) Definitions

Unreinforced masonry

[PART-3.3.1.0](#) Acceptable construction manual

V

Vapour barriers

[PART-3.2.2.1](#) Excavation for footings

[PART-3.2.2.6](#) Vapour barriers

Ventilation

[PART-3.8.5.1](#) Application

Ventilation (sub-floor)

[PART-3.4.1.1](#) Application

Ventilation opening

[PART-3.12](#) Definitions

Ventilation openings

[PART-3.12.4.2](#) Ventilation openings

Verification method

[V2.6.1](#) Application of this Part

[V2.6.2.1](#) *****

[V2.6.2.2](#) Verification using a reference building

Visibility of glazing

[PART-3.6.4.6](#) Visibility of glazing

W

Waffle raft

[PART-3.2](#) Definitions

Wall cladding

[PART-3.5.3.0](#) Acceptable construction manual

[PART-3.5.3.1](#) Application

[PART-3.5.3.3](#) Wall cladding boards

Walls (sealing for energy efficiency)

[PART-3.12.3.5](#) Construction of roofs, walls and floors

Washbasins

[PART-3.8.3.1](#) Application

Water resistant

[PART-3.8.1](#) Definitions

Waterproof

[PART-3.8.1](#) Definitions

Waterproofing

[PART-3.8.1](#) Definitions

Weatherproofing (masonry)

[PART-3.3.4.0](#) Acceptable construction manual

Weighted sound reduction index

[PART-3.8.6.1](#) Application

Wet area

[PART-3.8.1](#) Definitions

Winders

[PART-3.9.1](#) Definitions

Windows (energy efficiency)

[PART-3.12.3.3](#) External windows and doors

Windows (natural light)

[PART-3.8.4.2](#) Natural lighting

ABBREVIATIONS AND SYMBOLS

Abbreviations and Symbols used in the *Housing Provisions* include:

ABBREVIATIONS

ABCB	Australian Building Codes Board
AISC	Australian Institute of Steel Construction
ALGA	Australian Local Government Association
AS	Australian Standard
ASTM	American Society for Testing and Materials
BCA	Building Code of Australia
BCC	Building Codes Committee
CSIRO	Commonwealth Scientific and Industrial Research Organisation
FRL	Fire Resistance Level
GRP	Glass fibre reinforced polyester
ISO	International Organisation for Standardisation
Low-e	Low emissivity
NATA	National Association of Testing Authorities
Pa	Pascal
PVC	Polyvinyl chloride
R_w	Weighted Sound Reduction Index
R-Value	Thermal resistance coefficient
SHGC	Solar heat gain coefficient
STC	Sound Transmission Class
UPVC	Unplasticised polyvinyl chloride
U-Value	Thermal transmittance

SYMBOLS AND SI UNITS

$^{\circ}\text{C}$	degree(s) Celsius
-e/MJ	equivalent per megajoule(s)
g/m ²	gram(s) per square metre
K	kelvin(s)
kg	kilogram(s)
kg/m	kilogram(s) per metre
kg/m ²	kilogram(s) per square metre
kg/m ³	kilogram(s) per cubic metre

INDEX, ABBREVIATIONS AND SYMBOLS

km	kilometre
kPa	kilopascal(s)
kW/m ²	kilowatt(s) per square metre
L	litre(s)
L/s	litre(s) per second
L/s.m ²	litre(s) per second square metre
lx	lux
dia.	diameter
F	in relation to steel members means steel fabric
m	metre(s)
m ²	square metre(s)
m ³	cubic metre(s)
m/s	metre(s) per second
m ³ /s	cubic metre(s) per second
mm	millimetre(s)
mm ²	square millimetre(s)
µm	micrometre
µm/y	micrometre(s) per year
MJ/hour	megajoule(s) per hour
MJ/m ² .annum	megajoule(s) per square metre per annum
MW	megawatt(s)
N	newton(s)
Pa	pascal(s)
MPa	megapascal(s)
W	Watt(s)
°south	degree south
%	percent
>	greater than
<	less than
≤	equal to or less than
≥	equal to or more than

HISTORY OF AMENDMENTS

CONTENTS

HISTORY OF AMENDMENTS

History of amendments

- 1.0 Adoption of BCA96
- 1.1 Amendment No. 1
- 1.2 Amendment No. 2
- 1.3 Amendment No. 3
- 1.4 Amendment No. 4
- 1.5 Amendment No. 5
- 1.6 Amendment No. 6
- 1.7 Amendment No. 7
- 1.8 Amendment No. 8
- 1.9 Amendment No. 9
- 1.10 Amendment No. 10
- 1.11 Amendment No. 11
- 1.12 Amendment No. 12
- 1.13 Amendment No. 13
- 2.0 Adoption of BCA 2004
- 3.0 Adoption of BCA 2005
- 4.0 Adoption of BCA 2006
- 5.0 Adoption of BCA 2007
- 6.0 Adoption of BCA 2008
- 7.0 Adoption of BCA 2009
- 8.0 Adoption of BCA 2010
- 9.0 Adoption of BCA 2011
- 10.0 Adoption of BCA 2012
- 11.0 Adoption of BCA 2013
- 12.0 Adoption of BCA 2014
- 13.0 Adoption of BCA 2015

HISTORY OF BCA ADOPTION

1.0 Adoption of BCA96

The 1996 edition of the BCA was adopted by the Commonwealth, States and Territories as set out in Table 1.0.

Table 1.0 History of adoption of BCA96

Administration	Adoption Date
Australian Government	1 July 1997
Australian Capital Territory	1 July 1997
New South Wales	1 July 1997
Northern Territory	7 January 1998
Queensland	1 July 1997
South Australia	1 January 1998
Tasmania	1 July 1997
Victoria	1 August 1997
Western Australia	1 July 1997

1.1 Amendment No. 1

- (a) Amendment No. 1 of the 1996 edition of the BCA was adopted by the Commonwealth, States and Territories as set out in Table 1.1.

Table 1.1 History of adoption of Amendment No. 1 of BCA96

Administration	Adoption Date
Australian Government	1 July 1997
Australian Capital Territory	1 July 1997
New South Wales	1 July 1997
Northern Territory	7 January 1998
Queensland	1 July 1997
South Australia	1 January 1998
Tasmania	1 July 1997
Victoria	1 August 1997
Western Australia	1 July 1997

- (b) The purpose of Amendment No. 1 is to—
- (i) include typographical changes including spelling, punctuation, cross references and layout; and
 - (ii) include reference to a *Certificate of Conformity* issued by the ABCB in A2.2; and

HISTORY OF AMENDMENTS

- (iii) change the reference to the Standards Mark Certificate to refer to JAS–ANZ in A2.2; and
- (iv) update references to Standards.

Note:

The revisions contained in Amendment No. 1 to the *Housing Provisions* have not been marked in the text.

1.2 Amendment No. 2

- (a) Amendment No. 2 of the 1996 edition of the BCA was adopted by the Commonwealth, States and Territories as set out in Table 1.2.

Table 1.2 History of adoption of Amendment No. 2 of BCA96

Administration	Adoption Date
Australian Government	1 January 1998
Australian Capital Territory	1 January 1998
New South Wales	27 February 1998
Northern Territory	7 January 1998
Queensland	1 January 1998
South Australia	1 January 1998
Tasmania	1 January 1998
Victoria	1 January 1998
Western Australia	1 January 1998

- (b) The purpose of Amendment No. 2 is to—
 - (i) include typographical changes including spelling, punctuation, cross references and layout; and
 - (ii) update references to Standards; and
 - (iii) include minor technical changes.

1.3 Amendment No. 3

- (a) Amendment No. 3 of the 1996 edition of the BCA was adopted by the Commonwealth, States and Territories as set out in Table 1.3.

Table 1.3 History of adoption of Amendment No. 3 of BCA96

Administration	Adoption Date
Australian Government	1 July 1998
Australian Capital Territory	1 July 1998
New South Wales	1 July 1998
Northern Territory	1 July 1998
Queensland	1 July 1998

HISTORY OF AMENDMENTS

Table 1.3 History of adoption of Amendment No. 3 of BCA96 — continued

Administration	Adoption Date
South Australia	13 July 1998
Tasmania	1 July 1998
Victoria	1 July 1998
Western Australia	1 July 1998

- (b) The purpose of Amendment No. 3 is to—
- (i) incorporate the outcomes of the 1997 ABCB Variations Conference; and
 - (ii) update references to Standards; and
 - (iii) include minor technical changes.

1.4 Amendment No. 4

- (a) Amendment No. 4 of the 1996 edition of the BCA was adopted as set out in Table 1.4.

Table 1.4 History of adoption of Amendment No. 4 of BCA96

Administration	Adoption Date
Australian Government	1 January 1999
Australian Capital Territory	17 May 1999
New South Wales	1 February 1999
Northern Territory	1 January 1999
Queensland	1 January 1999
South Australia	1 January 1999
Tasmania	1 January 1999
Victoria	1 January 1999
Western Australia	1 January 1999

- (b) The purpose of Amendment No. 4 is to—
- (i) update references to Standards; and
 - (ii) include minor technical changes.

1.5 Amendment No. 5

- (a) Amendment No. 5 of the 1996 edition of the BCA was adopted by the Commonwealth, States and Territories as set out in Table 1.5.

Table 1.5 History of adoption of Amendment No. 5 of BCA96

Administration	Adoption Date
Australian Government	1 July 1999
Australian Capital Territory	3 November 1999
New South Wales	1 August 1999

HISTORY OF AMENDMENTS

Table 1.5 History of adoption of Amendment No. 5 of BCA96 — continued

Administration	Adoption Date
Northern Territory	1 July 1999
Queensland	1 July 1999
South Australia	1 July 1999
Tasmania	1 July 1999
Victoria	1 July 1999
Western Australia	1 July 1999

- (b) The purpose of Amendment No. 5 is to—
- (i) update references to Standards; and
 - (ii) expand on the requirements for sub-floor ventilation based on climatic conditions; and
 - (iii) revise the Acceptable Construction Practice for Steel framing; and
 - (iv) include additional details in the Acceptable Construction Practice for fencing of swimming pools; and
 - (v) include minor technical changes.

1.6 Amendment No. 6

- (a) Amendment No. 6 of the 1996 edition of the BCA was adopted by the Commonwealth, States and Territories as set out in Table 1.6.

Table 1.6 History of adoption of Amendment No. 6 of BCA96

Administration	Adoption Date
Australian Government	1 January 2000
Australian Capital Territory	10 February 2000
New South Wales	1 January 2000
Northern Territory	1 January 2000
Queensland	1 January 2000
South Australia	17 January 2000
Tasmania	1 January 2000
Victoria	1 January 2000
Western Australia	1 January 2000

- (b) The purpose of Amendment No. 6 is to—
- (i) update references to Standards; and
 - (ii) revise the Acceptable Construction Practice for Footing and Slab Construction; and
 - (iii) replace Sound Transmission Class (STC) with weighted sound reduction index (R_w) within Part 3.8.6; and
 - (iv) include minor technical changes.

HISTORY OF AMENDMENTS

1.7 Amendment No. 7

- (a) Amendment No. 7 of the 1996 edition of the BCA was adopted by the Commonwealth, States and Territories as set out in Table 1.7.

Table 1.7 History of adoption of Amendment No. 7 of BCA96

Administration	Adoption Date
Australian Government	1 July 2000
Australian Capital Territory	10 July 2000
New South Wales	1 July 2000
Northern Territory	1 July 2000
Queensland	1 July 2000
South Australia	1 July 2000
Tasmania	1 July 2000
Victoria	1 July 2000
Western Australia	1 July 2000

- (b) The purpose of Amendment No. 7 is to—
- (i) update references to Standards; and
 - (ii) include requirements for separation of eaves and verandah spaces that are open to the roof space and common to 2 or more Class 1 buildings; and
 - (iii) reinstate the Acceptable Construction Practice for buildings in bushfire-prone areas, following alignment with the 1999 version of AS 3959; and
 - (iv) change the limitations on winders used in lieu of quarter and half landings within stairways; and
 - (v) include minor technical changes.

1.8 Amendment No. 8

- (a) Amendment No. 8 of the 1996 edition of the BCA was adopted by the Commonwealth, States and Territories as set out in Table 1.8.

Table 1.8 History of adoption of Amendment No. 8 of BCA96

Administration	Adoption Date
Australian Government	1 January 2001
Australian Capital Territory	11 January 2001
New South Wales	1 January 2001
Northern Territory	1 January 2001
Queensland	1 January 2001
South Australia	1 January 2001
Tasmania	1 January 2001

HISTORY OF AMENDMENTS

Table 1.8 History of adoption of Amendment No. 8 of BCA96 — continued

Administration	Adoption Date
Victoria	1 January 2001
Western Australia	1 January 2001

- (b) The purpose of Amendment No. 8 is to—
- (i) update references to Standards; and
 - (ii) include minor technical changes; and
 - (iii) achieve greater consistency between both Volumes of the BCA for stair construction.

1.9 Amendment No. 9

- (a) Amendment No. 9 of the 1996 edition of the BCA was adopted by the Commonwealth, States and Territories as set out in Table 1.9.

Table 1.9 History of adoption of Amendment No. 9 of BCA96

Administration	Adoption Date
Australian Government	1 July 2001
Australian Capital Territory	12 July 2001
New South Wales	1 July 2001
Northern Territory	1 July 2001
Queensland	1 July 2001
South Australia	2 July 2001
Tasmania	1 July 2001
Victoria	1 July 2001
Western Australia	1 July 2001

- (b) The purpose of Amendment No. 9 is to—
- (i) update references to Standards; and
 - (ii) include minor technical changes; and
 - (iii) clarify which glazing assemblies must comply with AS 2047 and which must comply with AS 1288.

1.10 Amendment No. 10

- (a) Amendment No. 10 of the 1996 edition of the BCA was adopted by the Commonwealth, States and Territories as set out in Table 1.10.

Table 1.10 History of adoption of Amendment No. 10 of BCA96

Administration	Adoption Date
Australian Government	1 January 2002
Australian Capital Territory	1 January 2002

HISTORY OF AMENDMENTS

Table 1.10 History of adoption of Amendment No. 10 of BCA96 — continued

Administration	Adoption Date
New South Wales	1 January 2002
Northern Territory	1 January 2002
Queensland	1 January 2002
South Australia	1 January 2002 (except SA2—date to be advised)
Tasmania	1 January 2002
Victoria	1 January 2002
Western Australia	1 January 2002

- (b) The purpose of Amendment No. 10 is to—
- (i) update references to Standards; and
 - (ii) update the requirements for protective coatings for steelwork in locations near saltwater; and
 - (iii) align [Figure 3.6.1](#) dealing with glazing with AS 1288; and
 - (iv) extend the concession for fire separation of windows in non-habitable rooms to windows in bathrooms, laundries and toilets and also include buildings on the same allotment; and
 - (v) replace testing to AS/NZS 1530.3 for timber in bushfire areas with reference to AS/NZS 3837; and
 - (vi) include minor technical changes.

1.11 Amendment No. 11

- (a) Amendment No. 11 of the 1996 edition of the BCA was adopted by the Commonwealth, States and Territories as set out in Table 1.11.

Table 1.11 History of adoption of Amendment No. 11 of BCA96

Administration	Adoption Date
Australian Government	1 July 2002
Australian Capital Territory	1 July 2002 (except Australian Capital Territory additions—which was adopted on 21 June 2002)
New South Wales	1 July 2002
Northern Territory	1 July 2002
Queensland	1 July 2002
South Australia	1 July 2002
Tasmania	1 July 2002
Victoria	1 July 2002
Western Australia	1 July 2002

HISTORY OF AMENDMENTS

- (b) The purpose of Amendment No. 11 is to—
- (i) update references to Standards; and
 - (ii) transfer public policy matters, with respect to structural adequacy, from the AS 1170 series to the BCA; and
 - (iii) introduce new definitions and more detailed provisions on the installation of *flashings* and *damp-proof courses*; and
 - (iv) include minor technical changes.

1.12 Amendment No. 12

- (a) Amendment No. 12 of the 1996 edition of the BCA was adopted by the Commonwealth, States and Territories as set out in Table 1.12.

Table 1.12 History of adoption of Amendment No. 12 of BCA96

Administration	Adoption Date
Australian Government	1 January 2003
Australian Capital Territory	1 January 2003
New South Wales	1 January 2003
Northern Territory	1 January 2003
Queensland	1 January 2003
South Australia	1 January 2003
Tasmania	1 January 2003
Victoria	1 January 2003
Western Australia	1 January 2003

- (b) The purpose of Amendment No. 12 is to—
- (i) update references to Standards; and
 - (ii) allow the use of either the 1989 editions or the 2002 editions of the 1170 series of standards; and
 - (iii) include Energy Efficiency measures into the *Housing Provisions*; and
 - (iv) include minor technical changes.

Note:

Only substantive typographical corrections are noted in the margin.

1.13 Amendment No. 13

- (a) Amendment No. 13 of the 1996 edition of the BCA was adopted by the Commonwealth, States and Territories as set out in Table 1.13.

Table 1.13 History of adoption of Amendment No. 13 of BCA96

Administration	Adoption Date
Australian Government	1 July 2003

HISTORY OF AMENDMENTS

Table 1.13 History of adoption of Amendment No. 13 of BCA96 — continued

Administration	Adoption Date
Australian Capital Territory	1 July 2003
New South Wales	1 July 2003
Northern Territory	1 July 2003
Queensland	1 July 2003 (except for Parts 2.6 and 3.12 which are adopted on 1 September 2003)
South Australia	1 July 2003
Tasmania	1 July 2003
Victoria	1 July 2003
Western Australia	1 July 2003

- (b) The purpose of Amendment No. 13 is to—
- (i) update references to Standards; and
 - (ii) refine the Energy Efficiency provisions and advise of their adoption in Western Australia and Queensland; and
 - (iii) include minor technical changes.

Note:

Only substantive typographical corrections are noted in the margin.

2.0 Adoption of BCA 2004

(a)

The 2004 edition of the BCA was adopted by the Commonwealth, States and Territories as set out in Table 2.0.

Table 2.0 History of adoption of BCA 2004

Administration	Adoption Date
Australian Government	1 May 2004
Australian Capital Territory	1 May 2004
New South Wales	1 May 2004
Northern Territory	1 May 2004
Queensland	1 May 2004
South Australia	1 May 2004
Tasmania	1 May 2004
Victoria	1 May 2004
Western Australia	1 May 2004

- (b) The purpose of BCA 2004 is to—
- (i) remove references to BCA 96; and

HISTORY OF AMENDMENTS

- (ii) clarify the method of determining the Performance Requirements that are relevant to Alternative Solutions; and
- (iii) update references to other documents; and
- (iv) revise the acceptable construction practice for footing and slab construction; and
- (v) prohibit the use of lead on roofs used to collect potable water; and
- (vi) reform the provisions for sound insulation; and
- (vii) update the Energy Efficiency provisions; and
- (viii) include minor technical changes.

3.0 Adoption of BCA 2005

- (a) The 2005 edition of the BCA was adopted by the Commonwealth, States and Territories as set out in Table 3.0.

Table 3.0 History of adoption of BCA 2005

Administration	Adoption Date
Australian Government	1 May 2005
Australian Capital Territory	1 May 2005
New South Wales	1 May 2005
Northern Territory	1 May 2005
Queensland	1 May 2005
South Australia	1 May 2005
Tasmania	1 May 2005
Victoria	1 May 2005
Western Australia	1 May 2005

- (b) The purpose of BCA 2005 is to—
- (i) update references to other documents; and
 - (ii) update the provisions for waterproofing of wet areas; and
 - (iii) update balustrading provisions to include wire balustrades; and
 - (iv) include minor technical changes.

4.0 Adoption of BCA 2006

- (a) The 2006 edition of the BCA was adopted by the Commonwealth, States and Territories as set out in Table 4.0.

Table 4.0 History of adoption of BCA 2006

Administration	Adoption Date
Australian Government	1 May 2006
Australian Capital Territory	1 May 2006
New South Wales	1 May 2006

HISTORY OF AMENDMENTS

Table 4.0 History of adoption of BCA 2006 — continued

Administration	Adoption Date
Northern Territory	1 May 2006
Queensland	1 May 2006
South Australia	1 May 2006, except for South Australian variations P2.6.2, V2.6.2.3 and 3.12.5.4 and South Australian addition SA2 which were adopted on 1 July 2006. The adoption of South Australian variation clause 3.7.4.2 is yet to be advised.
Tasmania	1 May 2006
Victoria	1 May 2006
Western Australia	1 May 2006

- (b) The purpose of BCA 2006 is to—
- (i) update references to other documents; and
 - (ii) convert the W wind speed categories to the N and C wind speed categories; and
 - (iii) include a national testing regime for cladding in cyclonic areas; and
 - (iv) include enhanced energy efficiency provisions; and
 - (v) include minor technical changes.

5.0 Adoption of BCA 2007

- (a) The 2007 edition of the BCA was adopted by the Commonwealth, States and Territories as set out in Table 5.0.

Table 5.0 History of adoption of BCA 2007

Administration	Adoption Date
Australian Government	1 May 2007
Australian Capital Territory	1 May 2007
New South Wales	1 May 2007
Northern Territory	1 May 2007
Queensland	1 May 2007
South Australia	1 May 2007, excluding South Australian variation clause 3.7.4.2, (for the purposes of sub-clauses (1) and (2) of Schedule 18 of the Development Regulations 1993): and sub-clause c) of variation clause 3.7.4.2 (for the purpose of sub-clauses (3) and (4) of Schedule 18 of the Development Regulations 1993).
Tasmania	1 May 2007
Victoria	1 May 2007

HISTORY OF AMENDMENTS

Table 5.0 History of adoption of BCA 2007 — continued

Administration	Adoption Date
Western Australia	1 May 2007

- (b) The purpose of BCA 2007 is to—
- (i) update references to other documents; and
 - (ii) clarify that compliance with either the appropriate acceptable construction manuals or the appropriate acceptable construction practice set out in Section 3 is deemed to comply with the *Performance Requirements*; and
 - (iii) clarify when it is appropriate to use the acceptable construction practice for the installation of glazing and when it is necessary for windows to comply with AS 2047; and
 - (iv) update acceptable construction practice for the installation of glazing to align with recent changes to AS 1288; and
 - (v) update Energy Efficiency provisions including providing clarification and additional information; and
 - (vi) include minor technical changes.

6.0 Adoption of BCA 2008

- (a) The 2008 edition of the BCA was adopted by the Commonwealth, States and Territories as set out in Table 6.0.

Table 6.0 History of adoption of BCA 2008

Administration	Adoption Date
Australian Government	1 May 2008
Australian Capital Territory	1 May 2008
New South Wales	1 May 2008
Northern Territory	1 May 2008
Queensland	1 May 2008
South Australia	1 May 2008
Tasmania	1 May 2008
Victoria	1 May 2008
Western Australia	1 May 2008

- (b) The purpose of BCA 2008 is to—
- (i) update references to other documents; and
 - (ii) include lists of other legislation affecting buildings in the various States and Territories; and
 - (iii) include provisions for swimming pool water recirculation systems; and
 - (iv) include minor technical changes.

HISTORY OF AMENDMENTS

7.0 Adoption of BCA 2009

- (a) The 2009 edition of the BCA was adopted by the Commonwealth, States and Territories as set out in Table 7.0.

Table 7.0 History of adoption of BCA 2009

Administration	Adoption Date
Australian Government	1 May 2009
Australian Capital Territory	1 May 2009
New South Wales	1 May 2009
Northern Territory	1 May 2009
Queensland	1 May 2009
South Australia	1 May 2009
Tasmania	1 May 2009
Victoria	1 May 2009
Western Australia	1 May 2009

- (b) The purpose of BCA 2009 is to—
- (i) update references to other documents; and
 - (ii) after expiry of the agreed transition period, except for the 1993 edition of AS 1170.4, delete all references to the older loading standards contained in the AS 1170 series and consequently, all provisions referring to them; and
 - (iii) simplify the wire balustrade provisions including the addition of a *Verification Method*; and
 - (iv) clarify the height of rooms in an attic and with a sloping ceiling; and
 - (v) clarify the provisions for the construction of *sanitary compartments* to enable an unconscious occupant to be removed; and
 - (vi) further update the energy efficiency provisions; and
 - (vii) include minor technical changes.

8.0 Adoption of BCA 2010

- (a) The 2010 edition of the BCA was adopted by the Commonwealth, States and Territories as set out in Table 8.0.

Table 8.0 History of adoption of BCA 2010

Administration	Adoption Date
Australian Government	1 May 2010
Australian Capital Territory	1 May 2010
New South Wales	1 May 2010
Northern Territory	1 May 2010
Queensland	1 May 2010

HISTORY OF AMENDMENTS

Table 8.0 History of adoption of BCA 2010 — continued

Administration	Adoption Date
South Australia	1 May 2010 except for Parts 2.6 and 3.12, which were adopted on 1 September 2010, and the restriction on child resistant door sets in 3.9.3.0 and the additional bushfire requirements for 'excluded areas' prescribed in SA 3.7.4.2(d) and (e), which were adopted on 2 December 2010.
Tasmania	1 May 2010
Victoria	1 May 2010
Western Australia	1 May 2010

- (b) The purpose of BCA 2010 is to—
- (i) update references to other documents; and
 - (ii) delete reference to the 1993 edition of AS 1170.4 and consequently all provisions referring to it; and
 - (iii) increase the stringency of the energy efficiency provisions and, as part of reducing greenhouse gas emissions, introduce provisions for lighting and the greenhouse gas intensity of the energy source for services such as water and space heaters; and
 - (iv) update **Part 3.7.4**, as a consequence of referencing the 2009 edition of AS 3959 Construction of buildings in bushfire-prone areas, including—
 - (A) applying the provisions to a Class 10a building or deck associated with a Class 1 building; and
 - (B) the deletion of the acceptable construction practice; and
 - (v) include minor technical changes.

9.0 Adoption of BCA 2011

- (a) The 2011 edition of the BCA was adopted by the Commonwealth, States and Territories as set out in **Table 9.0**.

Table 9.0 History of adoption of BCA 2011

Administration	Adoption Date
Australian Government	1 May 2011
Australian Capital Territory	1 May 2011
New South Wales	1 May 2011
Northern Territory	1 May 2011
Queensland	1 May 2011
South Australia	1 May 2011
Tasmania	1 May 2011
Victoria	1 May 2011

HISTORY OF AMENDMENTS

Table 9.0 History of adoption of BCA 2011 — continued

Administration	Adoption Date
Western Australia	1 May 2011

- (b) The purpose of BCA 2011 is to—
- (i) update references to other documents; and
 - (ii) include provisions for *private bushfire shelters* for Class 1 dwellings; and
 - (iii) revise the definition of Class 1b buildings; and
 - (iv) include minor technical changes.

10.0 Adoption of BCA 2012

- (a) The 2012 edition of the BCA was adopted by the Commonwealth, States and Territories as set out in [Table 10.0](#).

Table 10.0 History of adoption of BCA 2012

Administration	Adoption Date
Australian Government	1 May 2012
Australian Capital Territory	1 May 2012
New South Wales	1 May 2012
Northern Territory	1 May 2012
Queensland	1 May 2012
South Australia	1 May 2012
Tasmania	1 May 2012
Victoria	1 May 2012
Western Australia	1 May 2012

- (b) The purpose of BCA 2012 is to—
- (i) update references to other documents; and
 - (ii) include revised provisions aimed at reducing slips, trips and falls in buildings; and
 - (iii) remove the acceptable construction practice for masonry following the referencing of AS 4773 Masonry for small buildings, and completion of a 12 month transition period; and
 - (iv) restructure the acceptable construction practice for wet areas; and
 - (v) include minor technical changes.

11.0 Adoption of BCA 2013

- (a) The 2013 edition of the BCA was adopted by the Commonwealth, States and Territories as set out in [Table 11.0](#).

HISTORY OF AMENDMENTS

Table 11.0 History of adoption of BCA 2013

Administration	Adoption Date
Australian Government	1 May 2013
Australian Capital Territory	1 May 2013
New South Wales	1 May 2013
Northern Territory	1 May 2013
Queensland	1 May 2013
South Australia	1 May 2013
Tasmania	1 May 2013
Victoria	1 May 2013
Western Australia	1 May 2013

- (b) The purpose of BCA 2013 is to—
- (i) update references to other documents; and
 - (ii) include new provisions for openable windows to reduce falls in buildings; and
 - (iii) include a Performance Requirement and reference a Standard for construction in flood hazard areas; and
 - (iv) include minor technical changes.

12.0 Adoption of BCA 2014

- (a) The 2014 edition of the BCA was adopted by the Commonwealth, States and Territories as set out in [Table 12.0](#).

Table 12.0 History of adoption of BCA 2014

Administration	Adoption Date
Australian Government	1 May 2014
Australian Capital Territory	1 May 2014
New South Wales	1 May 2014
Northern Territory	1 May 2014
Queensland	1 May 2014
South Australia	1 May 2014
Tasmania	1 May 2014
Victoria	1 May 2014
Western Australia	1 May 2014

- (b) The purpose of BCA 2014 is to—
- (i) update references to other documents; and
 - (ii) quantify slip resistance on stair treads in Class 1 buildings; and
 - (iii) relocate the energy efficiency provisions for heated water systems to NCC Volume Three - Plumbing Code of Australia; and

HISTORY OF AMENDMENTS

- (iv) expand the energy efficiency heating options for swimming pools and associated spa pools; and
- (v) include a new acceptable construction practice for hardboard cladding; and
- (vi) include minor technical changes.

13.0 Adoption of BCA 2015

- (a) The 2015 edition of the BCA was adopted by the Commonwealth, States and Territories as set out in [Table 13.0](#).

Table 13.0 History of adoption of BCA 2015

Administration	Adoption Date
Australian Government	1 May 2015
Australian Capital Territory	1 May 2015
New South Wales	1 May 2015
Northern Territory	1 May 2015
Queensland	1 May 2015
South Australia	1 May 2015
Tasmania	1 May 2015
Victoria	1 May 2015
Western Australia	1 May 2015

- (b) The purpose of BCA 2015 is to—
- (i) update references to other documents; and
 - (ii) include a Verification Method for structural reliability; and
 - (iii) include a Verification Method for weatherproofing of external walls; and
 - (iv) include revised Acceptable Construction Practice for termite management systems.

LIST OF AMENDMENTS

LIST OF AMENDMENTS

CONTENTS

LIST OF AMENDMENTS

List of Amendments Housing Provisions (Volume Two)

LIST OF AMENDMENTS

LIST OF AMENDMENTS - NCC 2015 - HOUSING PROVISIONS

This set of notes has been prepared by the Australian Building Codes Board to assist NCC users in identifying changes incorporated in the 2015 edition of the Housing Provisions (Volume Two of the NCC).

The notes provide a description of major changes made from the previous edition of the Housing Provisions.

While the Australian Building Codes Board has attempted to include all major changes made from the previous edition of the Housing Provisions, the Board does not give any warranty nor accept any liability in relation to the contents of this list of amendments.

Reference	Changes and Commentary	
Part 1.1		
1.1.1.2	The following definitions have been inserted or amended:	
	Cavity wall	A new defined term has been inserted as a consequence of including Verification Method V2.2.1.
	Direct fix cladding wall	A new defined term has been inserted as a consequence of including Verification Method V2.2.1.
	Swimming pool	The defined term has been amended to include any structure or excavation designed, manufactured or adapted to be used as a swimming pool, whether it is used for swimming or not.
	Unique wall	A new defined term has been inserted as a consequence of including Verification Method V2.2.1.
1.1.6(c) and (d)	New Subclauses (c) and (d) have been included to clarify that parts of buildings with different classifications in the NCC must comply with the requirements for each nominated classification.	
1.1.8	Clause 1.1.8 has been restructured. The content of the clause has not changed.	
Part 1.4		
Table 1.4.1	The following references have been inserted or amended:	
	AS 1397	Amdt 1 to AS 1397 'Continuous hot dip metallic coated sheet steel and strip - coatings of zinc and zinc alloyed with aluminium and magnesium' has been referenced.
	AS 1668.2	Amdt 1 to AS 1668 Part 2 'Mechanical ventilation in buildings' has been referenced.
	AS 1684.2	Amdt 2 to AS 1668 Part 2 'Residential timber-framed construction' has been referenced.
	AS 2047	The 2014 edition of AS 2047 'Windows and external glazed doors in buildings' has been referenced.
	AS/NZS 2179.1	The 2014 edition of AS/NZS 2179 Part 2 'Specifications for rainwater goods, accessories and fasteners - Metal shape or sheet rainwater goods and metal accessories and fasteners' has been referenced.

LIST OF AMENDMENTS

Reference	Changes and Commentary	
	AS 3660.1	The 2014 edition of AS 3660.1 'Termite management - New building work' has been referenced. The 2000 edition of AS 3660.1 has been retained for a 24 month transition period.
	AS 3660.3	The 2014 edition of AS 3660.3 'Assessment criteria for termite management systems' has been referenced as a consequence of new provisions for termite management systems.
	AS 3700	Amdt 1 to AS 3700 'Masonry structures' has been referenced.
	AS 3786	The 2014 edition of AS 3786 'Smoke alarms' has been referenced. The 1993 edition of AS 3786 has been retained for a 24 month transition period.
	AS/NZS 4284	The 2008 edition of AS/NZS 4284 'Testing of building facades' has been referenced as a consequence of the inclusion of the new Verification Method for weatherproofing of external walls.
	NASH Standard	The 2014 edition of the NASH Standard 'Steel Framed Construction in Bushfire Areas' has been referenced.
	NASH Standard	The 2014 edition of the NASH Standard Part 2 'Residential and Low-Rise Steel Framing — Design Solutions' has been referenced.
State and Territory variations	ISO 10077-1	The 2006 edition of ISO 10077-1 'Thermal performance of windows, doors and shutters — Calculation of thermal transmittance — Part 1: General' has been referenced as a consequence of the inclusion of energy efficiency provisions for taking window treatments into account in certain scenarios in the Australian Capital Territory.
	AS 1603.3	The 1996 edition of AS 1603 Part 3 'Automatic fire detection and alarm systems — Heat alarms' has been referenced as a consequence of the inclusion of the new provisions for garage top dwellings in New South Wales.
	AS/NZS 4013	Reference to AS/NZS 4013 'Domestic solid fuel burning appliances — Method for determination of flue gas emission' has been deleted as it is no longer referenced in Tasmania.
Part 2.1		
V2.1.1	A new Verification Method has been inserted to verify compliance with the Performance Requirements P2.1.1(a), (b) and (c). V2.1.1 is a means for verifying the structural reliability of structural components and connections.	
P2.1.2 State and Territory variation	A South Australian variation has been inserted to remove the Performance Requirement for construction of buildings in flood hazard areas pending further research on flood events in South Australia.	

LIST OF AMENDMENTS

Reference	Changes and Commentary
Part 2.2	
V2.2.1	A new Verification Method has been inserted as an option to verify compliance with Performance Requirement P2.2.2. V2.2.1 is a means for verifying if a proposed external wall system prevents the penetration of water, as required by P2.2.2, but does not exclude the other assessment methods of 1.0.9.
Part 3.1	
3.1.1 State and Territory variation note	The New South Wales note has been amended to clarify that shoring and adequacy of excavation works are controlled by conditions of development consent.
3.1.3.0(c)	A new sub-clause (c) has been included to define chemicals acceptable for use in a termite management system.
3.1.3.0(c) State and Territory variation	The Northern Territory variation has been amended and renumbered (d) as a consequence of the amendment to the acceptable construction practice for termite management systems.
3.1.3	<p>The acceptable construction practice for termite management systems has been restructured and amended. The changes include the following:</p> <ul style="list-style-type: none"> · A new application table 3.1.3.1 to identify the type of termite management system applicable to a particular floor construction. · New provisions for sheet material. · The adoption of a revised edition of AS 3660.3.
Part 3.2	
3.2.2.1 State and Territory variation note	The New South Wales note has been amended to clarify that shoring and adequacy of excavation works are controlled by conditions of development consent.
Part 3.4	
3.4.2.0 and 3.4.2.1	The acceptable construction manual and acceptable construction practice provisions have been amended to include the NASH Standard Part 2 'Residential and Low-Rise Steel Framing — Design Solutions'.
Part 3.6	
3.6.0(a) and (b)	Sub clause (a) and (b) have been amended to reflect the changes in the scope of the new edition of AS 2047.
3.6.1(f) and (g)	Sub clause (f) and (g) have been amended to reflect the changes in the scope of the new edition of AS 2047.
Part 3.7	
3.7.1.7 Explanatory information	Explanatory information has been provided to clarify that a deck is not considered an unroofed terrace and a pergola is an unroofed structure for the purposes of considering allowable encroachments for fire separation.

LIST OF AMENDMENTS

Reference	Changes and Commentary
3.7.3.0(b) State and Territory variation	The Tasmanian variation has been deleted as the emission standards of solid fuel heaters is covered by other legislation.
3.7.4.0(d) and Explanatory Information State and Territory variation	A new New South Wales subclause (d) has been inserted to exclude the use of NASH Standard 'Steel Framed Construction in Bushfire Areas' in BAL — FZ in New South Wales.
3.7.4.0(a) State and Territory variation	The Tasmanian subclause (a) has been amended to exclude the use of NASH Standard 'Steel Framed Construction in Bushfire Areas' in BAL — FZ in Tasmania.
3.7.4.2(a)(i) State and Territory variation	The Tasmanian sub-clause (a)(i) has been amended to remove the requirement for flow rate and pressure considerations for fire hydrants serving Class 1 buildings in designated bushfire prone areas in Tasmania.
Part 3.8	
3.8.2.2(f)	For consistency with similar provisions in Volume One, the minimum 2 m ceiling height has been applied to landings and ramps, in addition to stairways.
Part 3.9	
3.9.1.3(g) State and Territory variation.	A Tasmanian variation has been inserted to retain the unquantified slip-resistance provisions relating to stairway treads.
3.9.2.2(a) and (b)	Sub-clause (a) and (b) have been amended and restructured for improved usability. The term 'balustrade or other barrier' has been simplified to 'barrier'. The term has also been changed where it appears in other provisions.
3.9.2.3(f)	Sub-clause (f) has been amended to clarify that the opening requirements for wire barriers only apply to required barriers.
Part 3.10	
3.10.1.0(d)(iv)	Sub-clause (d)(iv) has been amended to include the NASH Standard Part 2 'Residential and Low-Rise Steel Framing — Design Solutions'.
3.10.3. State and Territory variation.	A new South Australian variation has been inserted to remove the Deemed-to-Satisfy provisions for construction of buildings in flood hazard areas pending further research on flood events in South Australia.
Part 3.11	
3.11.3 Explanatory information	Explanatory information has been provided to clarify the assignment of Importance Levels to different building types.
3.11.6(a)(ii)	Subclause (a)(ii) has been amended to include the NASH Standard Part 2 'Residential and Low-Rise Steel Framing — Design Solutions'.

LIST OF AMENDMENTS

Reference	Changes and Commentary
3.11.6(i)(B)	Sub clause (i)(B) has been amended to reflect the changes in the scope of the new edition of AS 2047.
Part 3.12	
Table 3.12.1.1a	The minimum Total R-Values for roofs have been adjusted to reflect research findings on the effect of roof solar absorptance levels.
3.12.1.5(a)(ii)	The provision has been amended to apply the slab edge and underslab insulation requirements to in-screed heating or cooling systems.
Table 3.12.1.5 Notes	The notes to the table have been expanded to clarify that the R-Value attributable to an in-slab or in-screed heating or cooling system is ignored when calculating the R-Value of the slab.
3.12.1.5(e)	A new sub-clause and explanatory information have been included to exempt insulation requirements for slabs containing in-screed heating or cooling systems in small areas.
Table 3.12.5.1 Explanatory information	Table 3.12.5.1 and explanatory information have been amended to provide more representative piping insulation R-values for target values and product availability. The explanatory information also clarifies that, where piping has a 'significant' inherent R-value, it may be used to offset the pipe insulation requirements.
Commonwealth Appendix	
Footnote	The Footnote listing other legislation has been updated.
Australian Capital Territory Appendix	
ACT 7.1	A new provision has been included for energy efficiency provisions for alterations and additions to existing buildings.
Footnote	The Footnote listing other legislation has been updated.
New South Wales Appendix	
NSW 1	A new Addition has been included to provide certain requirements for the construction of a dwelling over a non-appurtenant private garage.
NSW P2.6.1(b)	Buildings in climate zones 2 and 5, where the only means of air-conditioning is by using an evaporative cooler, have been added to 'Limitations' and permanent openings associated with the use of a gas appliance have been clarified.
NSW 3.12.1.1(d)	'In-screed' heating or cooling systems have been included alongside the reference to an 'in-slab' heating or cooling system. Sub-clauses (i) and (ii) have been updated to reflect changes to the national energy efficiency provisions.
NSW 3.12.3(b)	Sub-clause (b), which lists exemptions from application of NSW 3.12.3, has been extended to include buildings in climate zones 2 and 5 where the only means of air-conditioning is by using an evaporative cooler. Permanent openings associated with the use of a gas appliance have also been clarified.
Footnote	The Footnote listing other legislation has been updated.
Northern Territory Appendix	
Footnote	The Footnote listing other legislation has been updated.
South Australia Appendix	

LIST OF AMENDMENTS

Reference	Changes and Commentary
Footnote	The Footnote listing other legislation has been updated.
Victorian Appendix	
Footnote	The Footnote listing other legislation has been updated.
History of BCA Adoption	
13.0	New provision added in order to set out the adoption date of the 2015 edition of the Housing Provisions in each State and Territory and to summarise the purpose of the changes from the 2014 edition.



Australian Building Codes Board
Building Australia's Future

Australian Building Codes Board
GPO Box 9839
Canberra ACT 2601
www.abcb.gov.au